

To protect your hearing (AVLS)
The AVLS (Automatic Volume Limiter System) function keeps down the maximum volume to protect your ears.

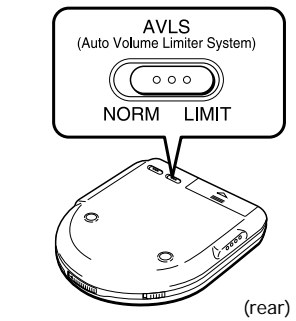

Set AVLS to LIMIT. The AVLS indication appears.



Note

- If you use the SOUND function and the AVLS function at the same time, sound may be distorted. If this happens, turn down the volume.

To resume playing from the point you stopped the CD (Resume Play)

Normally, every time you stop and play, playing starts from the beginning of the CD. The resume play function, however, lets you listen to from the point at which you last turned off the player.

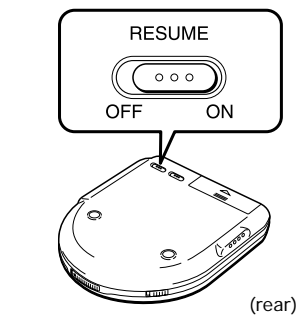

Set RESUME to ON.

To cancel resume play, set RESUME to OFF.

Notes

- Even if RESUME is set to ON, playing starts from the beginning when you open the lid.
- The resume point may be inaccurate by about 30 seconds.

To turn off the beep

You can turn off the beep that sounds as you operate your player.

Disconnect the power source (AC power adaptor, rechargeable battery or alkaline batteries). While you press and hold down **■**, connect the power source again. To make the beep sound again, disconnect the power source, and then connect it without pressing **■**.

Connecting to other stereo equipment

You can listen to the CD through other stereo equipment or record a CD on a cassette tape or a MiniDisc. Refer to the instruction manual of the other equipment for details. Before making connections, turn off each piece of equipment.

Using the connecting cord

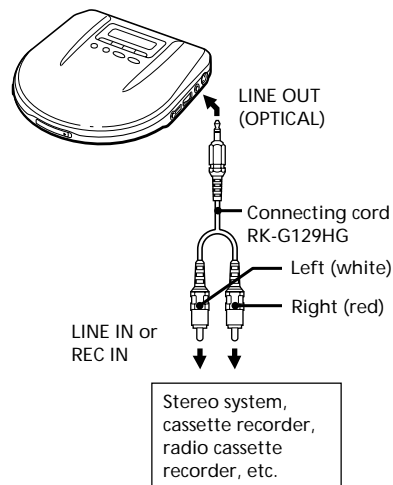

Note

- When you use a connecting cord, the SOUND function will be disabled.

Using the optical digital connecting cord

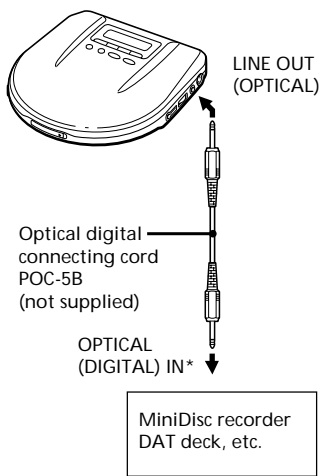

*If the OPTICAL (DIGITAL) IN jack is square-shaped, use the POC-5AB optical digital connecting cord instead.

Notes on connecting to other stereo equipment

- Before you play the CD, turn down the volume of the connected equipment so as not to damage the connected speakers.
- The beep sound is not output from the LINE OUT (OPTICAL) jack.
- When you connect other equipment to the LINE OUT (OPTICAL) jack of this player, adjust the volume on the connected equipment.
- When you record a CD on a cassette tape using a tape recorder that has the blank search function, release the ESP function. If the ESP function is on, the blank search function does not work.
- Use the AC power adaptor for recording. If you use the rechargeable batteries or dry batteries as a power source, batteries may become weak during recording.

Recording with optical digital connection

Record a CD on a MiniDisc, DAT, etc., according to the following procedure.

- 1 Press **▶▶** on the player to start play.
- 2 Press **▶▶** again to pause.
- 3 Press **◀◀/▶▶** to select the track you want to record.
- 4 Press **●** (record) on the MiniDisc recorder, DAT recorder, etc.
- 5 Press **▶▶** on the player to release pause.

Notes

- Connect the optical digital connecting cord while the player is in stop mode.
- If you record without pausing the player, some CD may have problem with recording the first track number correctly.
- The SOUND function works on the output from the **◊**/REMOTE jack, but does not work on that from the LINE OUT (OPTICAL) jack.
- When use an optical digital connecting cord, the ESP function will be disabled.

Playing a CD in a car

You can use your player in a car by connecting it to the car cassette deck.

You cannot use the car mount plate for this player. When you use the player in a car, install it securely in a location which does not interfere your driving.

To connect your player to a car cassette deck, you need the following accessories:

- Car connecting pack CPA-9
 - Car battery cord DCC-E245 or,
 - Car battery cord with car connecting pack DCC-E26CP
- Refer to the instruction manual of each accessory for details.

Notes

- Do not put the player on the dashboard.
- Do not leave the player in a car parked under sunlight.
- Use a Sony car connecting pack for reducing noise.
- Use only the car battery cord listed in the recommended accessories. If you use any other car battery cord, smoke, fire or malfunction may occur.

Switched ignition function (when using the car battery cord)

With this feature, your player stops automatically when you turn off the engine of the car. (This function is not possible with some cars depending on the model).

Using the supplied remote control

You can use the remote control as the wired remote control.

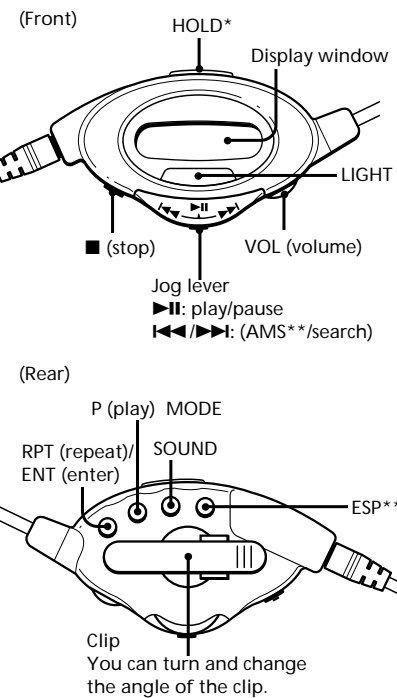

- * When you are not using the remote control, slide HOLD in the direction of the arrow to prevent any accidental operations. To unlock, slide HOLD back.
- ** Automatic Music Sensor
- *** Electronic Shock Protection

Note

- Use only the supplied remote control. You cannot operate this player with the remote control supplied with other models.

Power Sources

Using rechargeable batteries

Charge the rechargeable batteries before using them for the first time. Use the NH-DM2AA or NC-DMAA rechargeable batteries for this player. You cannot use any other rechargeable batteries.

- 1 Open the lid of the battery compartment.

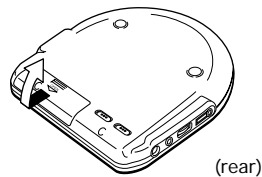

- 2 Insert two rechargeable batteries by matching the ⊕ and ⊖ to the diagram inside the battery compartment and close the lid.

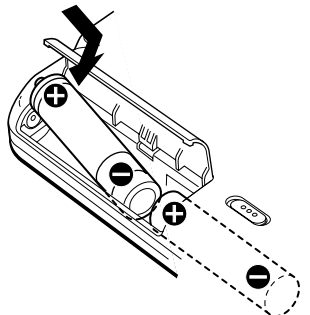

- 3 Connect the AC power adaptor. The indication "CHG" lights up. Charge for about 4 hours. (If the battery has been already charged, "CHG" and flash.)

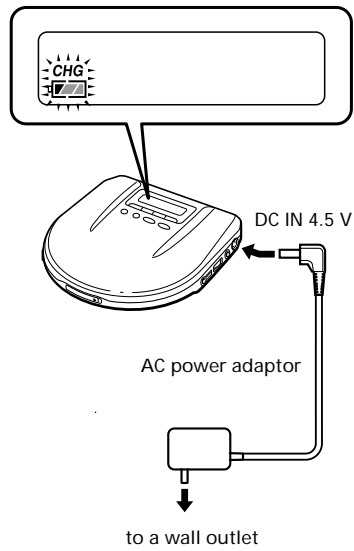

- 4 When fully charged, "CHG" disappears. Disconnect the AC power adaptor.

To take out the rechargeable batteries

Take out the batteries in the proper way as illustrated inside the lid or shown below.

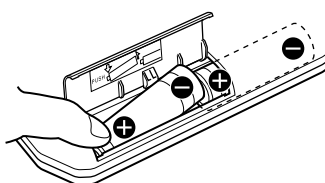

When to charge the rechargeable batteries

When the rechargeable batteries become weak, indication appears in the display. If the "Lo bōtt" appears in the display, charge the rechargeable batteries, because the batteries are used up. To keep the original battery capacity for a long time, recharge the batteries when the batteries are used up (discharged).

When carrying the rechargeable battery

Make sure to use the supplied battery carrying case. If you carry the rechargeable battery with a metal object, short circuit, smoke or fire may occur.

Notes

- Charging time varies depending on how the rechargeable battery is used.
- If the battery is new or has not been used for a long time, it may not be charged completely until you charge and discharge it several times.
- If the battery life becomes shorter by about half, replace it with Sony NH-DM2AA or NC-DMAA rechargeable battery. Do not use any other rechargeable battery.
- The supplied rechargeable batteries are only for this player. You cannot use them for other models.

Using dry batteries

Insert the batteries properly in the same way as the rechargeable batteries.

- 1 Disconnect the AC power adaptor and open the lid of the battery compartment.

- 2 Insert two LR6 (size AA) alkaline batteries by matching the ⊕ and ⊖ to the diagram inside the battery compartment and close the lid.

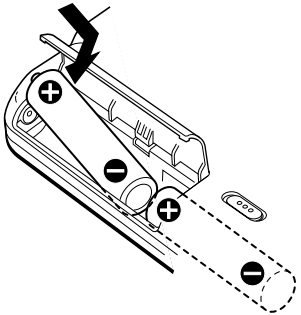

Note

- Do not use manganese batteries for this player.

To take out the dry batteries

Take out the batteries properly in the same way as the rechargeable batteries.

When to replace the dry batteries

When the battery becomes weak, indication appears in the display. If the batteries are used up, "Lo bōtt" appears in the display. Replace all the batteries with new ones.

Notes

- Do not charge the dry batteries.
- Do not mix new batteries with old ones.
- Do not use different types of batteries together.
- When the batteries are not to be used for a long time, remove them.
- If the battery leakage occurs, wipe off any deposit in the battery compartment, and install new batteries.

Battery life (approx. hours) (EIAJ*)

Battery life varies depending on how the player is used.

When using	ESP function	
	off	on
Two NH-DM2AA (charged for about 4 hours**)	13	12
Two NC-DMAA (charged for about 4 hours**)	8	7
Two Sony alkaline batteries LR6SG	23	21

*Measured value by the standard of EIAJ (Electronic Industries Association of Japan) (When you use the player on a flat and stable place; When you do not use the optical digital connecting cord)
**Charging time varies depending on how the rechargeable battery is used.

How to attach the battery compartment lid

If the battery compartment lid is detached by an accidental drop, excessive force, etc., attach it as illustrated in the numbered order.

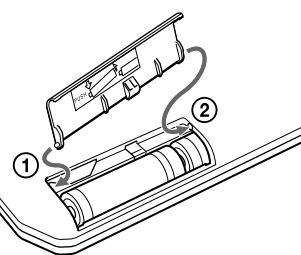

Additional Information

Precautions

On safety

- Should any solid objects or liquid fall into the player, unplug it and have it checked by qualified personnel before operating it any further.
- Do not put any foreign objects in the DC IN 4.5 V (external power input) jack.

On power sources

- When you are not using the player for a long time, disconnect all power sources from the player.

On the AC power adaptor

- Use only the supplied AC power adaptor. If your player is not supplied with it, use AC-E45HG AC power adaptor. Do not use any other AC power adaptor.

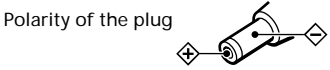

- To unplug the AC power adaptor from the wall outlet, grasp the adaptor itself, do not pull its cord.

On dry and rechargeable batteries

This player is designed so that it cannot charge any other rechargeable batteries or dry batteries for safety reasons.

The supplied rechargeable batteries (NH-DM2AA) or optional rechargeable batteries (NC-DMAA)

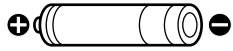

Other rechargeable batteries or dry batteries

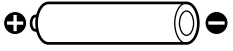

When you replace the rechargeable batteries with new ones, make sure to use the NH-DM2AA/NC-DMAA rechargeable batteries.

- Do not throw the batteries into fire.
- Do not carry the batteries with coins or other metallic objects. It can generate heat if the positive and negative terminals of the battery are accidentally contacted by a metallic object.
- Do not mix rechargeable batteries with dry batteries.

On the player

- Keep the lens on the player clean and do not touch it. If you do so, the lens may be damaged and the player will not operate properly.
- Do not put any heavy object on top of the player. The player and the CD may be damaged.
- Do not leave the player in a location near heat sources, or in a place subject to direct sunlight, excessive dust or sand, moisture, rain, mechanical shock, unlevelled surface, or in a car with its windows closed.
- If the player causes interference to the radio or television reception, turn off the player or move it away from the radio or television.
- Do not wrap the player in a cloth or blanket during use as it may cause malfunction or serious accidents.

On headphones/earphones

Road safety

Do not use headphones/earphones while driving, cycling, or operating any motorized vehicle. It may create a traffic hazard and is illegal in some areas. It can also be potentially dangerous to play your headsets at high volume while walking, especially at pedestrian crossings. You should exercise extreme caution or discontinue use in potentially hazardous situations.

Preventing hearing damage

Avoid using headphones/earphones at high volume. Hearing experts advise against continuous, loud and extended play. If you experience a ringing in your ears, reduce volume or discontinue use.

Caring for others

Keep the volume at a moderate level. This will allow you to hear outside sounds and to be considerate to the people around you.

Maintenance

To clean the lens

Clean the lens with a lens cleaning kit KK-DM1.

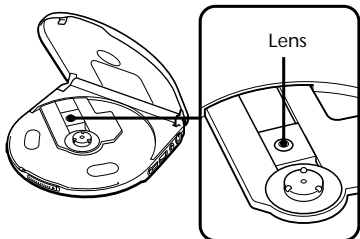

To clean the casing

Use a soft cloth slightly moistened in water or a mild detergent solution. Do not use alcohol, benzine or thinner.

Troubleshooting

Should any problem persist after you have made these checks, consult your nearest Sony dealer.

The CD does not play or "no disc" appears in the display though a CD is placed in the display.

- The CD is dirty or defective.
- Insert the CD with the label side up.
- Moisture condensation has occurred. Leave the player aside for several hours until the moisture evaporates.
- The lens is dirty.
- Close the lid of the player and the battery compartment firmly.
- Make sure the batteries are inserted correctly.
- Connect the AC power adaptor to a wall outlet securely.

When you press ▶▶, "00" appears in the display for a moment, and disappears. The CD does not play.

- Rechargeable battery or dry batteries are used up. Charge the rechargeable battery or replace dry batteries with new ones.

No sound, or noise is heard.

- Connect the plugs firmly.
- Plugs are dirty. Clean the plugs with a dry soft cloth periodically.

"Hi disc" appears in the display.

- Use only the supplied AC power adaptor or recommended AC power adaptor AC-E45HG (not supplied).
- Use only the car battery cord listed in the Recommended accessories.

"Hold" appears in the display when you press a button.

- The buttons are locked. Slide HOLD back.

"Lo bōtt" appears in the display when you press a button.

- The rechargeable batteries are used up completely. Connect the AC power adaptor and charge the batteries.
- The dry batteries are use up. Replace them with new ones.

The battery life is short.

- Manganese batteries are used. Use alkaline batteries.
- Replace the batteries with new ones.

The volume is limited to a certain level even if you attempt to turn it up.

- AVLS selector is set to LIMIT. Set it to NORM.
- The earphones/headphones are connected to the LINE OUT jack.
- Connect them to the **◊**/REMOTE jack.

During recording with optical digital connection, the track number cannot be recorded correctly.

- Record the track number again using the MiniDisc recorder, DAT recorder, etc.
- Record again according to the procedure shown in the section "Connecting to other stereo equipment."

Specifications

CD player section

System Compact disc digital audio system

Laser diode properties

Material: GaAlAs
Wavelength: λ = 780 nm
Emission duration: Continuous
Laser output: Less than 44.6 μW (This output is the value measured at a distance of 200 mm from the objective lens surface on the optical pick-up block with 7 mm aperture.)

Error correction

Sony Super Strategy Cross Interleave Reed Solomon Code

D-A conversion

1-bit quartz time-axis control

Frequency response

20 - 20,000 Hz ±1dB (measured by EIAJ CP-307)

Output (at 4.5 V input level)

Headphones (stereo minijack)
15 mW + 15 mW at 16 ohms
Line output (stereo minijack)
Output level 0.7 V rms at 47 kilohms
Recommended load impedance over 10 kilohms
Optical digital output (optical output connector)
Output level: -21 - -15 dBm
Wavelength: 630 - 690 nm at peak level

General

Power requirements

For the area code of the model you purchased, check the upper left side of the bar code on the package.

- Two Sony NH-DM2AA rechargeable batteries: 2.4 V DC
- Two Sony NC-DMAA rechargeable batteries: 2.4 V DC
- Two LR6 (size AA) batteries: 3 V DC
- AC power adaptor (DC IN 4.5 V jack): U2/CA2/E92 model: 120 V, 60 Hz
CED/CEX/CET/EE1/E13 model: 220 - 230 V, 50/60 Hz
CEK model: 230 - 240 V, 50 Hz
EA3 model: 110 - 240 V, 50/60 Hz
AU2 model: 240 V, 50 Hz
JE.W/E33 model: 100 - 240 V, 50/60 Hz
HK2 model: 220 V, 50/60 Hz
CN2/AR1 model: 220 V, 50 Hz
- Sony DCC-E245 car battery cord for use on car battery: 4.5 V DC

Dimensions (w/h/d) (without projecting parts and controls)

Approx. 131.8 × 23.9 × 142.0 mm

(5 1/4 × 3/32 × 5 3/8 in.)

Mass (without rechargeable batteries)

Approx. 200 g (7.0 oz)

Operating temperature

5°C - 35°C (41°F - 95°F)

Supplied accessories

For the area code of the model you purchased, check the upper left side of the bar code on the package.

- AC power adaptor (1)
- Headphones with remote control (1)^{*1}
- Earphones with remote control (1)^{*2}
- Rechargeable batteries (2)
- AC plug adaptor (1)^{*3}
- Battery carrying case (1)
- Carrying case (1)

^{*1} Supplied with U2 model

^{*2} Not supplied with U2 model

^{*3} Supplied with JE.W, E33 and E13 models

Design and specifications are subject to change without notice.

For US customers

AC power adaptor supplied is not intended to be serviced. Should the AC power adaptor cease to function in its intended manner, during the warranty period, the adaptor should be returned to your nearest Sony Service Center or Sony Authorized Repair Center for replacement, or after warranty period, it should be discarded.

Optional accessories

- Car connecting pack CPA-9
- Car battery cord with car connecting pack DCC-E26CP
- Car battery cord DCC-E245
- Active speaker system SRS-A21, SRS-A41, SRS-A71
- Rechargeable battery NH-DM2AA, NC-DMAA (2P)
- Connecting cord RK-G129HG
- Optical digital connecting cord POC-5B, POC-10B, POC-15B, POC-5AB, POC-10AB, POC-15AB
- AC power adaptor AC-E45HG
- Stereo headphones MDR-35, MDR-E848L*
- * For the customers supplied with the headphones with remote control: When connecting optional headphones to the supplied remote control, use only headphones with stereo mini plugs. You cannot use headphones with micro plugs.

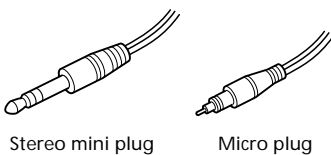

Your dealer may not handle some of the above listed accessories. Please ask the dealer for detailed information about the accessories in your country.