



Quick Setup Guide/快速設定指南

DAV-DZ790K

1 Connecting the speakers/連接揚聲器

Connect the speaker cords to match the color of the SPEAKER jacks of the unit.
將揚聲器導線連接到本機上對應顏色的 SPEAKER 插孔。

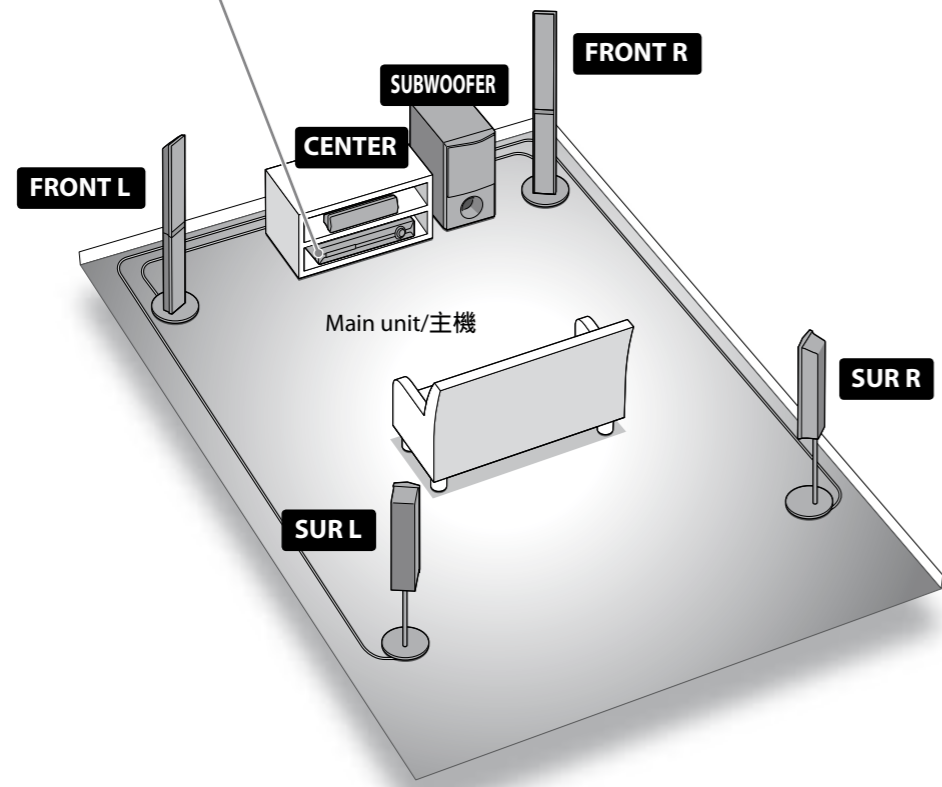
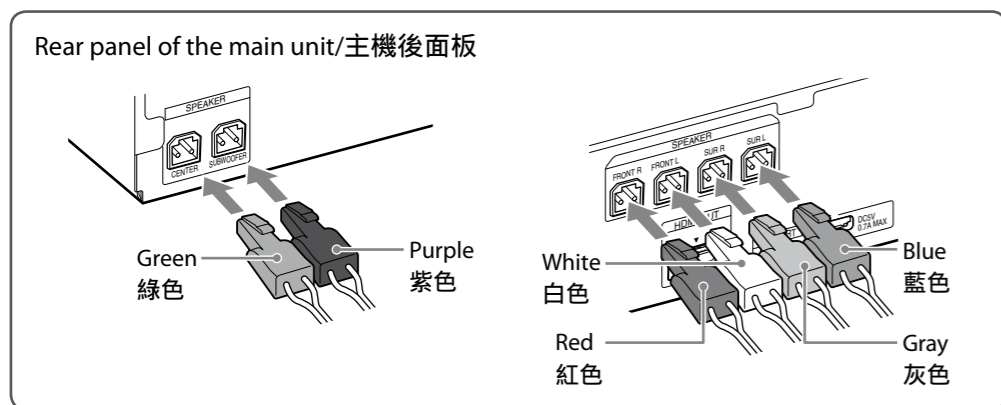

To connect speaker cords to the speaker/將揚聲器導線連接到揚聲器

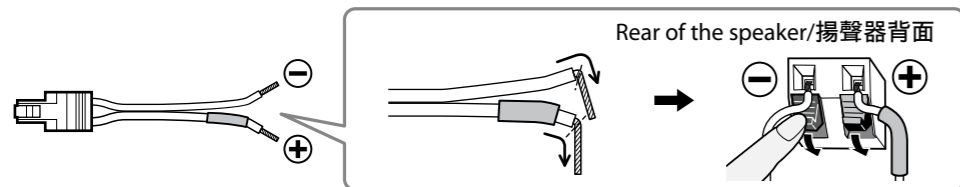

2 Connecting the TV/連接電視機

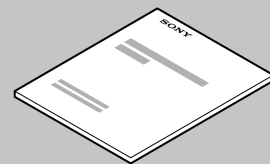

For details, see the Operating Instructions.
詳細說明請參閱使用說明書。

Depending on the jacks on your TV, select the video and audio connection method.
視電視機上的插孔而定，選擇視頻和聲音的連接方法。

Video connection method/視頻連接方法

Method 1/方法 1

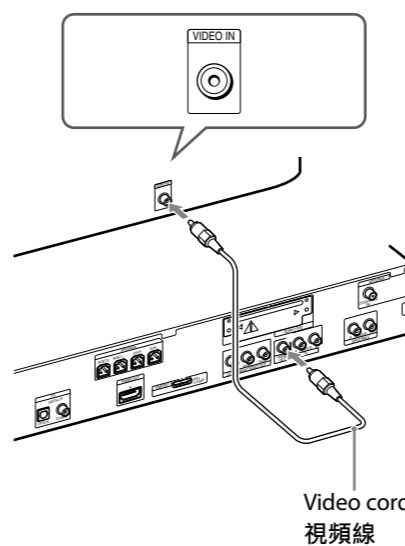

Method 2/方法 2

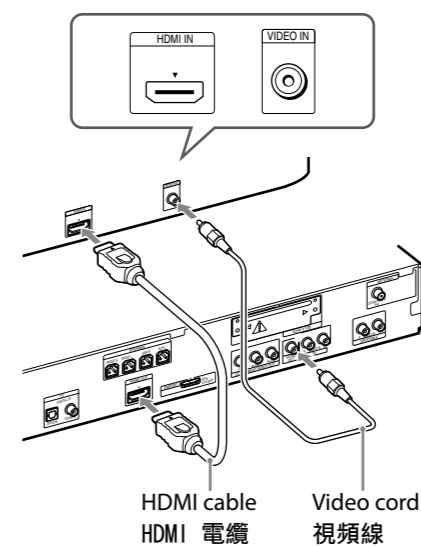

Method 3/方法 3

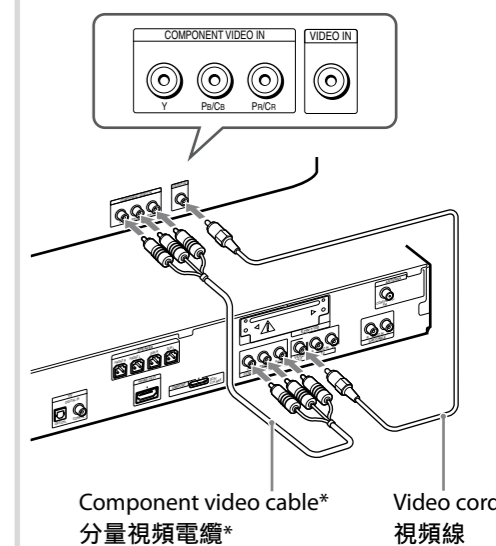

*Not supplied/不提供

Audio connection method/聲音連接方法

Method 1/方法 1

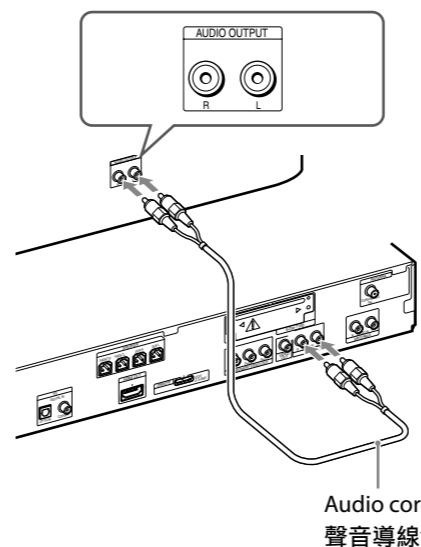

Method 2/方法 2

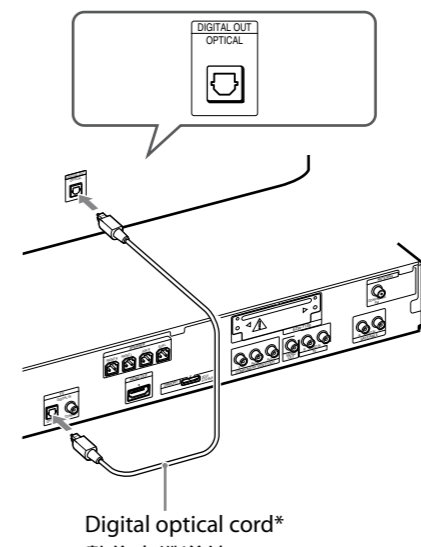

Method 3/方法 3

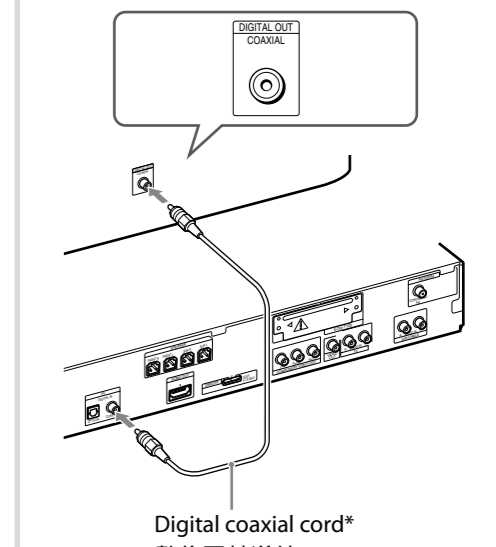

*Not supplied/不提供

3 Performing the Quick Setup/執行快速設定

Note
Do not insert a disc before performing the Quick Setup.

注意
請勿於執行快速設定之前插入光碟。

- 1 Connect the AC power cord.**
The shape of the wall outlet differs depending on the area.
連接交流電源線。
電源插座的形狀視地區而異。

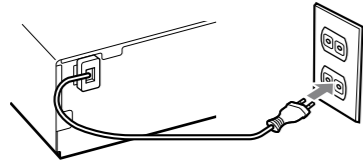

- 2 Turn on the power of the main unit and TV.**
打開主機與電視機的電源。

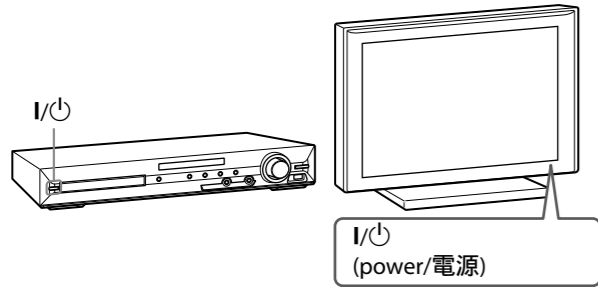

- 3 Switch the input selector on your TV to display "SONY Home Theatre System."**
切換電視機上的輸入選擇器以顯示 "SONY Home Theatre System"。

- 4 Set each following item, using ←/↑/↓/→ and +.**
使用 ←/↑/↓/→ 鍵和 + 鍵，設定以下每個項目。

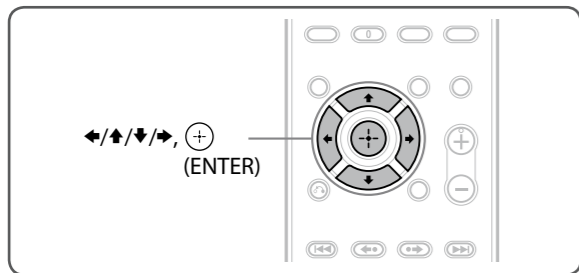

Note
Displayed items vary depending on the area.

注意
視地區而定，顯示項目會有不同。

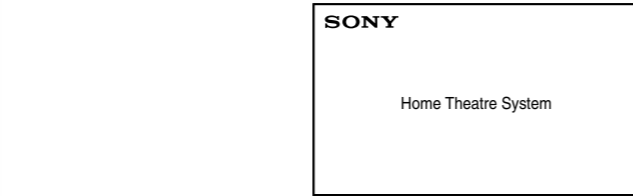

Select an on-screen language.
選擇畫面語言。

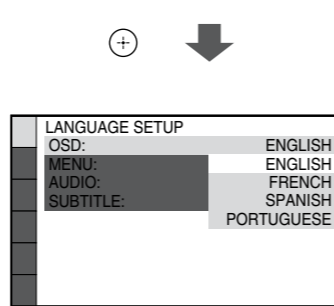

Select the aspect ratio of the connected TV.
選擇所連接電視機的縱橫比。

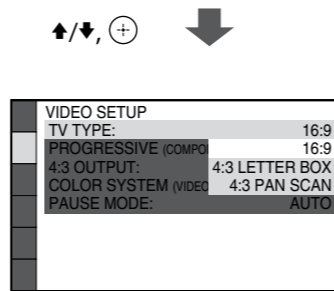

Select [ON] when you connect the main unit and the TV with an HDMI cable.
使用 HDMI 電纜連接主機與電視機時，請選擇 [ON]。

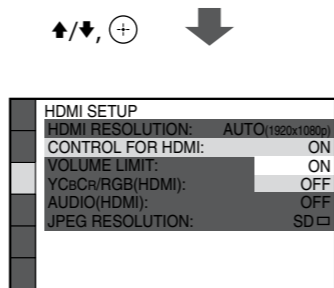

Select the speaker formation.
選擇揚聲器架構。

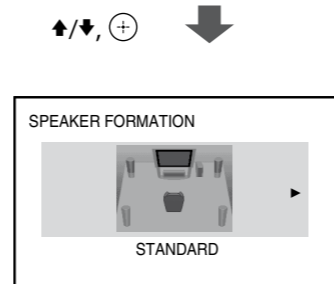

Connect the calibration mic and set it at the listening position.

連接校正麥克風並設定至聆聽位置。

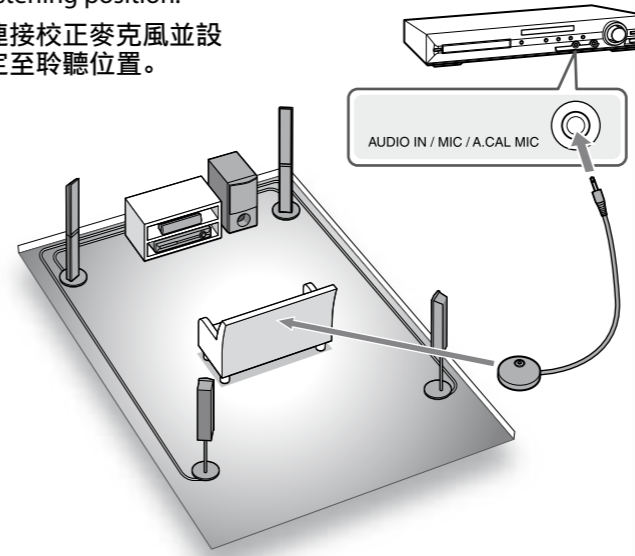

Select [YES] to perform [AUTO CALIBRATION].
選擇 [YES] 執行 [AUTO CALIBRATION]。

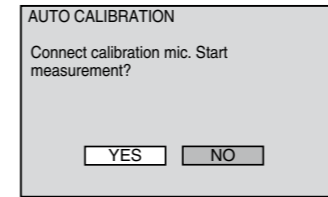

Select [YES] to save the measurement results.
選擇 [YES] 儲存測量結果。

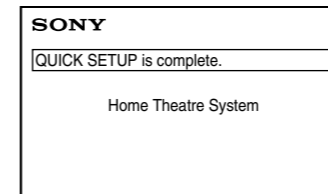
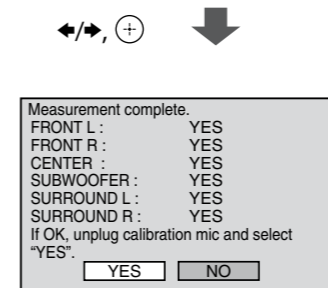

Listening to TV sound from all speakers/聆聽所有揚聲器的電視機聲音

- 1 Press FUNCTION to display "TV."**
按 FUNCTION 鍵顯示 "TV"。

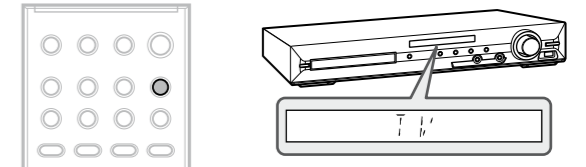

- 2 Press SYSTEM MENU.**
按 SYSTEM MENU 鍵。

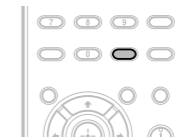

- 3 Press ↑/↓ to display "DEC. MODE," then press +.**
按 ↑/↓ 鍵顯示 "DEC. MODE"，然後按 + 鍵。

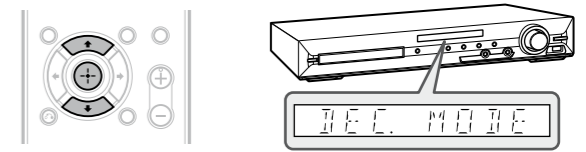

- 4 Press ↑/↓ to display "PRO LOGIC," then press +.**
按 ↑/↓ 鍵顯示 "PRO LOGIC"，然後按 + 鍵。

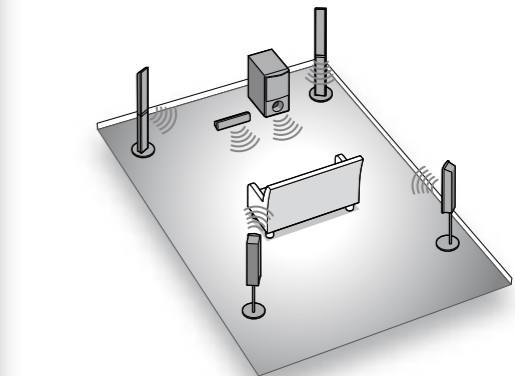
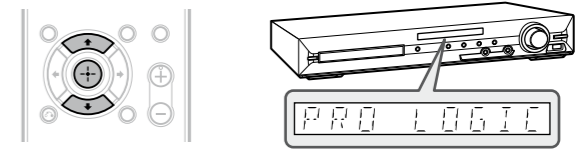

- 5 Press SYSTEM MENU to exit the menu.**
按 SYSTEM MENU 鍵退出菜單。