

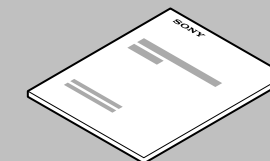

Quick Setup Guide/快速設定指南

DAV-TZ210



For details, refer to the Operating Instructions.
詳細資訊，請參閱使用說明書。

1 Connecting the speakers/連接揚聲器

Connect the speaker cords to match the color of the **SPEAKERS** jacks of the unit.

將揚聲器導線連接到本機上對應顏色的 **SPEAKERS** 插孔。

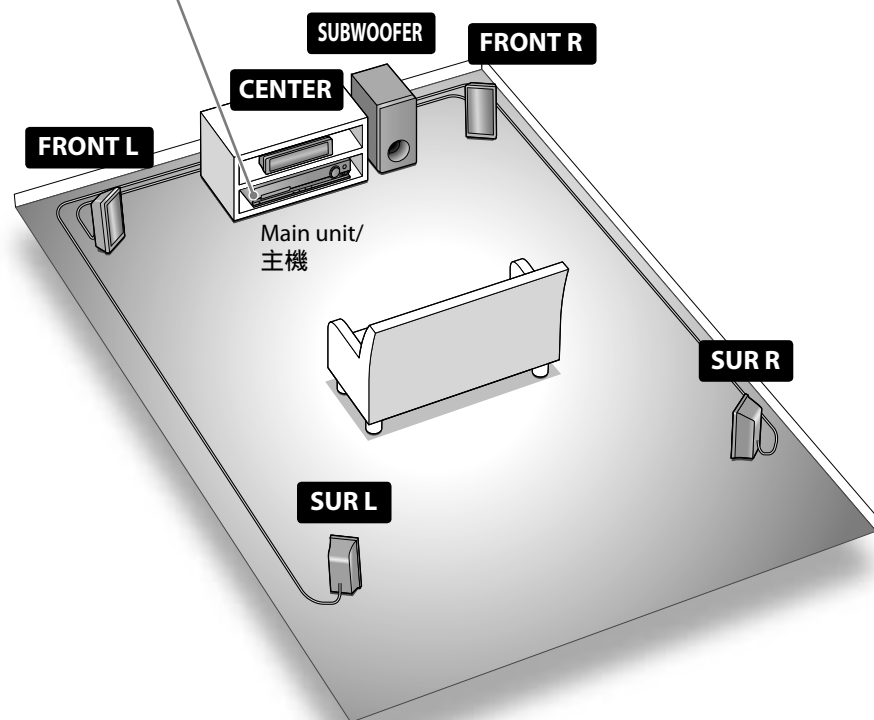
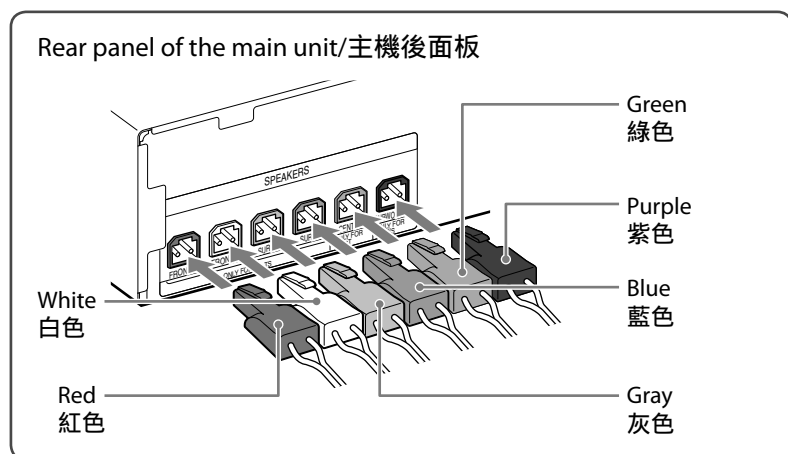

To connect speaker cords to the speaker/

將揚聲器導線連接到揚聲器

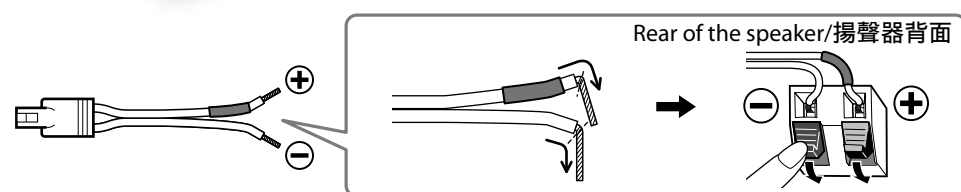

2 Connecting your TV/set-top box/連接電視機/機上盒

Depending on the jacks on your TV or set-top box, select the video and audio connection method.

視電視機或機上盒上的插孔而定，選擇視頻和聲音連接方法。

Connecting the video to your TV/將視頻連接至電視機

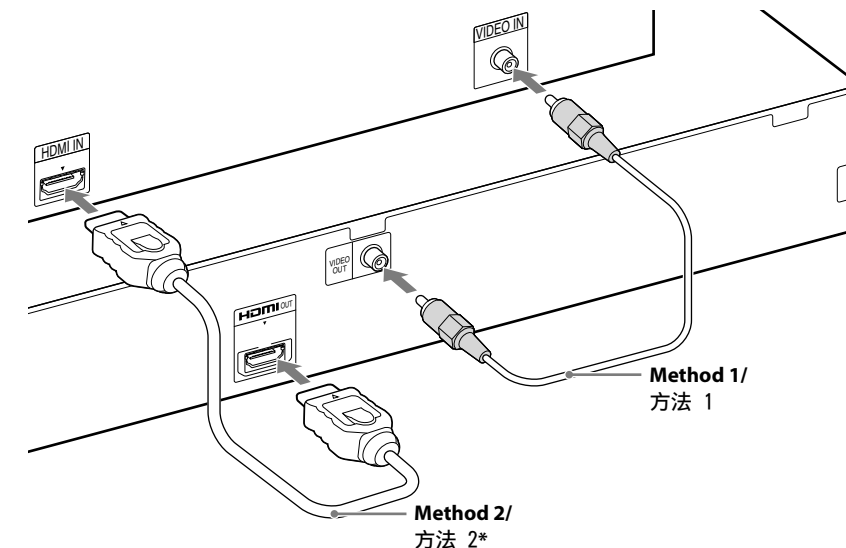
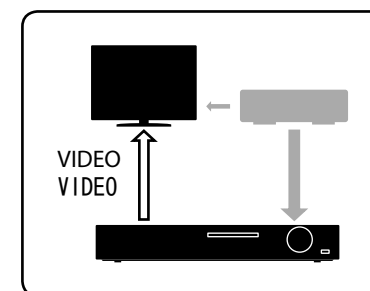

*Supplied with Singapore, Indonesian, Malaysian, and Filipino models only./僅新加坡、印尼、馬來西亞和菲律賓機型提供。

Connecting the audio from your set-top box/連接來自機上盒的聲音

If you do not use a set-top box, refer to "Connecting your TV/set-top box" in the Operating Instructions.

如果不使用機上盒，請參閱使用說明書中的“連接電視機 / 機上盒”。

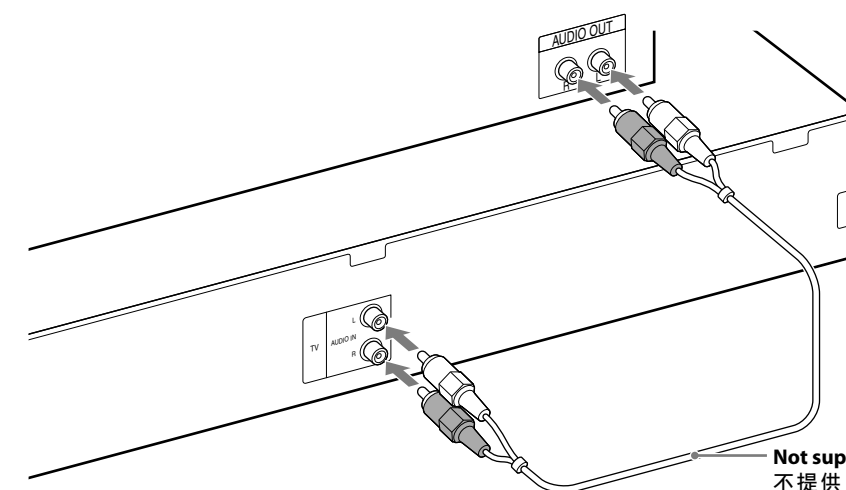
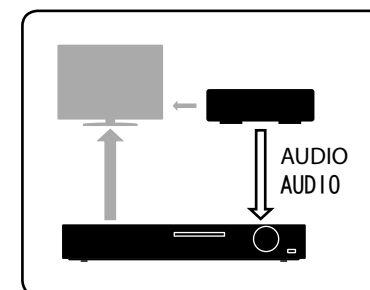

3 Performing the Quick Setup/執行快速設定

Note
Do not insert a disc before performing the Quick Setup.

注意
請勿於執行快速設定之前插入光碟。

1 Connect the AC power cord.

The shape of the wall outlet differs depending on the area.

連接交流電源線。
電源插座的形狀視地區而異。

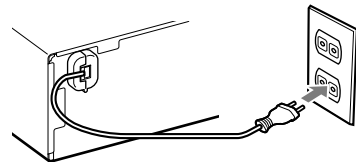

2 Turn on the power of the main unit and TV.

打開主機與電視機的電源。

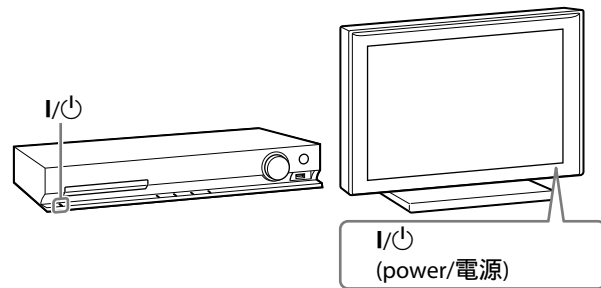

3 Switch the input selector on your TV to display "SONY Home Theatre System."

切換電視機上的輸入選擇器以顯示 "SONY Home Theatre System"。

4 Set each following item, using ←/↑/↓/→ and +.

Displayed items vary depending on the area.

使用 ←/↑/↓/→ 鍵和 + 鍵，設定以下每個項目。
視地區而定，顯示項目會有不同。

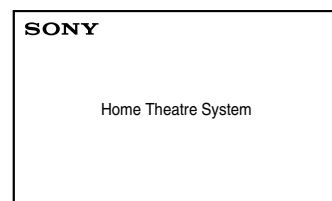
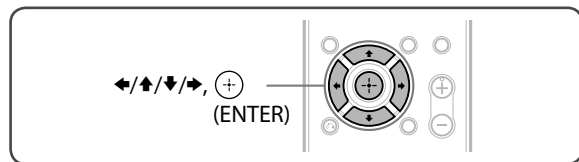

Select an on-screen language.

選擇畫面語言。

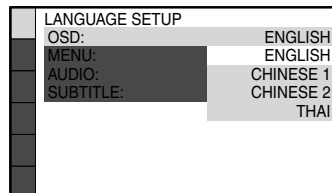

Select the aspect ratio of the connected TV.

選擇所連接電視機的縱橫比。

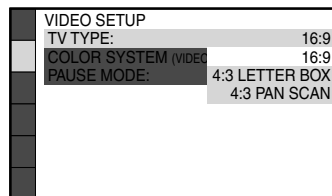

Select [ON] when you connect the main unit and the TV with an HDMI cable.

使用 HDMI 電纜連接主機與電視機時，請選擇 [ON]。

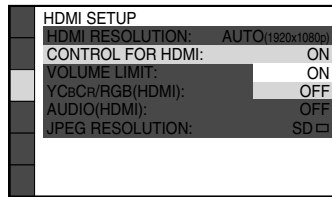

Select the speaker formation.

選擇揚聲器架構。

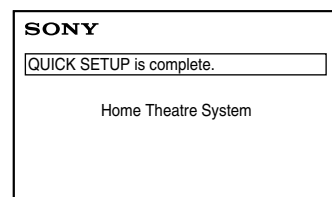
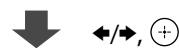
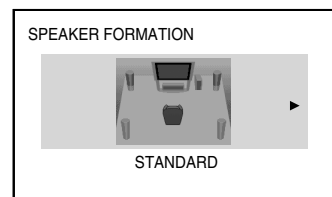

Listening to TV sound from all speakers/聆聽所有揚聲器的電視機聲音

1 Press TV.

按 TV 鍵。

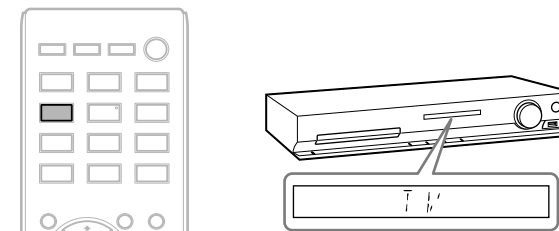

2 Press SYSTEM MENU.

按 SYSTEM MENU 鍵。

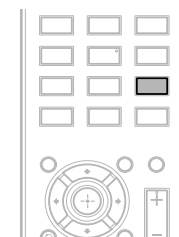

3 Press ↑/↓ to display "SUR.SETTING" then press +.

按 ↑/↓ 鍵顯示 "SUR.SETTING"，然後按 + 鍵。

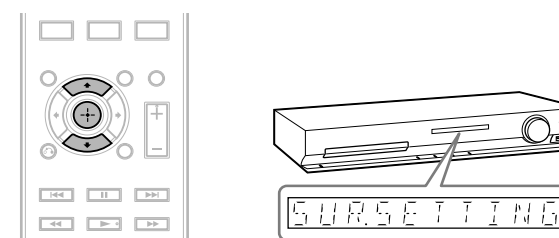

4 Press ↑/↓ to display "PRO LOGIC," then press +.

按 ↑/↓ 鍵顯示 "PRO LOGIC"，然後按 + 鍵。

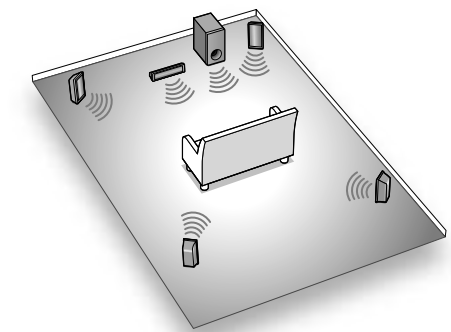
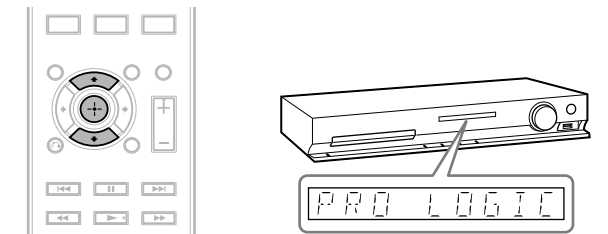

5 Press SYSTEM MENU to exit the menu.

按 SYSTEM MENU 鍵退出菜單。

