

Micro HiFi Component System

Operating Instructions



CMT-VP11

WARNING

To prevent fire or shock hazard, do not expose the unit to rain or moisture.

To avoid electrical shock, do not open the cabinet. Refer servicing to qualified personnel only.

Do not install the appliance in a confined space, such as a bookcase or built-in cabinet.

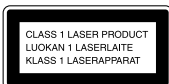



This appliance is classified as a CLASS 1 LASER product. The CLASS 1 LASER PRODUCT MARKING is located on the rear exterior.

This system is equipped with the Dolby* B-type noise reduction system.

* Dolby noise reduction manufactured under license from Dolby Laboratories Licensing Corporation. “DOLBY” and the double-D symbol  are trademarks of Dolby Laboratories Licensing Corporation.

This system can play the following discs

	VIDEO CDs	Audio CDs
Disc logo		
Contents	Audio + Video (moving pictures)	Audio
Disc size	12 cm/8 cm	12 cm/8 cm
Play time	74 min./20 min.	74 min./20 min.

Note on VIDEO CDs

This system conforms to VIDEO CDs without PBC functions (Ver. 1.1) and VIDEO CDs with PBC functions (Ver. 2.0) of VIDEO CD standards. You can enjoy two kinds of playback according to the disc type.

Disc type	You can
VIDEO CDs without PBC functions (Ver. 1.1 discs)	Enjoy video playback (moving pictures) as well as audio CDs.
VIDEO CDs with PBC functions (Ver. 2.0 discs)	Play interactive software using menu screens displayed on the TV screen (menu playback), in addition to the video playback function of VIDEO CDs without PBC functions. Moreover, you can play high or standard quality still picture.

* PBC = Play Back Control

Table of Contents

Getting Started

Step 1: Hooking up the system	4
Step 2: Setting the time	7
Step 3: Presetting radio stations — Preset ..	8
Connecting optional components	9

Basic Operations

Playing a VIDEO CD	12
Playing a CD — Normal Play	13
Recording from a CD/VIDEO CD to a tape — CD Synchro Recording	14
Listening to the radio — Preset Tuning ..	16
Recording from the radio	17
Playing a tape	19
Singing along: Karaoke	20

The VIDEO CD/CD Player

Playing a VIDEO CD with PBC functions (Ver. 2.0) — PBC Play	22
Checking the remaining playing time	23
Using the on-screen display	24
Resuming VIDEO CD playback from the point last stopped at — Resume Play	27
Playing CD/VIDEO CD tracks repeatedly — Repeat Play	28
Playing CD/VIDEO CD tracks in random order — Shuffle Play	28
Playing CD/VIDEO CD tracks in a favorite order — Program Play	29

The Tape Deck

Recording to a tape manually	30
Recording your favorite CD/VIDEO CD tracks to a tape — Program Edit	31

Other Features

Adjusting the sound	33
Falling asleep to music — Sleep Timer ..	33
Waking up to music — Daily Timer	34
Timer-activated recording of radio programs — REC Timer	35

Additional Information

Precautions	37
Troubleshooting	38
Specifications	40
Glossary	42
Parts identification for the remote	42
Index	Back cover

Step 1: Hooking up the system

Follow steps **1** through **6** of the procedure below to hook up your system using the supplied cords and accessories.

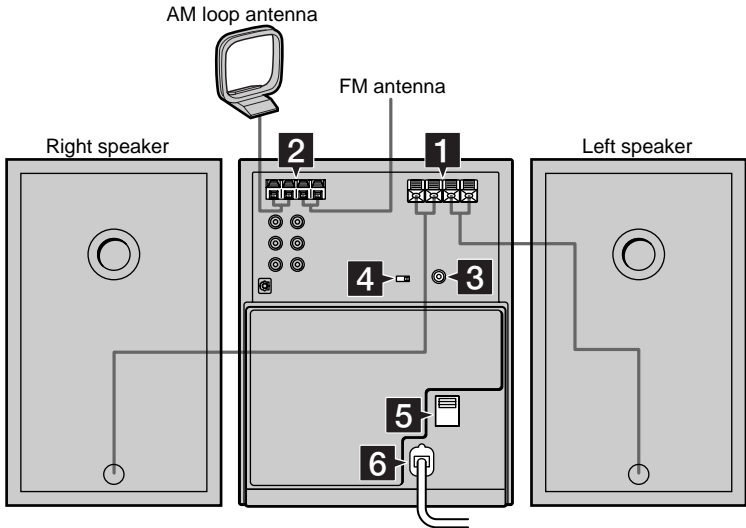

1 Connect the speakers.

Connect the right and left speaker cords to the SPEAKER terminals as shown below.

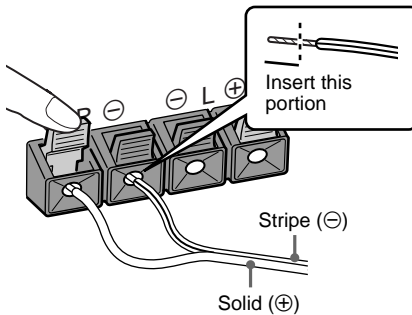

Note

Keep the speaker cords away from the antennas to prevent noise.

2 Connect the FM and AM antennas.

Set the AM loop antenna up before connecting it.

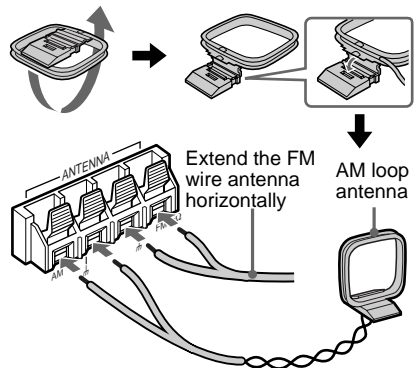

- 3** Connect the VIDEO OUT jack to the video input jack on your TV with the supplied video connecting cord.

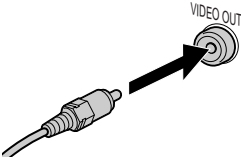

When using a TV

Turn on your TV and set the input selector to video input so you can view the pictures from the system.

- 4** Set SYSTEM SELECT (color system) to PAL or NTSC depending on the color system of your TV.

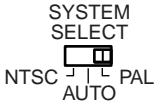

If your TV automatically changes the color system according to the input signal:

Set SYSTEM SELECT to AUTO.

The video signal will be output in the color system of the VIDEO CD being played back.

If the color system of your TV is NTSC:

Set SYSTEM SELECT to NTSC.

When this system is selected, video images recorded in the PAL system will be stretched vertically, and the upper and lower parts of the picture will be cut off.

If the color system of your TV is PAL:

Set SYSTEM SELECT to PAL (the factory setting).

When this system is selected, video images recorded in the NTSC system will be stretched horizontally, and the upper and lower parts of the screen will be masked in black.

Note

Be sure to turn off the system before you change the SYSTEM SELECT setting.

- 5** For models with a voltage selector, set VOLTAGE SELECTOR to the local power line voltage.



- 6** Connect the power cord to a wall outlet. If the plug does not fit the wall socket, detach the supplied plug adaptor (only for models equipped with an adaptor).

continued

Step 1: Hooking up the system (continued)

Inserting two size-AA (R6) batteries into the remote

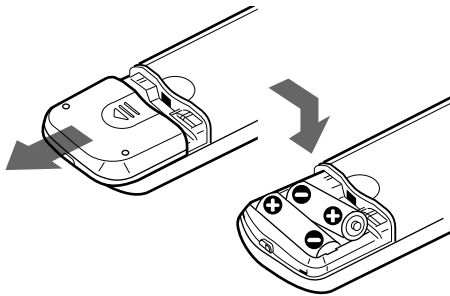

Tip

With normal use, the batteries should last for about six months. When the remote no longer operates the system, replace both batteries with new ones.

Notes on batteries

- Make sure the battery poles (plus/minus) are properly oriented.
- Do not use a new battery with an old one.
- Do not use different types of batteries together.
- If you do not use the remote for a long period of time, remove the batteries to prevent possible damage from battery leakage and corrosion.
- Do not use a battery that is leaking.
- If a battery has leaked, clean the battery compartment and replace all the batteries.
- Do not place the remote in an extremely hot or humid place.
- Do not expose the remote sensor to direct sunlight or lighting apparatuses. Doing so may cause a malfunction.

Using the remote

You can use the shaded buttons shown below to operate a Sony TV set.

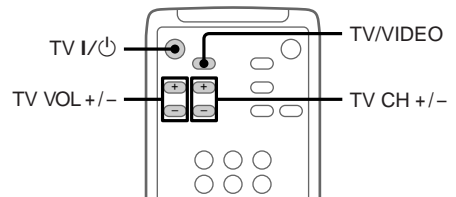

To	Press
Turn the TV on or off	TV I/⏻.
Switch the TV's video input	TV/VIDEO.
Change the TV channel	TV CH +/-.
Adjust the volume of the TV speaker(s)	TV VOL +/-.

Step 2: Setting the time

Before you can use the system's timer functions, set the internal clock.

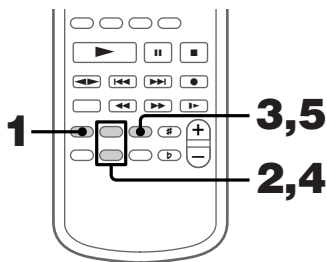

- 1 Press **TIMER SET**.

The hour indication flashes.

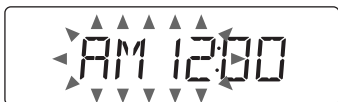

- 2 Press **+/-** repeatedly to set the hour.

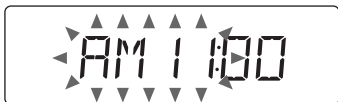

- 3 Press **ENTER**.

The minute indication flashes.



- 4 Press **+/-** repeatedly to set the minute.

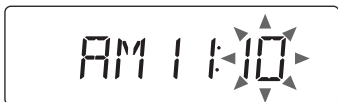

- 5 Press **ENTER**.

The clock will begin operating.

To reset the system clock

You can reset the system clock even when the system is on or off. To reset the time while the system is on, do the following:

- 1 Press **TIMER SET**.
- 2 Press **+/-** repeatedly until "SET CLOCK" appears, then press **ENTER**.
- 3 Repeat steps 2 to 5 in "Step 2: Setting the time".

Tip

If you make a mistake, start over from step 1.

Step 3: Presetting radio stations — Preset

The system can store a total of 30 preset stations (20 for FM and 10 for AM). This section explains how to tune in stations and preset them.

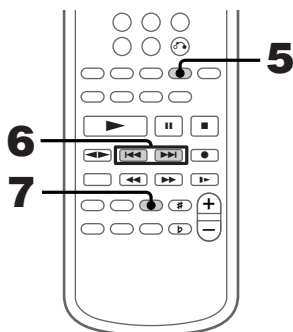
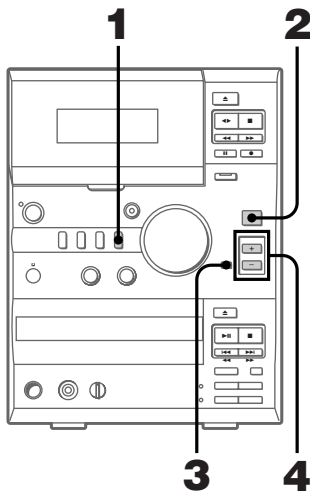

- 1** Press TUNER.
“TUNER” appears.

- 2** Press TUNER BAND to select FM or AM.

- 3** Press TUNING MODE repeatedly until “AUTO” appears.

- 4** Press TUNING +/-.
The frequency changes as the system scans for a station. Scanning stops automatically when a station is tuned in. At that time, “TUNED” and “STEREO” (for stereo programs only) appear.



- 5** Press MEMORY on the remote.
A preset number flashes.



- 6** Press <left><right> on the remote repeatedly to select the preset number that you want.



- 7** Press ENTER on the remote.
The station is stored to the selected preset number.

- 8** Repeat steps 2 through 7 to preset other stations.

To tune in a weak station

In step 3, press TUNING MODE repeatedly until “AUTO” and “PRESET” disappear, then press TUNING +/- repeatedly to tune in the station.

To change the preset number

Start over from step 2.

Tip

The preset stations are saved in the system’s memory for about two days even if you disconnect the power cord or a power failure occurs.

To change the AM tuning interval (not applicable on the Middle Eastern model)

The AM tuning interval is factory-preset to 9 kHz. To switch the AM tuning interval, tune in any AM station first, then turn off the system. Pressing TUNING + down, turn the system back on. When you change the interval, all the AM preset stations are erased. To change back to the original interval, tune in any AM station first, then turn off the system. Pressing TUNING – down, turn the system back on.

Connecting optional components

This section explains how to connect a variety of components to your system in order to enhance it. Refer to the instructions included with each component for details.

Connecting audio components

Connecting an MD deck for analog recording

You can connect an MD deck to the system with commercially available audio cords. Be sure to match the color-coded pins to the appropriate jacks. To listen to the MD deck after connecting it, press MD/VIDEO until “MD” appears.

To the audio input jacks on the MD deck

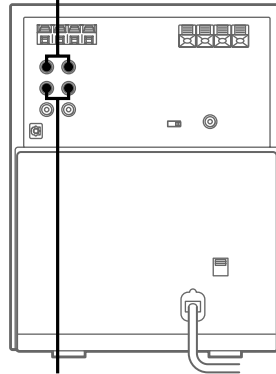

To the audio output jacks on the MD deck

continued

Connecting optional components (continued)

Connecting an MD deck for digital recording

By connecting an MD deck to the system with a commercially available optical cable, you can make a digital recording from a CD.

To the digital input connector
on the MD deck

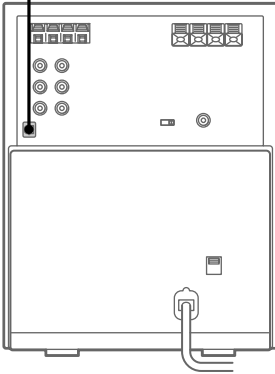

Note

You cannot make a digital recording from a VIDEO CD to an MD deck through an optical cable. You can, however, make an analog recording through an optional audio connected to the LINE OUT jacks. (See "Connecting an MD deck for analog recording.")

Connecting a VCR

You can connect a VCR to the system with a commercially available audio cord. Be sure to match the color-coded pins to the appropriate jacks. To listen to the VCR after connecting it, press MD/VIDEO until "VIDEO" appears.

By connecting the audio output jacks on your VCR to the VIDEO IN jacks using an optional audio cord, you can enjoy powerful stereo sound with the video playback.

Moreover, if you connect the audio input jacks on your VCR to the LINE OUT jacks, and connect the video input jack on your VCR to the VIDEO OUT jack using the supplied video connecting cord, you can record the audio and video signals from a VIDEO CD onto video tape.

To the audio input
jacks on the VCR

To the video input
jack on the VCR

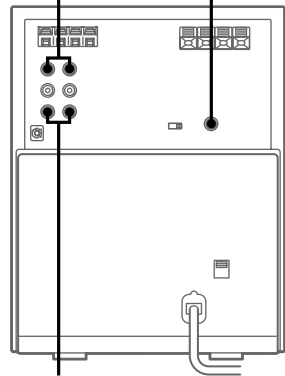

To the audio output
jacks on the VCR

Connecting headphones

Connect headphones to the PHONES jack.

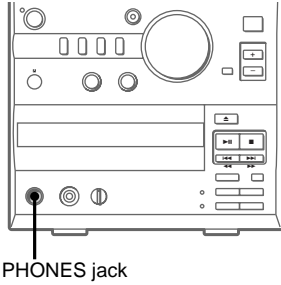

Connecting external antennas

You can connect an external antenna to your system to get better reception.

FM antenna

Connect a commercially available external FM antenna to the FM ANTENNA terminals as shown below. You may also connect a TV antenna for the same purpose.

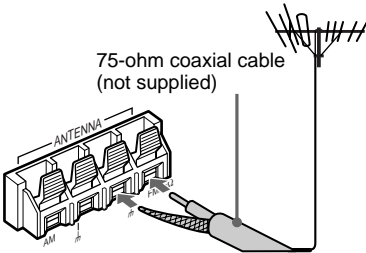

AM antenna

For the AM antenna, use a 6- to 15-meter, horizontally extended insulated wire, with one end connected to the AM ANTENNA terminals as shown below. Leave the supplied AM loop antenna connected.

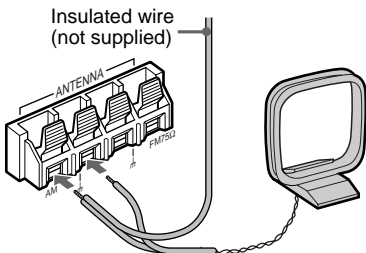

Playing a VIDEO CD

You can play both VIDEO CDs without PBC functions (Ver. 1.1) and VIDEO CDs with PBC functions (Ver. 2.0).

You can enjoy two kinds of playback according to the disc type.

To turn on the system, press I/⏻.

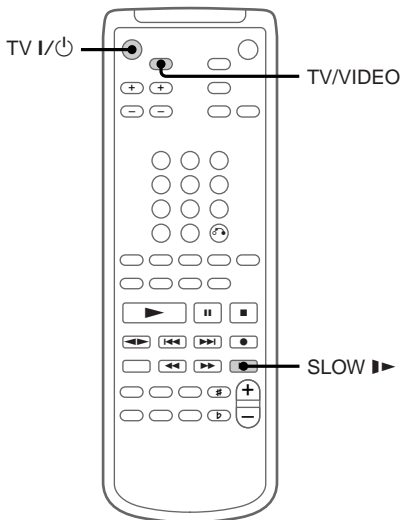
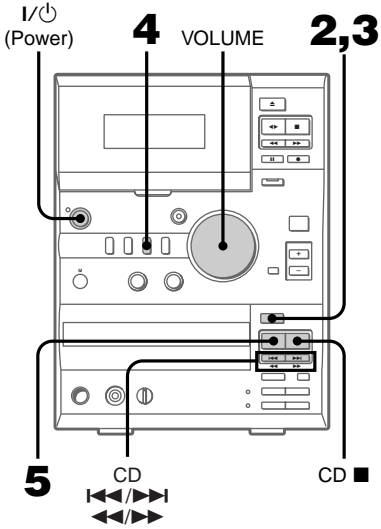

- 1 Turn on your TV and select the video input.

Refer to the operating instructions supplied with your TV for details.

- 2 Press CD EJECT ▲ and place a VIDEO CD on the disc tray.

The disc tray opens.

If the disc is not placed properly, it may not be recognized.

Place with the label side up. When you play a VIDEO CD single (8 cm VIDEO CD), place it on the inner circle of the tray.

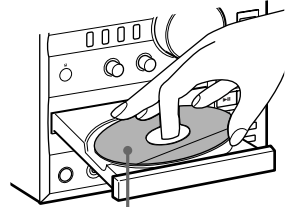

- 3 Press CD EJECT ▲ again to close the disc tray.

- 4 Press CD. "CD" appears.

- 5 Press CD ▶||. Playback starts.

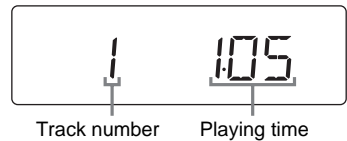

To	Do this
Stop playback	Press CD ■.
Pause	Press CD ► *1. Press again to resume playback.
Slow playback	Press SLOW ► on the remote. Each time you press this button, the playback speed changes as follows: <div style="text-align: center;"> </div>
Select a track or scene*2	Press CD ►► to go forward or CD ◀◀ to go back repeatedly.
Locate a desired point in a track or scene (Lock Search function)	During playback, press down CD ◀◀ or CD ►► until the system starts searching. ① Press once to start searching. ② Press again to increase the search speed. Each time you press the button, the search speed changes as follows: 1 (slow) → 2 (normal) → 3 (high) → 1 (slow) ... ③ Press CD ►► to stop searching at the desired point.
Remove or replace the VIDEO CD	Press CD EJECT ▲.
Adjust the volume	Turn VOLUME.

*1 The video image may be somewhat unstable.
 *2 Except during PBC playback of a VIDEO CD with PBC functions (Ver. 2.0). See page 22 for details on PBC playback.

- Tips**
- If you press CD ►|| when the power is off, the system automatically turns on and the VIDEO CD starts playing if there is a VIDEO CD on the disc tray (One Touch Play).
 - To switch to the VIDEO CD while listening to another source, press CD ►||. The VIDEO CD will automatically start playing. (Automatic Source Selection).
 - “NO DISC” appears in the display if there is no VIDEO CD on the disc tray.

Playing a CD – Normal Play

Do the procedure below to play a CD starting from the first track.
 To turn on the system, press I/⏻.

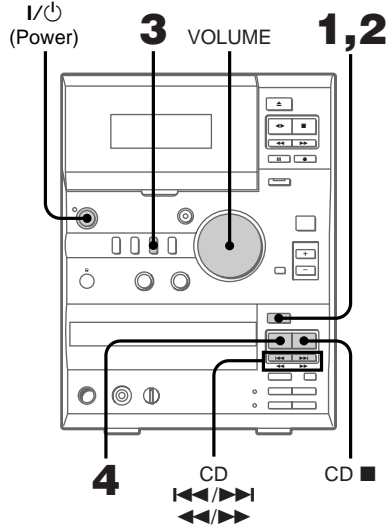

- 1** Press CD EJECT ▲ and place a CD on the disc tray.
The disc tray opens.

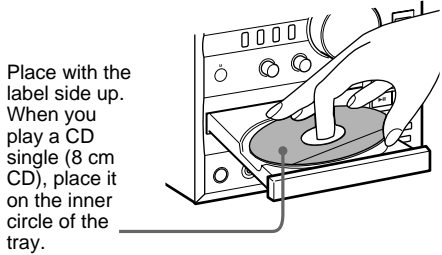

- 2** Press CD EJECT ▲ again to close the disc tray.

continued

Playing a CD (continued)

3 Press CD. “CD” appears.

4 Press CD ►||. Playback starts.

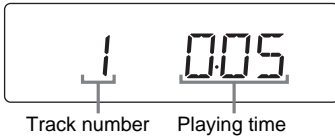

To	Do this
Stop playback	Press CD ■.
Pause	Press CD ► . Press again to resume playback.
Select a track	During playback or pause, press CD ◀◀ (to go back) or CD ▶▶ (to go forward) repeatedly until you find the desired track.
Locate a desired point in a track (Lock Search function)	During playback, press down CD ◀◀ or CD ▶▶ until the system starts searching. Press CD ► to stop searching at the desired point.
Remove or replace the CD	Press CD EJECT ▲.
Adjust the volume	Turn VOLUME.

Tips

- If you press CD ►|| when the power is off, the system automatically turns on and the CD starts playing if there is a CD on the disc tray (One Touch Play).
- To switch to the CD while listening to another source, press CD ►||. The CD will automatically start playing (Automatic Source Selection).
- “NO DISC” appears in the display if there is no CD on the disc tray.

Recording from a CD/VIDEO CD to a tape

— CD Synchro Recording

The CD Synchro Recording function makes it easy to record from a CD/VIDEO CD to a tape. Both Type I (normal) and Type II (CrO₂) tapes can be used. To record only the tracks that you want, it is convenient to use the Program Edit function (see page 31).

To turn on the system, press I/⏻.

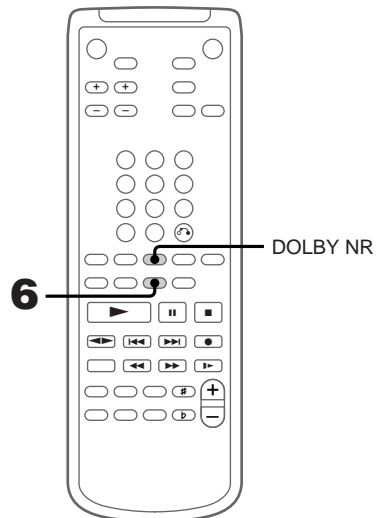
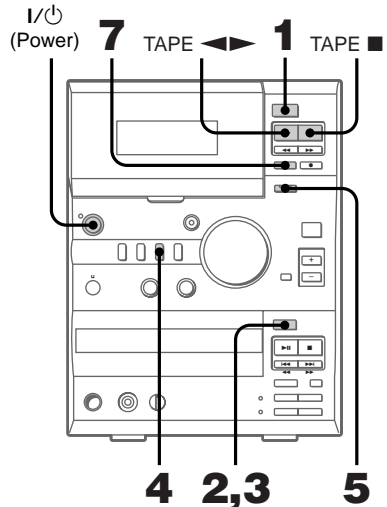

- 1 Press TAPE EJECT ▲ and insert a recordable tape into the cassette holder.

With the side you want to record on facing towards you

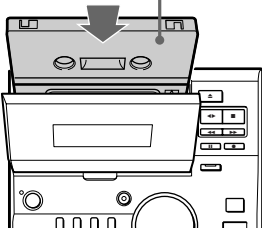

- 2 Press CD EJECT ▲ and place a CD/VIDEO CD on the disc tray.

Place with the label side up. When you play a CD/VIDEO CD single (8 cm CD/VIDEO CD), place it on the inner circle of the tray.

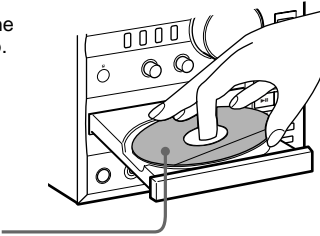

- 3 Press CD EJECT ▲ again to close the disc tray.

- 4 Press CD.
“CD” appears.

- 5 Press CD SYNC.

The tape stands by for recording and the VIDEO CD/CD stands by for playback. “REC” and “▶” (or “◀”) appear, and the CD SYNC indicator lights up.

- 6 Press DIR MODE on the remote repeatedly to select “→” to record on one side of the tape, or “↔” or “←→” to record on both sides.

- 7 Press TAPE II.
Recording starts.

To stop recording

Press TAPE ■.

Tips

- To record with the Dolby NR system on, press DOLBY NR on the remote before step 7. “DOLBY NR” appears.
- To start recording on the side facing away from you, after doing step 5, press TAPE ◀▶ until “REC▶” changes to “◀REC.”

Note

You cannot listen to another source during CD Synchro Recording.

Listening to the radio

— Preset Tuning

Presetting radio stations in the system's memory in advance makes it easy to tune in those stations later (see "Step 3: Presetting radio stations" on page 8).

To turn on the system, press I/⏻.

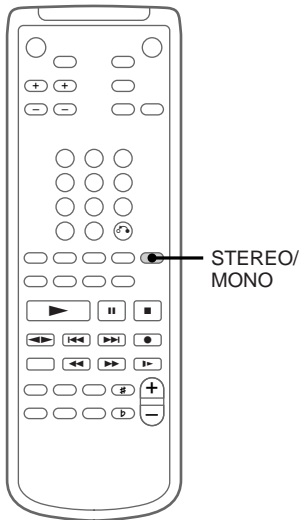
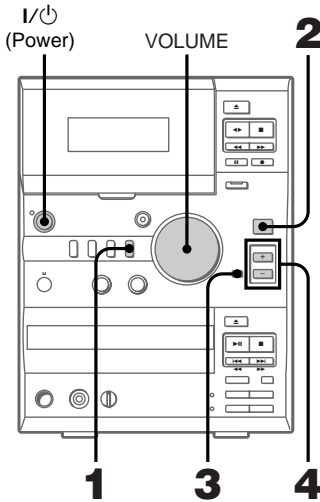

- 1 Press TUNER.
"TUNER" appears.
- 2 Press TUNER BAND to select FM or AM.
- 3 Press TUNING MODE repeatedly until "PRESET" appears.
- 4 Press TUNING +/- repeatedly to display the preset number of the desired station.

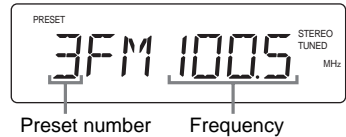

To	Do this
Turn off the radio	Press I/⏻.
Adjust the volume	Turn VOLUME.

To tune in a non-preset radio station

In step 3, press TUNING MODE repeatedly until "AUTO" and "PRESET" disappear, then press TUNING +/- repeatedly to tune in the desired station (Manual Tuning).

Tips

- If you press TUNER BAND when the power is off, the system automatically turns on and tunes in the station last received (One Touch Play).
- To switch to the radio while listening to another source, press TUNER BAND (Automatic Source Selection).
- If there is static during an FM broadcast, press STEREO/MONO on the remote until "MONO" appears. After "MONO" scrolls across the display, the frequency will appear. The broadcast will no longer be in stereo, but the reception will improve. Press this button again to restore the broadcast to stereo.
- To improve the reception, adjust the supplied antennas or connect an external antenna (see "Connecting external antennas" on page 11).

Recording from the radio

Do the procedure below to tune in a preset station (see page 16) and record from the radio to a tape. Both Type I (normal) and Type II (CrO₂) tapes can be used.

To turn on the system, press I/⏻.

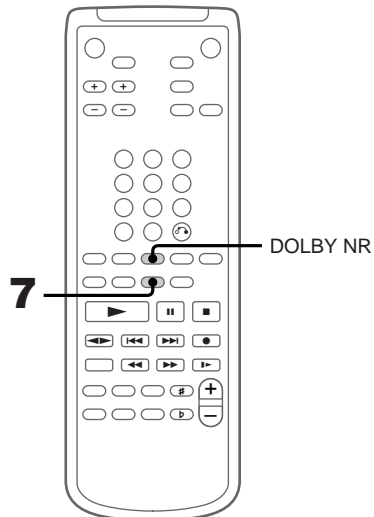
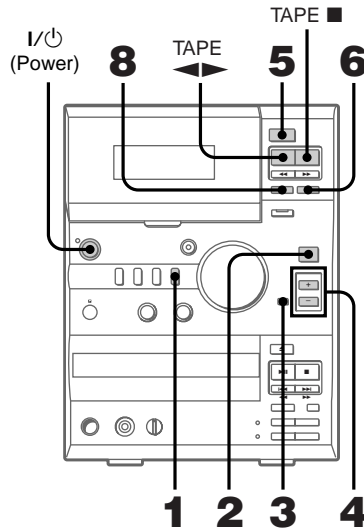

continued

Recording from the radio (continued)

- 1** Press TUNER.
“TUNER” appears.
- 2** Press TUNER BAND to select FM or AM.
- 3** Press TUNING MODE repeatedly until “PRESET” appears.
- 4** Press TUNING +/- repeatedly to display the preset number of the desired station.

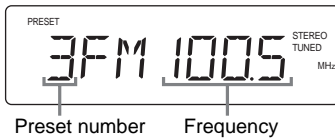

- 5** Press TAPE EJECT ▲ and insert a recordable tape into the cassette holder.

With the side you want to record on facing towards you

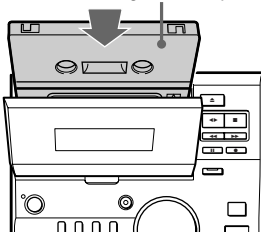

- 6** Press REC ●.
The tape stands by for recording.
“REC” and “▶” (or “◀”) appear.
- 7** Press DIR MODE on the remote repeatedly to select “◀▶” to record on one side of the tape, or “▶▶” or “◀◀” to record on both sides.

- 8** Press TAPE II.
Recording starts.

To stop recording

Press TAPE ■.

Tips

- To record from a non-preset station, press TUNING MODE repeatedly in step 3 until “AUTO” and “PRESET” disappear, then press TUNING +/- repeatedly to tune in the desired station.
- To record with the Dolby NR system on, press DOLBY NR on the remote before step 8. “DOLBY NR” appears.
- To start recording on the side facing away from you, after doing step 6, press TAPE ◀ until “REC” changes to “◀REC.”
- If you hear static while you are recording an AM radio program, adjust the AM antenna to improve the reception.

Playing a tape

The system can play three types of tapes: Type I (normal), Type II (CrO₂) and Type IV (metal). The system automatically detects the tape type so there is no need to specify it.

To turn on the system, press I/⏻.

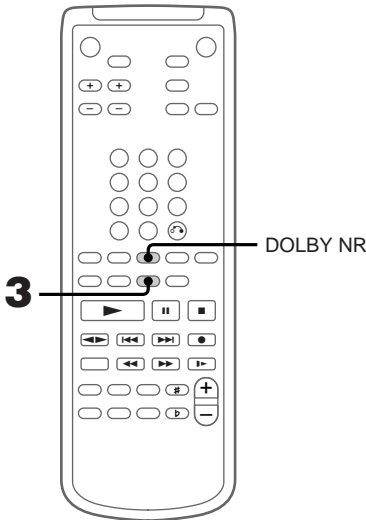
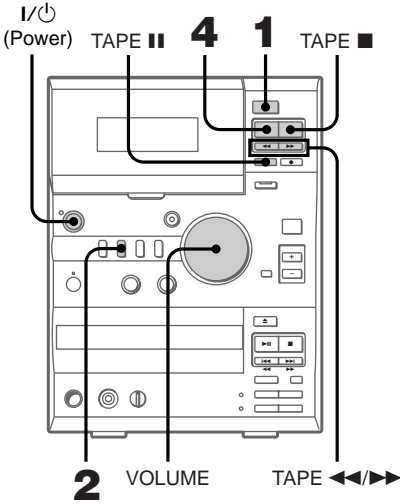

- 1 Press TAPE EJECT ▲ and insert a recorded tape into the cassette holder.

With the side you want to play facing towards you

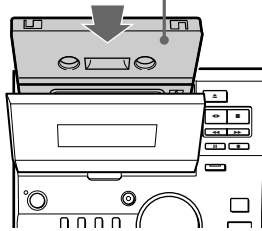

- 2 Press TAPE.
“TAPE” appears.
- 3 Press DIR MODE on the remote repeatedly to select “◀▶” to play one side of the tape, “◀▶▶” to play both sides, or “◀▶▶▶”* to play both sides repeatedly.
* The tape automatically stops after playing back five times.
- 4 Press TAPE ◀▶.
The tape starts playing.
To change the playback direction, press TAPE ◀▶ again. The reverse side will begin playing.

continued

Playing a tape (continued)

To	Do this
Stop playback	Press TAPE ■.
Pause	Press TAPE II. Press again to resume playback.
Fast-forward or rewind	With the tape stopped, press TAPE ►► or TAPE ◀◀.
Remove or replace the tape	Press TAPE EJECT ▲.
Adjust the volume	Turn VOLUME.

Tips

- If you press TAPE ◀▶ when the power is off, the system automatically turns on and starts playing the tape if there is a tape in the holder (One Touch Play).
- To switch to the tape while listening to another source, press TAPE ◀▶ while the tape is stopped. The tape will automatically start playing (Automatic Source Selection).
- To play a tape recorded with the Dolby NR system, press DOLBY NR on the remote before step 4. "□□" appears.

Singing along: Karaoke

Do the procedure below to suppress the singer's voice on any stereo CD/VIDEO CD in order to sing along. To do this, you need to connect an optional microphone.

To turn on the system, press I/⏻.

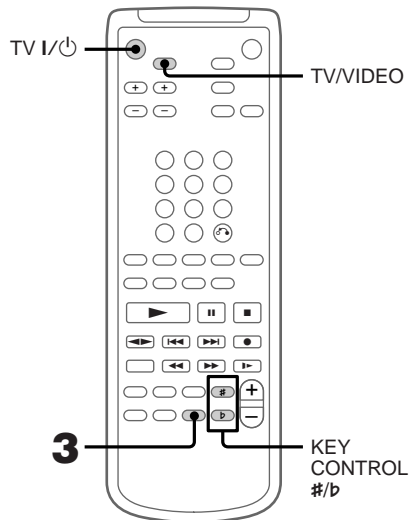
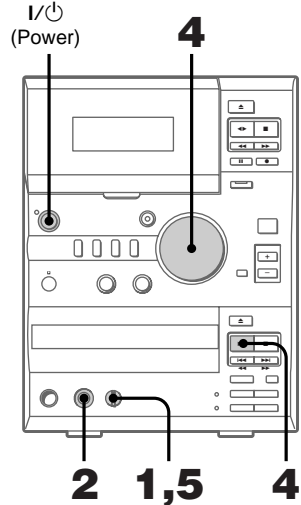

1 Turn MIC VOL to 0 to turn down the microphone volume level.

2 Connect an optional microphone to MIC IN.

3 Press K.PON/MPX on the remote repeatedly to obtain the karaoke effect you want.

Every time you press the button, the display changes as follows:

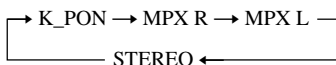

To use the Karaoke function, choose “K_PON” (KARAOKE PON); choose “MPX R” or “MPX L” for multiplexed CDs/VIDEO CDs.

4 Start playing the music and adjust the volume.

5 Adjust the microphone volume by turning MIC VOL.

When using VIDEO CDs

Turn on your TV and switch it to the appropriate video input.

Refer to the operating instructions supplied with your TV for details.

When you are done

Turn MIC VOL to 0 and disconnect the microphone from MIC IN, then press K.PON/MPX on the remote repeatedly so that “STEREO” appears.

Note

With some songs, the volume of vocals may not be suppressed when you select “K_PON”.

Adjusting the key

While singing along with a VIDEO CD or regular audio CD, do the following to adjust the key to suit your vocal range.

➔ Press KEY CONTROL #/b on the remote.

You can adjust the key in 17 steps (b 8 ~ the original key ~ # 8).

Note

This function cannot be used with the tape deck.

Playing a VIDEO CD with PBC functions (Ver. 2.0)

— PBC Play

When you play a VIDEO CD with PBC (Play Back Control) functions, you will be able to use menus on your TV screen to enjoy the disc's interactive software. The menu format and structure will differ with each disc, so be sure to read the instructions supplied with the disc for details.

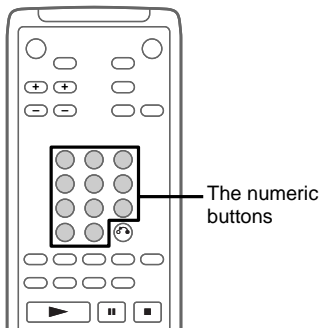
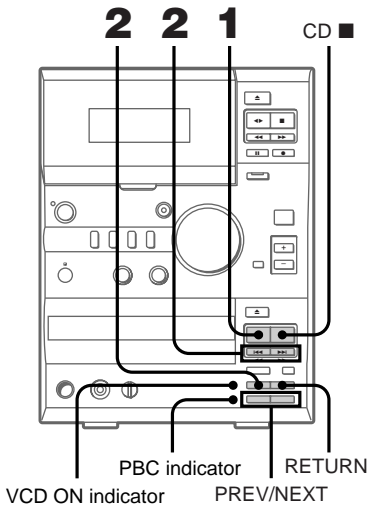

1 Start playing a VIDEO CD with PBC functions (Ver. 2.0).

The VCD ON and PBC indicators light up and a PBC menu appears on your TV.

- VCD ON : Lights up during playback of a VIDEO CD.
- PBC : Lights up during PBC playback of a VIDEO CD with PBC functions (Ver. 2.0). When the PBC functions are not used (see below), PBC goes off.

2 Press CD **◀◀/▶▶** repeatedly to select the number that you want from the menu, then press SELECT.

3 Follow the menu instructions to enjoy interactive playback.

To	Do this
Stop playback	Press CD ■ .
Go to the next scene or track	Press NEXT.
Go back to the preceding scene or track	Press PREV.
Go back to a previous menu	Press RETURN.

To cancel PBC Playback of a VIDEO CD with PBC functions (Ver. 2.0)

There are two ways to cancel the PBC functions.

- Before you start playing, select the track you want using CD **◀◀/▶▶**, then press CD **▶▶**.
- Before you start playing, select the track number using the numeric buttons on the remote.

The PBC indicator goes off and playback begins from the selected track. Still images, such as the menu screens, will not be shown.

Tips

- When  appears on the TV screen, you have pressed an invalid button. Press a button indicated by the instructions on the menu screen.
- When you press NEXT while a menu screen is displayed or while playing moving pictures, the next scene on the disc appears. Refer to the instructions supplied with the disc for more details.

Checking the remaining playing time

Do the procedure below to check the remaining playing time of the current track or the entire CD/VIDEO CD.

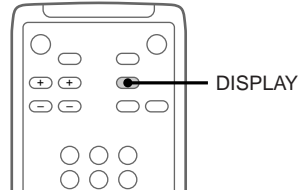

➔ Press DISPLAY.

Each time you press this button, the display changes as follows:

During normal playback

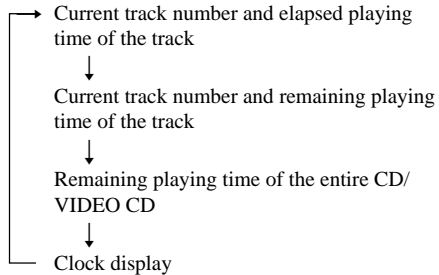

(VIDEO CD with PBC functions
(Ver. 2.0))

Elapsed playing time of the current track*



Clock display

* This may not appear when displaying still images, etc.

continued

Checking the remaining playing time (continued)

In the stop mode

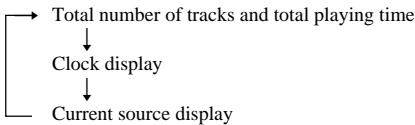

Note

If the CD/VIDEO CD contains 20 tracks or more, the remaining playing time of the current track will appear as “- - -” for each track starting with the 20th.

Using the on-screen display

When a VIDEO CD or audio CD is playing or stopped, you can check the current operating status and disc information of the disc by superimposing a display on top of the TV image.

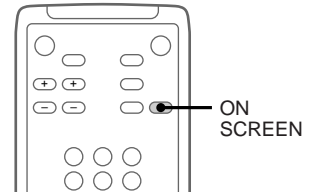

➔ Press ON SCREEN.

Each time you press this button, the on-screen display changes as follows:

ON SCREEN ON



ON SCREEN OFF

ON SCREEN ON display information

- During playback of an audio CD (except during Program Play)

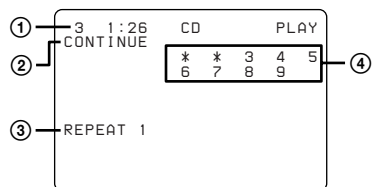

- ① Current track number and elapsed playing time of the track
- ② Play mode
- ③ REPEAT mode or no display
- ④ Music calendar*

* Track numbers disappear from the music calendar after they are played.

• While an audio CD is stopped (except during Program Play)

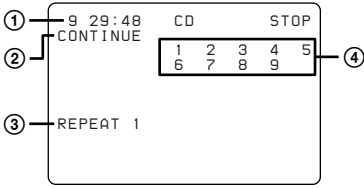

- ① Total number of tracks and total playing time of disc
 - ② Play mode
 - ③ REPEAT mode or no display
 - ④ Music calendar*
- * Track numbers disappear from the music calendar after they are played.

• During playback of a VIDEO CD (except during Program Play)

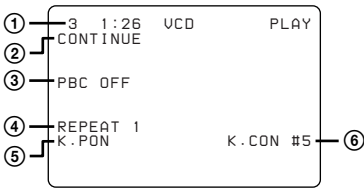

- ① Current track number and elapsed playing time of the track
- ② Play mode
- ③ "PBC OFF"
- ④ REPEAT mode or no display
- ⑤ Karaoke mode or no display
- ⑥ KEY CONTROL (b 8 ~ 0 ~ # 8)

• While a VIDEO CD is stopped (except during Program Play)

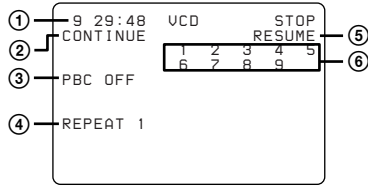

- ① Total number of tracks and total playing time of disc
- ② Play mode
- ③ "PBC OFF"
- ④ REPEAT mode or no display
- ⑤ "RESUME" or no display
- ⑥ Music calendar*

* When the PBC functions are not used, the music calendar appears only while the VIDEO CD is stopped.

• During playback of an audio CD or a VIDEO CD in Program Play

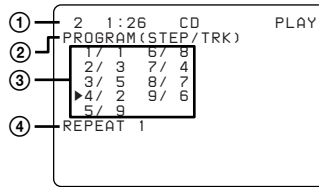

- ① Current track number and elapsed playing time of the track
 - ② Play mode
 - ③ Programmed track numbers*
 - ④ REPEAT mode or no display
- * The selection number and programmed track.

continued

Using the on-screen display (continued)

- While a VIDEO CD or an audio CD is stopped in Program Play

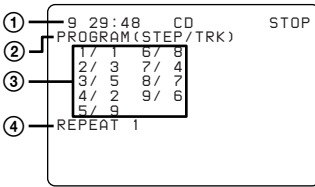

- ① Total number of tracks and total playing time of disc
 - ② Play mode
 - ③ Programmed track numbers*
 - ④ REPEAT mode or no display
- * The selection number and programmed track.

- During playback of a VIDEO CD with PBC functions

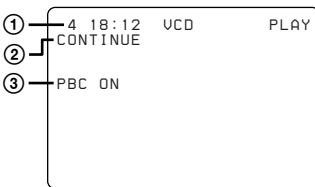

- ① Current track number and elapsed playing time of the track
 - ② Play mode
 - ③ "PBC ON"*
- * "PBC ON" is displayed for a VIDEO CD with PBC functions.

- While a VIDEO CD with PBC functions is stopped

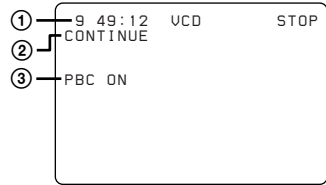

- ① Total number of tracks and total playing time of disc
 - ② Play mode
 - ③ "PBC ON"*
- * "PBC ON" is displayed for a VIDEO CD with PBC functions.

ON SCREEN OFF

No display.

Notes

- Normally, select the display mode set to ON SCREEN ON. When you select ON SCREEN OFF, you cannot check the operating status on the TV screen while operating the system. In this case, check the information on the front panel display.
- When you record video signals played back from the system onto a video tape (etc.), be sure to select ON SCREEN OFF. Otherwise, the display information will also be recorded on the video tape.

Resuming VIDEO CD playback from the point last stopped at

— Resume Play

When you stop VIDEO CD playback, the system memorizes the stopping point so that you can resume playback from that point. Resume Play is not cancelled when you turn off the system.

Note that this function cannot be used when playing an audio CD.

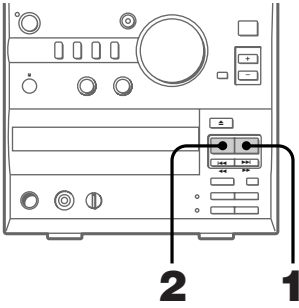

Notes

- Resume Play is not available in Shuffle or Program Play, or during PBC playback of a VIDEO CD with PBC functions (Ver. 2.0).
- Depending on where you stopped the VIDEO CD, the system may resume playback from a different point.
- The point at which you stopped playback is cleared when:
 - you press a numeric button on the remote, PLAY MODE, or CD ■.
 - you remove the VIDEO CD.
 - you disconnect the power cord.

1 While playing a VIDEO CD, press CD ■ to stop playback. “RESUME” appears on your TV screen. If “RESUME” does not appear, Resume Play is not available.

2 Press CD ►||. Playback starts from the point you stopped the VIDEO CD in step 1.

To view from the beginning of the VIDEO CD

When “RESUME” appears in the display, press CD ■, then press CD ►||.

Playing CD/VIDEO CD tracks repeatedly

— Repeat Play

The Repeat Play function lets you playback a single track or all the tracks on a CD/VIDEO CD repeatedly in Normal Play. You can also use Repeat Play function while in Shuffle Play or Program Play. The PBC functions of VIDEO CD (Ver. 2.0) are disabled during Repeat Play.

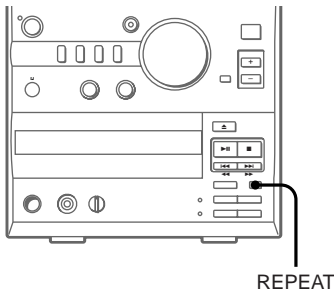

➔ Press REPEAT repeatedly during playback until “REPEAT” appears. Repeat Play starts. The following table describes the two repeat modes.

To repeat	Press
All the tracks on the CD/VIDEO CD	REPEAT repeatedly until “REPEAT” appears.
Only the currently playing track	REPEAT repeatedly until “REPEAT 1” appears.

To cancel Repeat Play

Press REPEAT repeatedly until “REPEAT” and “REPEAT 1” disappear.

Playing CD/VIDEO CD tracks in random order

— Shuffle Play

You can use this function to playback all the tracks on a CD/VIDEO CD in random order. The PBC functions of VIDEO CD (Ver. 2.0) are disabled during Shuffle Play.

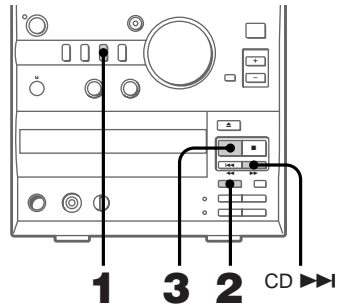

- 1** Press CD.
“CD” appears.
- 2** Press PLAY MODE repeatedly until “SHUFFLE” appears.
- 3** Press CD ►►.
Shuffle Play starts. “◻” appears while the next track is being selected, and all the tracks play in random order.

To cancel Shuffle Play

Press PLAY MODE repeatedly until “SHUFFLE” disappears.

Tips

- You can also start Shuffle Play during Normal Play by selecting “SHUFFLE”.
- To skip a track, press CD ►►.

Note

You cannot go back to the preceding track by pressing CD ◀◀.

Playing CD/VIDEO CD tracks in a favorite order — Program Play

You can make a program of up to 20 tracks on a CD/VIDEO CD in any order that you want. After setting the order, you can also make a synchronized tape recording of the tracks (see page 31). The PBC functions of VIDEO CD (Ver. 2.0) are disabled during Program Play.

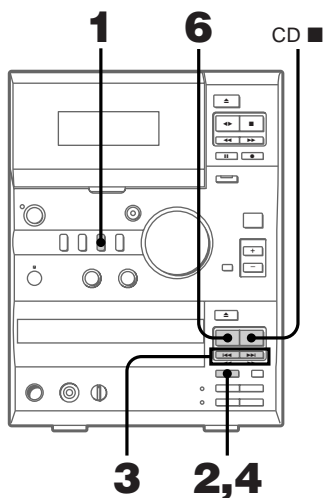

1 Press CD.
“CD” appears.

2 Press PLAY MODE repeatedly until “PGM” appears.

3 Press CD ◀◀ or CD ▶▶ repeatedly until the desired track number appears.

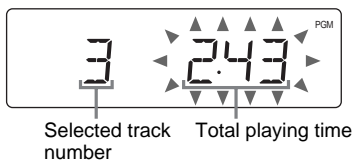

4 Press PLAY MODE.
The selected track is programmed. “STEP” appears, followed by the number of the selection just programmed.

5 To program additional tracks, repeat steps 3 and 4.

6 Press CD ▶▶.
Program Play starts. The tracks play in the order that they were programmed.

To cancel Program Play

Press PLAY MODE repeatedly until “PGM” disappears.

To	Do this
Add a track to the end of the program	Do steps 3 and 4 with Program Play stopped.
Erase the entire program	Press CD ■ with Program Play stopped.

Tips

- The program you made remains in the system’s memory until you turn off the system or remove the disc. After the program finishes, press CD ▶▶ to play the program again.
- When the total playing time of the programmed tracks exceeds 100 minutes, “- . - . -” appears in the display.
- If you try to program more than 20 tracks, “PGM FULL” appears in the display.

Recording to a tape manually

Do the procedure below to manually record from any source to a tape. For example, tracks from a CD, the radio, or from any of the connected components. This lets you record just the songs that you want from a CD/VIDEO CD.

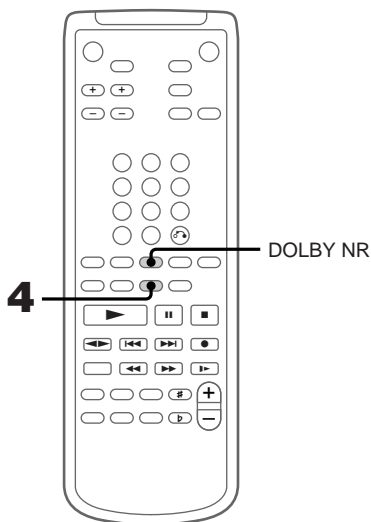
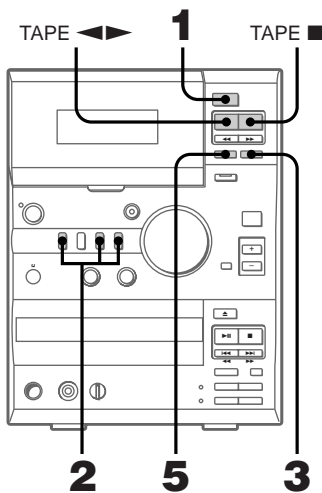

- 1** Press TAPE EJECT and insert a recordable tape.
- 2** Press the button of the source you want to record from.
 - CD: To record from the CD/VIDEO CD
 - TUNER: To record from the radio
 - MD/VIDEO: To record from optional component
- 3** Press REC . The tape stands by for recording. "REC" and "▶" (or "◀") appear.
- 4** Press DIR MODE on the remote repeatedly to select "↔" to record on one side of the tape, or "↔↔" or "↔↔" to record on both sides.
- 5** Press TAPE II. Recording starts.
- 6** Start playing the source you want to record from.

To	Press
Stop recording	TAPE II.
Pause recording	TAPE II.

Tips

- To record with the Dolby NR system on, press DOLBY NR on the remote before step 5. "NR" appears.
- To start recording on the side facing away from you, after doing step 3, press TAPE until "REC" changes to "◀REC."

Recording your favorite CD/VIDEO CD tracks to a tape — *Program Edit*

With Program Edit function, you can select only the CD/VIDEO CD tracks that you want using the Program Play function, then record the programmed tracks to a tape using the CD Synchro Recording function. The PBC functions of VIDEO CD (Ver. 2.0) are disabled during Program Play.

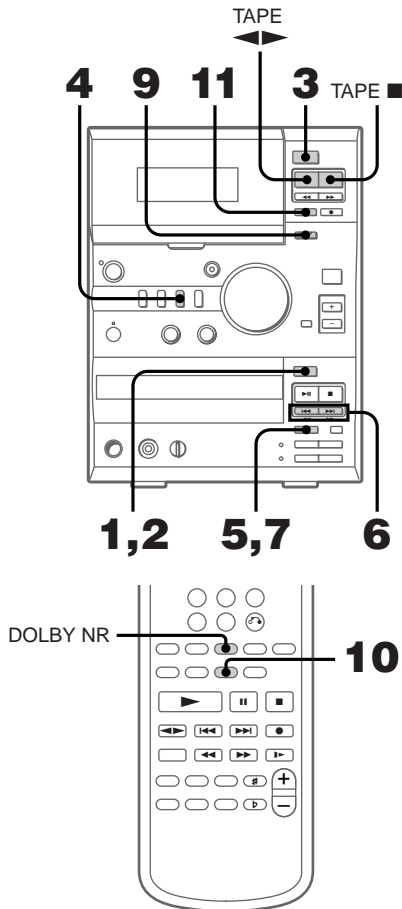

- 1** Press CD EJECT ▲ and place a disc.
- 2** Press CD EJECT ▲ again to close the disc tray.
- 3** Press TAPE EJECT ▲ and insert a recordable tape.
- 4** Press CD.
“CD” appears.
- 5** Press PLAY MODE repeatedly until “PGM” appears.

- 6** Press CD ◀◀ or CD ▶▶ repeatedly until the desired track number appears.

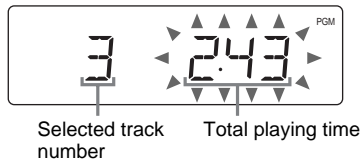

- 7** Press PLAY MODE.
- 8** Repeat steps 6 and 7 to add more tracks to be recorded.

continued

Recording your favorite CD/ VIDEO CD tracks to a tape (continued)

9 Press CD SYNC.

The tape stands by for recording and the VIDEO CD/CD stands by for playback.

“**REC**” and “▶” (or “◀”) appear, and the CD SYNC indicator lights up.

10 Press DIR MODE on the remote repeatedly to select “↔” to record on one side of the tape, or “↔” or “↔” to record on both sides.

11 Press TAPE ■

Recording starts.

To stop recording

Press TAPE ■.

To cancel Program Edit

Press PLAY MODE repeatedly until “PGM” disappears.

Tips

- To record with the Dolby NR system on, press DOLBY NR on the remote before step 11. “**□□**” appears.
- To start recording on the side facing away from you, after doing step 9, press TAPE ◀▶ until “**REC▶**” changes to “◀**REC**.”

Waking up to music

— Daily Timer

By setting the Daily Timer, you can make the system automatically turn on and off at specified times. To use this function, make sure that you have set the system clock correctly (see “Step 2: Setting the time” on page 7).

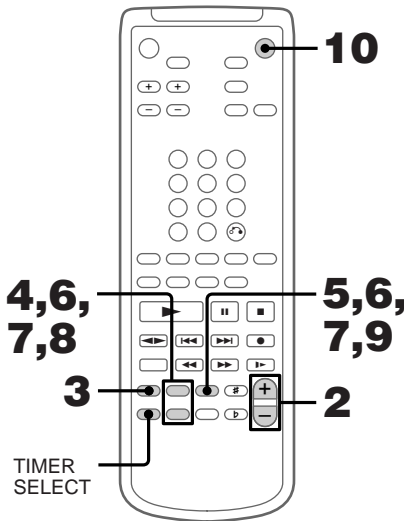

- 1 Prepare the music source you want to listen to when the system turns on.
 - CD/VIDEO CD: Place a disc. To start playing from a specific track, make a program (see “Playing CD/VIDEO CD tracks in a favorite order” on page 29).
 - Tape: Insert a tape with the side you want to play facing towards you.
 - Radio: Tune in the preset radio station that you want (see “Listening to the radio” on page 16).

- 2 Press VOL +/- repeatedly to adjust the volume.
- 3 Press TIMER SET.
- 4 Press +/- repeatedly until “SET DAILY” appears. “SET DAILY” scrolls and “⊖ DAILY” appears in the display.

- 5 Press ENTER. “ON TIME” appears, then the hour indication flashes.



- 6 Set the starting time. Press +/- repeatedly to set the hour, then press ENTER. The minute indication begins flashing next.



- Press +/- repeatedly to set the minute, then press ENTER. “OFF TIME” appears, then the hour indication flashes again.

- 7 Set the stopping time by repeating step 6.
- 8 Press +/- repeatedly until the music source you want appears. Each time you press the button, the display changes as follows:

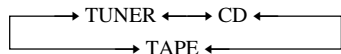

9 Press ENTER.

The starting time, the stopping time, and the music source appear in turn, then the original display returns.

10 Press I/⏻ to turn off the system.

To check the settings

Press TIMER SELECT repeatedly until “⌚ DAILY” appears in the display.

The preset items appear in turn.

To turn off the Daily Timer

Press TIMER SELECT repeatedly until “⌚ DAILY” disappears. To turn the timer on again, press TIMER SELECT repeatedly until “⌚ DAILY” appears, then press I/⏻ to turn off the system.

Tip

Once you set the Daily Timer, the time settings will remain in the system’s memory until you change them, even when you turn the system or the Daily Timer off. The settings that were last used will be in effect when you turn the timer on again.

Notes

- The system will turn on 15 seconds before the specified starting time.
- The timer will not operate if the starting time and the stopping time are the same.
- When you have set the Sleep Timer, the Daily Timer will not operate until the Sleep Timer function is turned off.
- You cannot operate the Daily Timer and the REC Timer (see this page) at the same time.

Timer-activated recording of radio programs — REC Timer

Set the REC Timer to make the system start recording from a preset radio station at a specified time (see “Step 3: Presetting radio stations” on page 8). To use this function, make sure that you have set the system clock correctly (see “Step 2: Setting the time” on page 7).

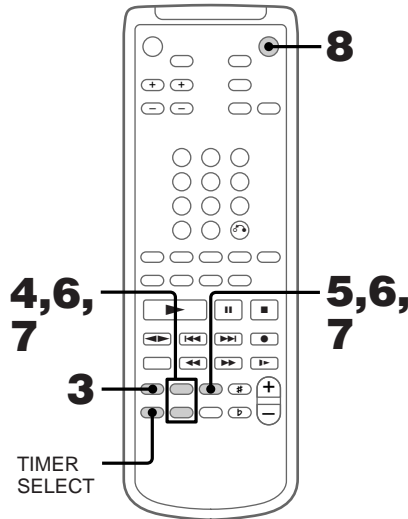

1 Tune in the preset radio station that you want to record from (see “Listening to the radio” on page 16).

2 Insert a recordable tape with the side you want to record on facing towards you.

3 Press TIMER SET.

continued

Timer-activated recording of radio programs (continued)

- 4** Press +/- repeatedly until “SET REC” appears.
“SET REC” scrolls and “⊖ REC” appears in the display.

- 5** Press ENTER.
“ON TIME” appears, then the hour indication flashes.



- 6** Set the starting time.
Press +/- repeatedly to set the hour, then press ENTER.
The minute indication begins flashing next.



Press +/- repeatedly to set the minute, then press ENTER.
“OFF TIME” appears, then the hour indication flashes again.

- 7** Set the stopping time by repeating step 6.
The starting time, the stopping time, “TUNER”, and the preset station appear in turn, then the original display returns.

- 8** Press I/⏻ to turn off the system.
When recording starts, the volume level is automatically set to the minimum.

To check the settings

Press TIMER SELECT repeatedly until “⊖ REC” appears in the display.

The preset items appear in turn.

To turn off the REC Timer

Press TIMER SELECT repeatedly until “⊖ REC” disappears. To turn the timer on again, press TIMER SELECT repeatedly until “⊖ REC” appears, then press I/⏻ to turn off the system.

Tip

Once you set the REC Timer, the time settings will remain in the system’s memory until you change them, even when you turn the system or the REC Timer off. The settings that were last used will be in effect when you turn the timer on again.

Notes

- The system will turn on 15 seconds before the specified starting time.
- If the power is on at the specified starting time, recording will not occur.
- The timer will not operate if the starting time and the stopping time are the same.
- When you have set the Sleep Timer, the REC Timer will not operate until the Sleep Timer function is turned off.
- You cannot operate the Daily Timer and the REC Timer at the same time.

Precautions

On operating voltage

Before operating the system, check that the operating voltage of your system is identical with the voltage of your local power supply.

On safety

- The unit is not disconnected from the AC power source (mains) as long as it is connected to the wall outlet, even if the unit itself has been turned off.
- Unplug the system from the wall outlet (mains) if it will not be used for an extended period of time. To disconnect the power cord (mains lead), pull it out by the plug. Never pull the cord itself.
- Should any solid object or liquid fall into the system, unplug the system and have it checked by qualified personnel before operating it any further.
- AC power cord must be changed only at the qualified service shop.

On placement

- Place the system in a location with adequate ventilation to prevent heat build-up in the system.
- Do not place the system in an inclined position.
- Do not place the system in locations where it is:
 - Extremely hot or cold
 - Dusty or dirty
 - Very humid
 - Subject to vibrations
 - Subject to direct sunlight

On operation

- If the system is brought directly from a cold place to a warm place, or is placed in a very damp room, moisture may condense on the lens inside the VIDEO CD/CD player. Should this occur, the system will not operate properly. Remove the disc and leave the system turned on for about an hour until the moisture evaporates.
- When moving the unit, remove any disc that may be on the disc tray.

If you have any questions or problems concerning your system, please consult your nearest Sony dealer.

Notes on CDs/VIDEO CDs

- Before playing a CD/VIDEO CD, clean the disc surface with a cleaning cloth. Wipe the disc from the center out.
- Do not play a disc with tape, stickers, or adhesives on any of its surfaces as this may damage the system.
- Do not clean discs with solvents such as benzene, thinner, commercially available cleaners or antistatic sprays intended for vinyl LPs.
- Do not expose discs to direct sunlight or heat sources such as hot air ducts, or leave them in a car parked in direct sunlight.

To save a tape permanently

To prevent a tape from being accidentally recorded over, break off the cassette tabs from side A or side B as illustrated.

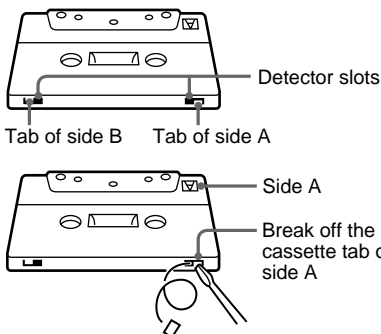

If you later want to reuse the tape for recording, cover the broken tab with adhesive tape. However, be careful not to cover the detector slots which allow the tape player to automatically detect the type of tape.

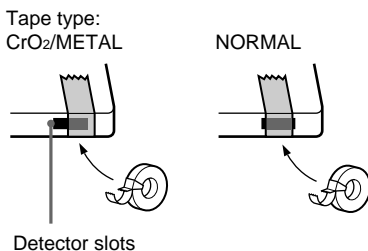

Before placing a cassette in the tape deck

Take up any slack in the tape. Otherwise the tape may get entangled in the tape deck's playing mechanism and become damaged.

continued

Precautions (continued)

When using a tape longer than 90 minutes

The tape is very elastic. Do not change the tape operations such as play, stop, and fast-winding etc. too frequently. The tape may get entangled in the tape deck's playing mechanism.

Cleaning the tape heads

Clean the tape heads after every 10 hours of use.

When the tape heads become dirty

- the sound becomes distorted
- the sound level decreases
- the sound drops out
- the tape does not erase completely
- the tape does not record

Make sure to clean the tape heads before making an important recording or after playing an old tape. Use a commercially available dry-type or wet-type cleaning cassette. For details, refer to the instructions of the cleaning cassette.

Demagnetizing the tape heads

Demagnetize the tape heads and the metal parts that have contact with the tape after every 20 to 30 hours of use with a commercially available demagnetizing cassette. For details, refer to the instructions of the demagnetizing cassette.

In case color irregularity is observed on nearby a TV screen

With the magnetically shielded type of speaker system, the speakers can be installed near a TV set. However, color irregularity may still be observed on the TV screen depending on the type of your TV set.

If color irregularity is observed...

Turn off the TV set once, then turn it on after 15 to 30 minutes.

If color irregularity is observed again...

Place the speakers farther away from the TV set.

Cleaning the cabinet

Clean the cabinet, panel and controls with a soft cloth slightly moistened with mild detergent solution. Do not use any type of abrasive pad, scouring powder or solvent such as thinner, benzene or alcohol.

Troubleshooting

Should you encounter a problem with your system, do the following:

- 1** Make sure the power cord and speaker cords are correctly and firmly connected.
- 2** Find your problem in the troubleshooting checklist below and take the indicated corrective action.

If the problem persists after doing all of the above, consult your nearest Sony dealer.

General

There is no sound from the speakers.

- Adjust VOLUME.
- The headphones are connected.
- Check the speaker connections.

There is severe hum or noise.

- A TV or VCR is placed too close to the system. Move the system away from the TV or VCR.

"AM 12:00" flashes in the display.

- A power interruption has occurred. Set the clock (see page 7) and timer settings (see pages 34 and 35) again.

The timer does not function.

- Make sure the clock is correctly set (see page 7).

"⌚ DAILY" and "⌚ REC" do not appear when you press TIMER SELECT on the remote.

- Make sure each timer is correctly set (see pages 34 and 35).
- Make sure the clock is correctly set (see page 7).

The color on the TV screen is irregular.

- Move the speakers farther away from the TV set.
-

The remote does not work.

- There is an obstacle between the remote and the unit.
 - You are not pointing the remote in the direction of the system's sensor.
 - The batteries in the remote have run down. Replace the batteries.
 - Make sure that the batteries are inserted correctly.
-

Speakers

Sound comes from only one channel, or the left and right volumes are unbalanced.

- Check the speaker connections and placement.
-

VIDEO CD/CD Player

There is no picture.

- Check that the system is connected securely.
 - Make sure that you have operated the TV correctly.
 - Make sure that you have set the SYSTEM SELECT to proper setting for the color system of your TV.
 - Press CD to switch to the VIDEO CD/CD function.
-

The VIDEO CD/CD will not play.

- The disc is dirty.
 - The surface of the disc is scratched. Replace the disc.
 - The disc is inserted with the label side down.
 - Condensation has built up in the system. Remove the disc and leave the system turned on for about an hour until the moisture evaporates.
-

Play does not start from the first track.

- The player is in Program or Shuffle Play. Press PLAY MODE repeatedly until "PGM" and "SHUFFLE" disappear.
-

Tape Deck

Recording cannot be done.

- There is no tape in the cassette holder.
 - The record protect tab has been removed from the cassette (see page 37).
 - The tape has come to the end.
-

The tape does not record or play, or there is a decrease in sound level.

- The heads are dirty. Clean them (see page 38).
 - The record/playback heads are magnetized. Demagnetize them (see page 38).
-

The tape does not erase completely.

- The record/playback heads are magnetized. Demagnetize them (see page 38).
-

There is excessive wow or flutter, or the sound drops out.

- The capstans or pinch rollers are dirty. Clean them (see page 38).
-

Noise increases or the high frequencies are missing.

- The record/playback heads are magnetized. Demagnetize them (see page 38).
-

continued

Troubleshooting (continued)

Tuner

There is a severe hum or noise (“TUNED” or “STEREO” flashes).

- Adjust the antenna.
- The signal strength is too weak. Connect an external antenna (see page 11).
- Make sure that the antenna is connected properly.
- Do not bend or roll up the antenna.
- The two wires comprising the FM antenna have been pulled further apart since the system was first purchased. Repair or replace with a new one.
- The AM antenna wire is detached from the stand.

A stereo FM program cannot be received in stereo.

- Press STEREO/MONO on the remote until “STEREO” appears in the display.

Resetting the system

- 1 Disconnect the power cord from the wall outlet.
- 2 Press I/\cup down and connect the power cord to the wall outlet again.

The system is reset to the factory settings. All previous settings such as the preset stations, clock, and timers are cleared and must be set again.

Specifications

Amplifier section

The following measured at 230 V AC, 60 Hz

DIN power output (rated): 30 + 30 W
(6 ohms at 1 kHz, DIN)

Continuous RMS power output (reference):
35 + 35 W
(6 ohms at 1 kHz, 10% THD)

The following measured at 220 V AC, 60 Hz

DIN power output (rated): 24 + 24 W
(6 ohms at 1 kHz, DIN)

Continuous RMS power output (reference):
27 + 27 W
(6 ohms at 1 kHz, 10% THD)

Inputs

MD IN (phono jacks): Sensitivity 500 mV, impedance
47 kilohms

VIDEO IN (phono jacks): Sensitivity 250 mV, impedance
47 kilohms

MIC (mini jack): sensitivity 1 mV,
impedance 10 kilohms

Outputs

LINE OUT (phono jacks): Sensitivity 250 mV, impedance
1 kilohm

OPTICAL DIGITAL OUT (CD):
Optical

VIDEO OUT (phono jack):
max. output level 1 V_{p-p},
unbalanced, Sync negative, load
impedance 75 ohms

PHONES (stereo phone jack):
Accepts headphones with an
impedance of 8 ohms or more

VIDEO CD/CD player section

System Compact disc and digital audio and
video system

Laser Semiconductor laser
($\lambda=780$ nm)

Laser output Emission duration: continuous
MAX 44.6 μ W*

* This output is the value
measured at a distance of
200 mm from the objective
lens surface on the optical
pick-up block with 7 mm
aperture.

Wavelength 780 - 790 nm

Video color system format
NTSC, PAL

OPTICAL DIGITAL OUT (CD)

(Square optical connector jack, rear panel)

Wavelength 660 nm

Output Level -18 dBm

Tape player section

Recording system	4-track 2-channel stereo
Frequency response (DOLBY NR OFF)	50 - 13,000 Hz (± 3 dB), using a Sony TYPE I cassette 50 - 14,000 Hz (± 3 dB), using a Sony TYPE II cassette
Wow and flutter	$\pm 0.15\%$ W. Peak (IEC) 0.1% W. RMS (NAB) $\pm 0.2\%$ W. Peak (DIN)

Tuner section

FM stereo, FM/AM superheterodyne tuner

FM tuner section

Tuning range	87.5 - 108.0 MHz (50-kHz step)
Antenna	FM wire antenna
Antenna terminals	75 ohm unbalanced
Intermediate frequency	10.7 MHz

AM tuner section

Tuning range	
Middle Eastern model:	531 - 1,602 kHz (with the tuning interval set at 9 kHz)
Other models:	530 - 1,710 kHz (with the tuning interval set at 10 kHz) 531 - 1,602 kHz (with the tuning interval set at 9 kHz)
Antenna	AM loop antenna, external antenna terminal
Intermediate frequency	450 kHz

Speakers

Speaker system	Two-way, bass reflex system, magnetically shielded type
Speaker units	12 cm dia., cone type woofer 2.5 cm dia., semi-dome-type tweeter
Rated impedance	6 ohms
Dimensions (w/h/d)	Approx. 150 \times 252 \times 255 mm
Mass	Approx. 2.9 kg net per speaker

General

Power requirements	110 - 120 V or 220 - 240 V AC , 50/60 Hz Adjustable with voltage selector
Power consumption	75 W
Dimensions (w/h/d)	Approx. 190 \times 252 \times 330 mm incl. projecting parts and controls
Mass	Approx. 5.7 kg
Supplied accessories	Remote commander (1) AM loop antenna (1) FM wire antenna (1) Batteries (2) Video connecting cord (1)

Design and specifications are subject to change without notice.

Glossary

Auto Pause

An automatically pauses according to the signal encoded on the disc while playing a VIDEO CD. If the VIDEO CD/CD player does not resume play for a long time, press CD ►|| to resume play manually.

Menu Playback

Playback using the menu screens recorded on VIDEO CDs with PBC functions. You can enjoy simple interactive software using the menu playback function.

Playback Control (PBC)

Signals encoded on VIDEO CDs (Version 2.0) to control playback.

By using menu screens recorded on VIDEO CDs with PBC functions, you can enjoy playing simple interactive software, software with search functions, and so on.

When you select a VIDEO CD with PBC functions on this system, the PBC indicator lights up.

Track

Sections of a picture or a music piece on disc. Each track is assigned with a track number to help you locate the track you want.

VIDEO CD

A compact disc which contains moving pictures. VIDEO CDs contain compact picture information using the MPEG 1 format, one of the world wide standards of digital compact technology. The picture information is compressed about 120 times. Consequently, a 12 cm VIDEO CD can contain up to 74 minutes of moving pictures. VIDEO CDs also contain compact audio information. Sounds outside the range of human hearing are compressed while the sounds we can hear are not compressed. VIDEO CDs can hold six times the audio information of conventional audio CDs.

There are two versions for VIDEO CDs: Version 1.1 (VIDEO CDs without PBC functions):

You can play only moving pictures and sounds.

Version 2.0 (VIDEO CDs with PBC functions):

You can play still pictures and enjoy PBC functions.

This system conforms to both versions.

Parts identification for the remote

You can also operate the system with the supplied remote.

Buttons marked with “*” are provided only on the remote.

TUNER

Remote Button(s)	Function
TUNER BAND	Selects FM or AM.
TUNING MODE	Selects “AUTO”, “PRESET” or “MANUAL”.
MEMORY*	Presets a station.
STEREO/MONO*	Selects “STEREO” or “MONO”.
◀◀/▶▶	Scans for a station or selects a preset station.

VIDEO CD/CD

Remote Button(s)	For operating the	Function
SELECT/CD ►	VIDEO CD/CD	Starts playback.
■	VIDEO CD/CD	During playback of a VIDEO CD with PBC functions (Ver. 2.0), you can use this button to specify a menu item.
	VIDEO CD/CD	Stops playback.
	VIDEO CD/CD	Pauses playback.
◀◀/▶▶	VIDEO CD/CD	Selects a track (AMS: Automatic Music Sensor).
◀◀/▶▶	VIDEO CD/CD	Locates a desired point in a track.
RETURN ↶	VIDEO CD	Go back to a previous menu.

Remote Button(s)	For operating the	Function
Numeric buttons*	VIDEO CD	Selects a number from the menu during playback of a VIDEO CD with PBC functions (Ver. 2.0). To enter numbers over 10, first press >10, then press the numeric buttons. To enter 0, use the 10/0 button.
SLOW ▶▶*	VIDEO CD	Slows playback.
ON SCREEN*	VIDEO CD/CD	Shows display information.
K.PON/MPX*	VIDEO CD/CD	Obtains the karaoke effect.
KEY CONTROL*	VIDEO CD/CD	Adjusts the key.
REPEAT	VIDEO CD/CD	Repeats playback.
PLAY MODE	VIDEO CD/CD	Selects Shuffle, Program or Normal Play.
DISPLAY*	VIDEO CD/CD	Changes the front panel display.

TAPE

Remote Button(s)	Function
TAPE ◀▶	Starts playback. Each time you press this button, the tape reverses direction.
■	Stops playback.
	Pauses playback.
◀◀/▶▶	Fast-forwards or rewinds.
●	Records to tapes.
DIR MODE*	Selects “◀→”, “↔” or “↺↻”.
DOLBY NR*	Turns on or off the Dolby NR system.

TIMER

Remote Button	Function
SLEEP*	Selects a sleep time.
TIMER SET*	Sets the time, Daily Timer or REC Timer.
TIMER SELECT*	Checks the settings and turns on or off the timer.

OTHERS

Remote Button(s)	For operating the	Function
I/⏻	Amplifier	Turns on or off the system.
VOL +/-	Amplifier	Adjusts the volume.
DSG	Amplifier	Generates a more dynamic sound.
MD	Amplifier	Selects an optional MD deck as the audio source.
VIDEO	Amplifier	Selects an optional VCR as the audio source.

TV

See page 6.

Index

A

Adjusting

- the bass 33
- the treble 33
- the volume 13, 14, 16, 20

Antennas 4, 11

Automatic Source Selection 13,
14, 17, 20

B

Batteries 6

C

Clock setting 7

Connecting. *See* Hooking up

D, E, F, G

Daily Timer 34

H, I, J

Hooking up

- optional components 9
- the antenna 4, 11
- the power cord 5
- the system 4

K, L, M

Karaoke

- adjusting the key 21
- singing along with a
multiplexed CD/VIDEO
CD (MPX R/MPX L) 21
- suppressing the vocals
(KARAOKE PON) 21

N

Normal Play 13

O

One Touch Play 13, 14, 17, 20
On-screen display 24

P, Q

PBC functions 22, 42

PBC Play 22

Playing

- a CD 13
- a tape 19
- a VIDEO CD 12
- tracks in random order
(Shuffle Play) 28
- tracks in the desired order
(Program Play) 29
- tracks repeatedly (Repeat
Play) 28

Presetting radio stations 8

Preset Tuning 16

Program Edit 31

Program Play 29

Protecting recordings 37

R

Radio stations

- presetting 8
- tuning in 16

Recording

- a CD/VIDEO CD 14
- a radio program 17
- a tape manually 30
- CDs/VIDEO CDs by
specifying the track order
31
- timer-activated recording
35

Repeat Play 28

Resetting the system 40

S

Selecting the color system 5

Setting the time 7

Shuffle Play 28

Sleep Timer 33

Slowing playback 13

Speakers 4

T

Tape deck 14, 17, 19, 30, 35

Timer

- falling asleep to music 33
- timer-activated recording
35
- waking up to music 34

Troubleshooting 38

Tuner 8, 16, 17, 35

U

Using the display 23

Using the DSG 33

V, W, X, Y, Z

VIDEO CD/CD player 2,
12-15, 20, 22, 31