

Mini Hi-Fi Component System

Operating Instructions



DHC-MD373

Do not install the appliance in a confined space, such as a bookcase or built-in cabinet.



This appliance is classified as a CLASS 1 LASER product. The CLASS 1 LASER PRODUCT MARKING is located on the rear exterior.

The following caution label is located inside of the unit.



Table of Contents

Getting Started

Step 1: Hooking up the system	4
Step 2: Setting the time	6
Step 3: Presetting radio stations	7
Saving the power in standby mode	9

Basic Operations

Playing a CD	10
Recording a CD on an MD	
— CD-MD Synchro Recording	11
Playing an MD	12
Listening to the radio	
— Preset Tuning	13
Recording from the radio	
— Manual Recording	14

The CD Player

Playing CD tracks repeatedly	
— Repeat Play	16
Playing CD tracks in random order	
— Shuffle Play	16
Programming CD tracks	
— Programme Play	17
Using the CD display	18
Labelling a CD — Disc Memo	19

The MD Deck — Play

Playing MD tracks repeatedly	
— Repeat Play	21
Playing MD tracks in random order	
— Shuffle Play	22
Programming MD tracks	
— Programme Play	22
Using the MD display	24

The MD Deck — Recording

Before you start recording	25
Recording your favourite CD tracks on an MD	
— CD-MD Synchro Recording	26
Recording on an MD manually	
— Manual Recording	27
Starting recording with 6 seconds of prestored audio data	
— Time Machine Recording	28
Marking track numbers	30
Making a space between tracks	
3 seconds long — Smart Space	31
Adjusting the recording level	33
Monaural recording	34

The MD Deck — Editing

Before you start editing	35
Labelling an MD — Name Function	36
Erasing recordings — Erase Function	37
Moving recorded tracks	
— Move Function	40
Dividing recorded tracks	
— Divide Function	41
Combining recorded tracks	
— Combine Function	42
Undoing the last edit	
— Undo Function	44

Sound Adjustment

Reinforcing the bass sound — DBFB	45
Selecting the Preset Equalizer menu	45

Other Features

Labelling the preset stations	
— Station Name	46
Using the Radio Data System (RDS) (European model only)	47
Falling asleep to music	
— Sleep Timer	48
Waking up to music	
— Daily Timer	48
Timer recording radio programmes	50

Connecting optional components

Connecting optional A/V components	52
Connecting external aerials	53

Additional Information

Precautions	54
System limitations of MDs	55
Troubleshooting	56
Self-diagnosis Display	58
Specifications	60
Parts descriptions for the remote	61
Index	63

Step 1: Hooking up the system

Perform the following procedure **1** to **4** to hook up your system using the supplied cords and accessories.

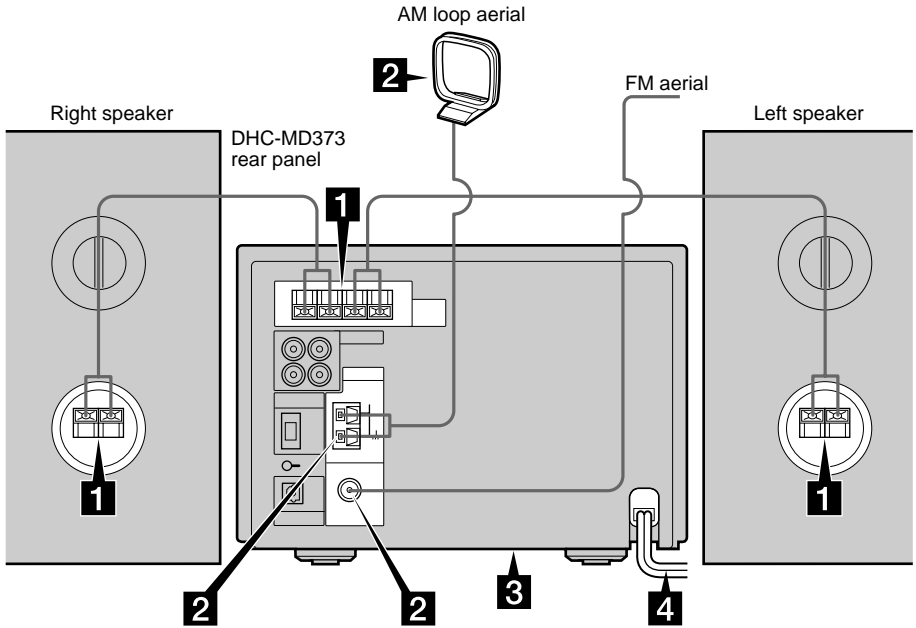

1 Connect the speakers.

Connect the speaker cords to the **SPEAKER** terminals on the unit and to the terminals on the speakers as below.

Keep the speaker cords away from the aerials to prevent noise.

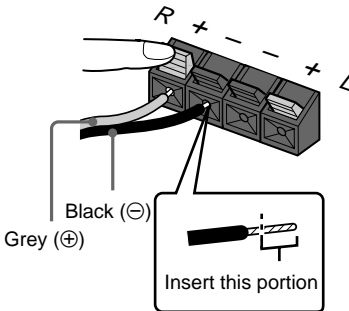

2 Connect the FM/AM aerials.

Set up the AM loop aerial, then connect it.

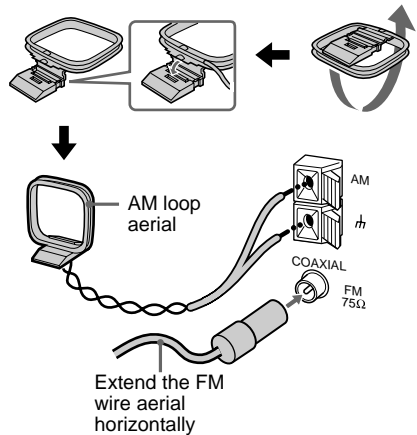

-
- 3** Set the VOLTAGE SELECTOR on the bottom of the system to the position of your local power line voltage (for models with a voltage selector).

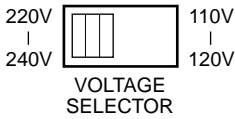

-
- 4** Connect the mains lead to a wall outlet. If the plug of the mains lead does not fit your wall outlet, attach the supplied adaptor on to the plug (for models with a plug adaptor).
-

Inserting two R6 (size AA) batteries into the remote

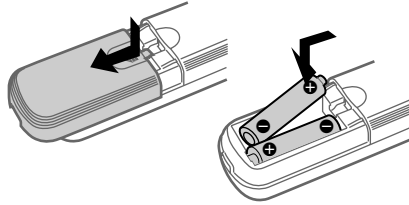

Tip

With normal use, the batteries should last for about six months. When the remote no longer operates the system, replace both batteries with new ones.

Notes

- If you do not use the remote for a long period of time, remove the batteries to avoid possible damage from battery leakage.
- Be sure to insert the batteries in correct direction.
- Do not mix new batteries with old ones.
- Do not use different types of batteries together.
- Do not use a battery that is leaking.
- If the battery leaks, clean the battery compartment and replace all the batteries with new ones.

Step 2: Setting the time

You must set the time beforehand to use the timer functions.

The clock is on a 24-hour system for the European model, and a 12-hour system for other models.

The 24-hour system is used for illustration purposes.

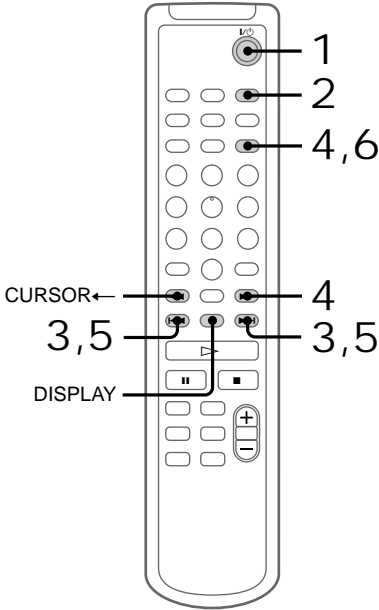

1 Turn on the system.

2 Press **CLOCK/TIMER SET**.
The clock appears and the hour indication flashes.

3 Press **◀** or **▶** to set the hour.

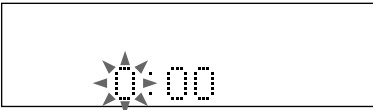

4 Press **ENTER/YES** or **CURSOR→**.
The minute indication flashes.

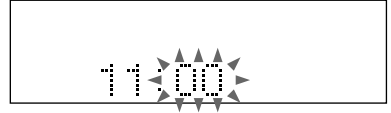

5 Press **◀** or **▶** to set the minute.

6 Press **ENTER/YES**.
The clock starts.

If you make a mistake

Press **CURSOR←** or **→** repeatedly until the incorrect item flashes, then set it again.

To change the preset time

You can change the preset time while the system is off.

1 Press **DISPLAY** to display the clock.

2 Press **CLOCK/TIMER SET**.

3 Repeat steps 3 to 6 of "Setting the time".

Tip

The upper dot of the colon flashes for the first 30 seconds, and the lower dot flashes for the last 30 seconds of each minute.

Step 3: Presetting radio stations

You can preset the following number of stations, 20 for FM and 10 for AM.

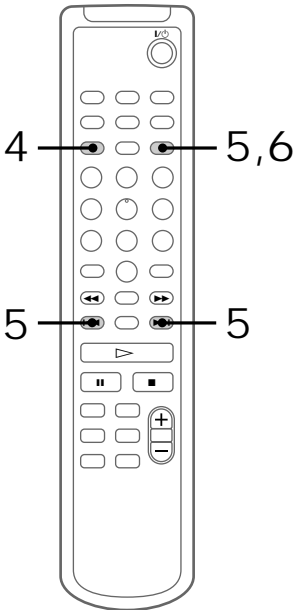
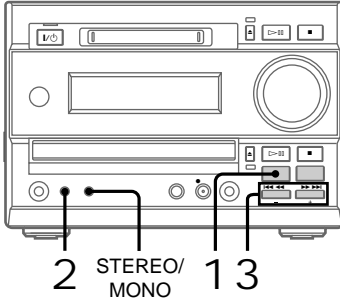

- 1 Press TUNER/BAND to select “FM” or “AM”.

Pressing TUNER/BAND turns on the system.

- 2 Press TUNING MODE repeatedly until “AUTO” appears.

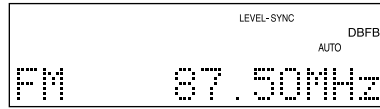

- 3 Press TUNING + or –.

The frequency indication changes and the scanning stops when the system tunes in a station. “TUNED” and “STEREO” (for a stereo programme) appear.

- 4 Press MENU/NO on the remote.

- 5 Press ◀◀ or ▶▶ on the remote repeatedly until “P.Memory ?” appears, then press ENTER/YES on the remote.

A preset number appears in the display. The stations are stored from preset number 1.

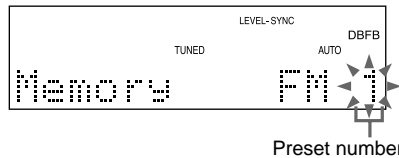

Preset number

- 6 Press ENTER/YES.

“Complete !!” appears, and then the station is stored.

- 7 Repeat steps 1 to 6 to preset other stations.

continued

Step 3: Presetting radio stations (continued)

To stop scanning

Press TUNING MODE.

To tune in a station with a weak signal

Press TUNING MODE repeatedly until “MANUAL” appears in step 2, then press TUNING + or – repeatedly to tune in the station manually.

To set another station to the exist preset number

Start over from step 1. After step 5, press ◀◀ or ▶▶ on the remote to select the preset number you want to store the other station.

You can add a new preset number after the last preset number.

To erase a preset station

- 1 Press MENU/NO on the remote.
- 2 Press ◀◀ or ▶▶ repeatedly until “P.Erase ?” appears.
Select “P.All Erase ?” when you want to erase all the preset stations.
- 3 Press ENTER/YES on the remote.
- 4 Press ◀◀ or ▶▶ repeatedly to select the preset number you want to erase.
- 5 Press ENTER/YES.
“Complete !!” appears.

When you erase a preset number, the preset number decreases by one and all preset numbers following the erased one are renumbered.

To change the AM tuning interval (except for the European model)

The AM tuning interval is factory-set to 9 kHz (10 kHz in some areas). To change the AM tuning interval, tune in any AM station first, then turn off the system. While holding down the TUNING MODE button, turn the system back on. When you change the interval, all the AM preset stations are erased. To reset the interval, repeat the same procedure.

Tips

- The preset stations are retained for about a day even if you disconnect the mains lead or if a power failure occurs.
- You can label the preset stations (see page 46).
- When an FM programme has static noise, press STEREO/MONO until “MONO” appears. There will be no stereo effect, but the reception will improve. Press the button again to restore the stereo effect.

Saving the power in standby mode

In order to conserve power, you can select whether or not to display the clock when the system is off. The system is set at the factory to not display the clock when the system is off (**Power Saving Mode**). To display the clock even when the system is off, deactivate the Power Saving Mode.

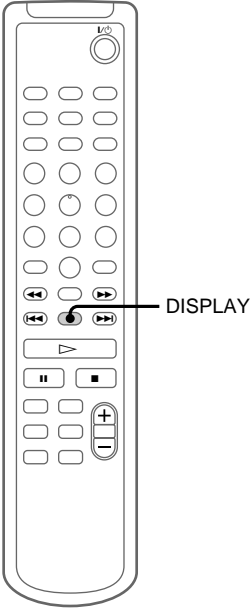

To activate Power Saving Mode
Press DISPLAY.

The clock display disappears.

Tips

- Each time you press DISPLAY in the Power Saving Mode, the display switches between the Power Saving Mode and the clock display.
- I/O indicator lights up even in the Power Saving Mode.

Note

When the timer is set, the Power Saving Mode does not function.

-
- ➔ Press DISPLAY when the system is off.
The system switches off the Power Saving Mode and the clock display appears.
-

Playing a CD

To turn on the system, press I/⏻ (power).

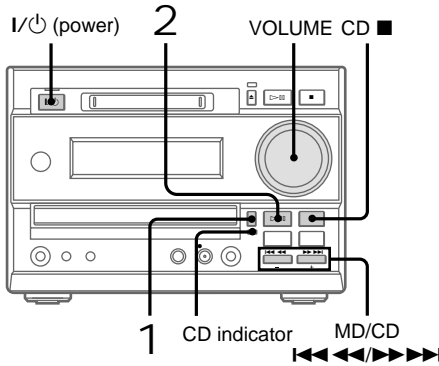

- 1 Press CD ▲ and place a CD on the disc tray.

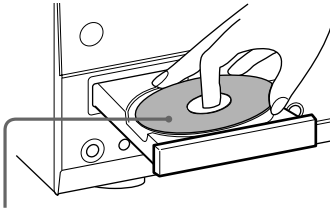

With the label side up. When you play a single CD, place it on the inner circle of the tray.

To close the disc tray, press CD ▲ again.

- 2 Press CD ▷◻◻.

The disc tray closes and play starts.

The ▷◻◻ indicator on the CD ▷◻◻ button lights green.

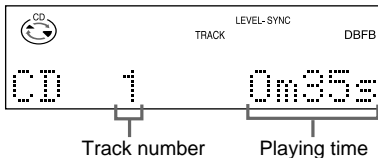

To	Do this
Stop play	Press CD ■.
Pause	Press CD ▷◻◻. The ◻◻ indicator on the CD ▷◻◻ button lights orange. Press again to resume play.
Select a track	Press MD/CD ◀◀◀◀ or ▶▶▶▶ repeatedly.
Find a point in a track	Keep pressing MD/CD ◀◀◀◀ or ▶▶▶▶ during play and release it at the desired point. “—OVER—” appears at the end of the CD.
Remove the CD	Press CD ▲.
Adjust the volume	Turn VOLUME.

Tips

- If you turn on the system when there is a CD on the disc tray, the CD indicator lights red.
- If there is no CD in the player, “CD No Disc” appears in the display.
- Pressing CD ▷◻◻ when the system is off automatically turns on the system and starts CD play if there is a CD on the disc tray (**One Touch Play**).
- You can switch from another source to the CD player and start playing a CD just by pressing CD ▷◻◻ (**Automatic Source Selection**).
- You can start playing from the desired track in step 2.

1 Press MD/CD ◀◀◀◀ or ▶▶▶▶ repeatedly until the desired track appears.

2 Press CD ▷◻◻.

Or, press the numeric buttons on the remote. The playback automatically starts. To enter track numbers 10 or over, press >10 and the track number. To enter 0, use the 10/0 button.

Notes

- Do not use a CD with tape, seals or paste on it as this may damage the CD player.
- Do not push the disc tray to close it, as this may damage the CD player. Press CD ▲ to close the disc tray.
- If you press CD ▲ to open or close the disc tray while listening to another sound source, the CD indicator lights red even if there is no CD in the tray.

To turn off the CD indicator, press FUNCTION repeatedly to switch the function to CD.

Recording a CD on an MD — CD-MD Synchro Recording

You can make a digital recording of a CD on an MD, marking track numbers in the same sequence as the original CD.

You can also record a programme of favourite tracks (see page 26).

To turn on the system, press I/⏻ (power).

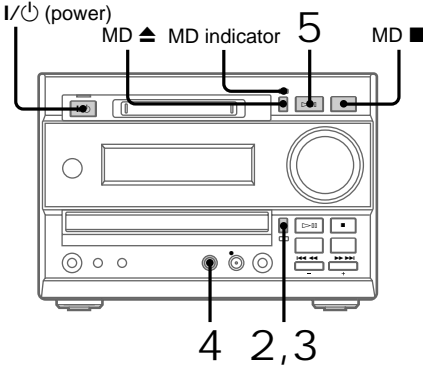

1 Insert a recordable MD.

With the arrow pointing toward the deck

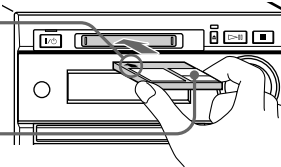

With the label side up, and the shutter on the righthand side

2 Press CD ▲ and place a CD on the disc tray.

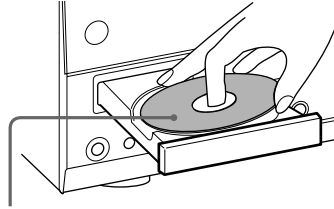

With the label side up. When you play a single CD, place it on the inner circle of the tray.

3 Press CD ▲ to close the disc tray.

4 Press CD-MD SYNC.

The MD deck stands by for recording and the CD player pauses for play.

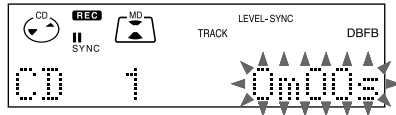

5 Press MD ▷||.

Recording starts. When the recording is completed, the CD player and the MD deck stop automatically.

To stop recording

Press MD ■.

Before inserting an MD

When the system is on, make sure the MD indicator is off. If the MD indicator is lit red, another MD is already inserted. Press MD ▲ and remove the MD.

continued

Recording a CD on an MD (continued)

Tips

- If you use a partially recorded MD, recording starts after the recorded tracks.
- The track numbers of the CD are recorded on to the MD automatically.
- Depending on the disc, CD TEXT information may also be recorded. If “TEXT” flashes during recording, press NAME EDIT, and then press ENTER/YES to record the title of the current track. (If “TEXT” is lit, it is automatically recorded.)
- You can adjust the recording level to the desired volume after performing step 3 (see page 33).

Before pulling out the mains lead

MD recording is completed when the MD Table of Contents (TOC) is updated. The TOC is updated when you eject the MD or press I/⏻ to turn off the system. Do not pull out the mains lead before updating the TOC (while “TOC” is lit) or while updating the TOC (while “TOC” is flashing) to ensure a complete recording.

If the MD becomes full during recording

The CD player and the MD deck stop automatically.

Note

If the MD is record protected, “C11” and “Protected” appear alternately and the MD cannot be recorded. Remove the MD, then slide the record protection tab to the closed position (see page 25).

Playing an MD

To turn on the system, press I/⏻ (power). You can play an MD just like a CD.

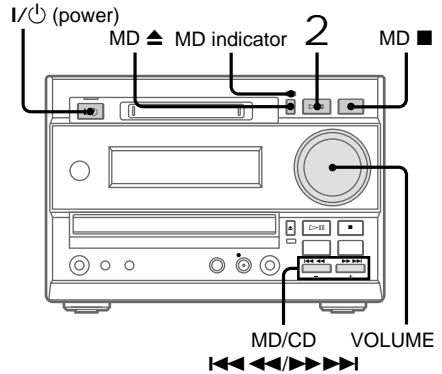

1 Insert an MD.

With the arrow pointing toward the deck

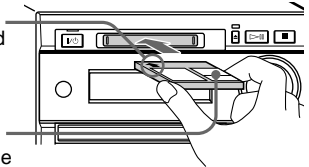

With the label side up, and the shutter on the righthand side

2 Press MD ▷||.

Play starts. The ▷ indicator on the MD ▷|| button lights green.

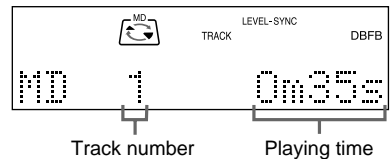

To	Do this
Stop play	Press MD ■.
Pause	Press MD ▷◁. The ◁◁ indicator on the MD ▷◁ button lights up orange. Press again to resume play.
Select a track	Press MD/CD ◀◀◀◀ or ▶▶▶▶ repeatedly.
Find a point in a track	Keep pressing MD/CD ◀◀◀◀ or ▶▶▶▶ during play and release it at the desired point.
Remove the MD	Press MD ▲.
Adjust the volume	Turn VOLUME.

Before inserting an MD

When the system is on, make sure the MD indicator is off. If the MD indicator is lit red, another MD is already inserted. Press MD ▲ and remove the MD.

Tips

- You can start playing from the desired track in step 2.
 - Press MD/CD ◀◀◀◀ or ▶▶▶▶ repeatedly until the desired track appears.
 - Press MD ▷◁.
 Or, press the numeric buttons on the remote. The playback automatically starts. To enter track numbers 10 or over, press >10 (press twice to enter 100 or over), then press the track number. To enter 0, use the 10/0 button.
- Pressing MD ▷◁ when the system is off automatically turns on the system and starts MD play if there is an MD in the system (**One Touch Play**).
- You can switch from another source to the MD deck and start playing an MD just by pressing MD ▷◁ (**Automatic Source Selection**).

Note

Do not use an MD on which the label sticks out from the edge or on which the label is not positioned correctly. Such labels can cause the MD deck to malfunction.

Listening to the radio

— Preset Tuning

Preset radio stations in the tuner's memory first (see page 7).
To turn on the system, press I/⏻ (power).

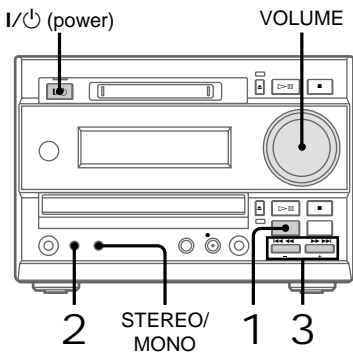

- Press TUNER/BAND to select “FM” or “AM”.
- Press TUNING MODE repeatedly until “PRESET” appears.

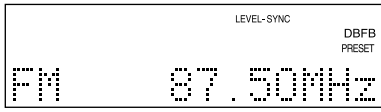

- Press TUNING + or – to select the desired preset station.

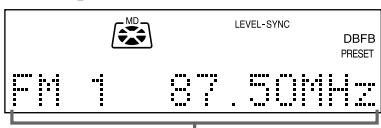

Preset number and frequency (or station name* or RDS station name**)

* The station name appears only if you have labelled the station (see page 46).
** European model only.
When you preset only one station, “ONE PRESET” appears in the display.

continued

Listening to the radio (continued)

To	Do this
Turn off the radio	Press I/⏻ to turn off the system.
Adjust the volume	Turn VOLUME.

To select the preset number using the remote

Press the numeric buttons on the remote in step 3. To enter preset numbers 10 or over, press >10 and the preset number. To enter 0, use the 10/0 button.

Listening to non-preset radio stations

- Press TUNING MODE repeatedly until “MANUAL” appears in step 2, then press TUNING + or – to tune in the desired station (**Manual Tuning**).
- Press TUNING MODE repeatedly until “AUTO” appears in step 2, then press TUNING + or –. The frequency indication changes and the scanning stops when the system tunes in a station (**Automatic Tuning**).

To cancel Automatic Tuning

Press TUNING MODE.

Tips

- Pressing TUNER/BAND when the system is off automatically turns on the system and tunes in the last received station (**One Touch Play**).
- You can switch from another source to the tuner just by pressing TUNER/BAND (**Automatic Source Selection**).
- To improve broadcast reception, adjust the supplied aerials, or connect a commercially available external aerial (see page 53).
- When an FM stereo programme has static noise, press STEREO/MONO until “MONO” appears. There will be no stereo effect, but the reception will improve. Press the button again to restore the stereo effect.

Recording from the radio — Manual Recording

You can analog record a radio programme on an MD. If you use a partially recorded MD, recording starts after the recorded tracks. To erase the recorded contents, see “Erasing recordings” on page 37.

To turn on the system, press I/⏻ (power).

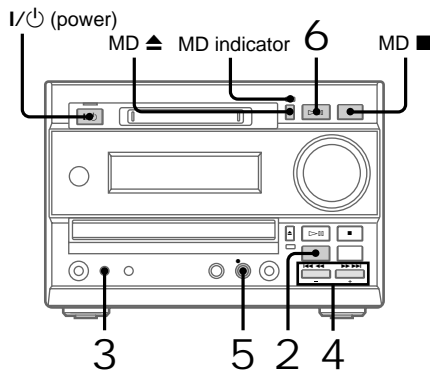

1 Insert a recordable MD.

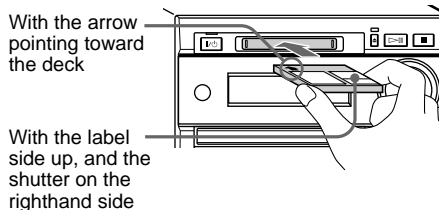

2 Press TUNER/BAND to select “FM” or “AM”.

3 Press TUNING MODE repeatedly until “PRESET” appears.

- 4 Press TUNING + or – to select the desired preset station.

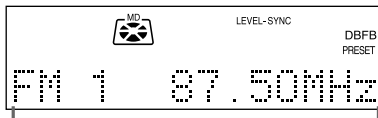

Preset number and frequency (or station name* or RDS station name**)

* The station name appears only if you have labelled the station (see page 46).

** European model only.

When you preset only one station, “ONE PRESET” appears in the display.

You can select the preset numbers with the numeric buttons on the remote.

- 5 Press ● REC.

The MD deck stands by for recording and the ● REC button lights red.

- 6 Press MD ▷▶▶.

Recording starts.

To stop recording

Press MD ■.

Before inserting an MD

When the system is on, make sure the MD indicator is off. If the MD indicator is lit red, another MD is already inserted. Press MD ▲ and remove the MD.

Tips

- If noise is heard while recording an AM radio programme, move the AM loop aerial to reduce the noise or connect a ground wire to the \hbar terminal (see page 53).
- If you select “MONO” in step 3, the MD is recorded in monaural format. For details, see “Monaural recording” on page 34.
- You can adjust the recording level to the desired volume after performing step 5 (see page 33).

Before pulling out the mains lead

MD recording is completed when the MD Table of Contents (TOC) is updated. The TOC is updated when you eject the MD or press I/⏻ to turn off the system. Do not pull out the mains lead before updating the TOC (while “TOC” is lit) or while updating the TOC (while “TOC” is flashing) to ensure a complete recording.

Note

If the MD is record protected, “C11” and “Protected” appear alternately and the MD cannot be recorded. Remove the MD, then slide the record protection tab to the closed position (see page 25).

Playing CD tracks repeatedly — Repeat Play

You can repeat a CD in normal play, Shuffle Play and Programme Play.

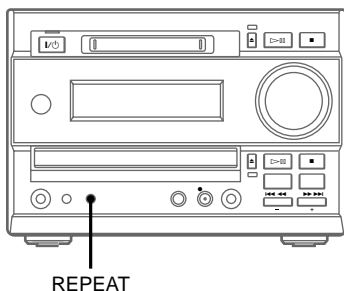

- ➔ Press REPEAT until “REPEAT” or “REPEAT 1” appears.

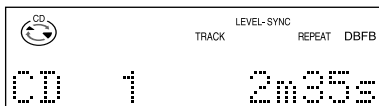

REPEAT: For all the tracks on the CD.
REPEAT 1: For a single track only.

To cancel Repeat Play

Press REPEAT until “REPEAT” or “REPEAT 1” disappears.

Playing CD tracks in random order — Shuffle Play

You can play all the tracks on a CD in random order.

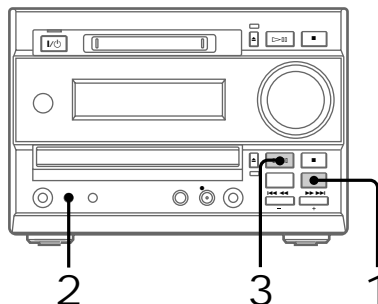

- 1 Press FUNCTION repeatedly until “CD” appears.

- 2 Press PLAY MODE repeatedly until “SHUFFLE” appears.

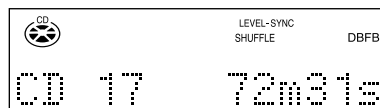

- 3 Press CD ▶▶▶▶.
Shuffle Play starts.

To cancel Shuffle Play

Press PLAY MODE repeatedly until “SHUFFLE” and “PGM” disappear.

Tips

- You can start Shuffle Play during normal play by displaying “SHUFFLE.”
- To skip a track, press MD/CD ▶▶▶▶▶.

Programming CD tracks

— Programme Play

You can make a programme of up to 25 tracks in the order you want them to be played. You can also make a Synchro Recording of the programme on the MD (see page 26).

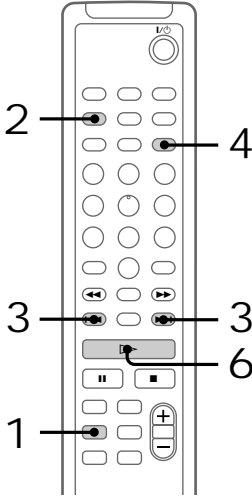

1 Press CD to switch the function to CD.

2 Press PLAY MODE repeatedly until “PGM” appears.



3 Press **◀◀** or **▶▶** repeatedly until the desired track appears in the display.

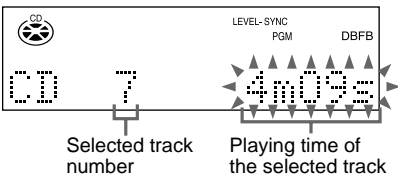

4 Press ENTER/YES.

The track is programmed.

“Step” appears, followed by the number of the track in the programmed sequence. The number of the last programmed track appears, followed by the total playing time of the programme. If you have made a mistake, you can clear the last programmed track from the programme by pressing CLEAR.

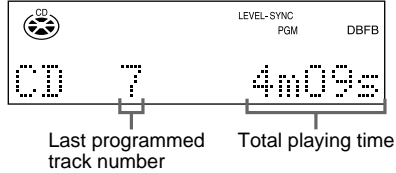

5 To programme additional tracks, repeat steps 3 and 4.

6 Press **▶**.

All the tracks play in the order you selected.

To check the total number of programmed tracks

Press DISPLAY in stop mode. The total number of programmed steps appears, followed by the last programmed track number and the total playing time of the programme.

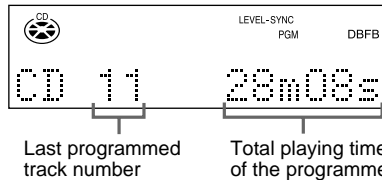

continued

Programming CD tracks (continued)

To check the programme order

Press ◀◀ or ▶▶ repeatedly during Programme Play.

To	Do this
Cancel Programme Play	Press ■, then press PLAY MODE repeatedly until "PGM" and "SHUFFLE" disappear.
Add a track to the programme (in stop mode)	Do steps 3 and 4.
Erase the entire programme	Press ■, when Programme Play is in stop mode.

To select the desired track using the remote

Press numeric buttons instead of performing steps 3 to 5.

To enter track numbers 10 or over, press >10 and the track number. To enter 0, use the 10/0 button.

Tips

- The programme you made remains after Programme Play finishes. To play the same programme again, press ▷.
- "Step Full" appears when you try to programme 26 or more tracks (steps).
- "--m--s" appears when the total CD programme time exceeds 100 minutes, or when you select a CD track whose number is 21 or over.

Using the CD display

You can check the remaining time on the current track or on the CD. When a CD TEXT disc is loaded, you can check the information recorded on the disc, such as the titles or artist names.

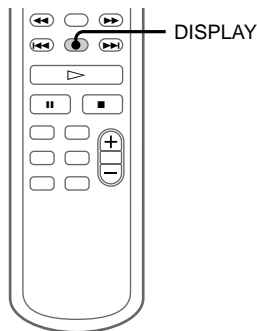

➔ Press DISPLAY.

Each time you press the button during normal play or in stop mode, the display changes as follows:

During normal play

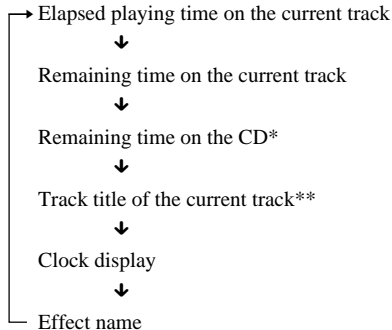

In stop mode

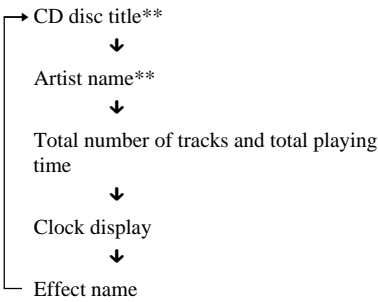

* The remaining time of the programme appears during Programme Play.

** If a CD that has no title is loaded, nothing appears. When the CD contains more than 50 tracks, CD TEXT is not displayed from track 51 on.

Labelling a CD — Disc Memo

You can label up to 50 CDs with titles of up to 20 symbols and characters. Whenever you load a labelled CD, the title appears in the display.

Notes

- You cannot label a CD for which “TEXT” appears in the display.
- **When labelling CDs for the first time, be sure to perform the operations in “Erasing all disc titles stored in the system memory” on page 21 beforehand.**

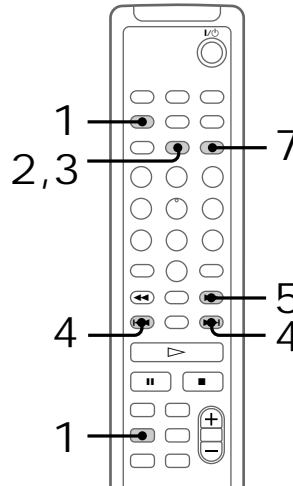

- 1 Press CD to switch the function to CD. Make sure the total number of tracks and the total playing time appear in the display in stop mode. If “SHUFFLE” or “PGM” appears in the display, press PLAY MODE repeatedly until both disappear.

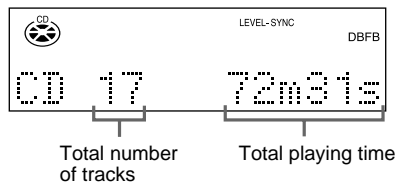

continued

Labelling a CD (continued)

2 Press NAME EDIT.

The text input screen appears, and the cursor flashes.

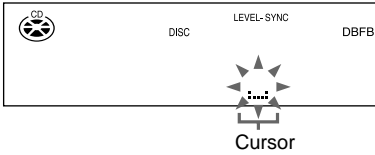

3 Press CHARACTER to select the desired type of character.

Each time you press the button, the display changes as follows:

□ (Blank space) → A (Upper cases) → a (Lower cases) → 0 (Numbers) → + (Symbols) → □ (Blank space) → ..

4 Press ◀◀ or ▶▶ repeatedly to select the desired character.

To enter a black space

Press CURSOR→ without pressing ◀◀ or ▶▶. You cannot enter a space as the first character.

To enter a symbol

You can use the following 24 symbols.

! " # \$ % & ' () * + , - . / : ; < = > ? @ _ `

5 Press CURSOR→

The character you selected in step 4 stops flashing and the cursor shifts to the right.

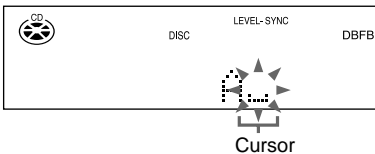

6 Repeat steps 3 to 5 to complete the entire title.

If you make a mistake

Press CURSOR← or → until the character you want to change flashes, then repeat steps 3 to 5.

To erase a character

Press CLEAR while the character is flashing. You cannot insert characters.

7 Press ENTER/YES to complete the labelling procedure.

The disc title is stored in the system memory and then the original display appears.

To cancel labelling

Press MENU/NO.

Checking the disc titles

1 Press MENU/NO in stop mode.

2 Press ◀◀ or ▶▶ repeatedly until "Name Check ?" appears, then press ENTER/YES.

3 Press ◀◀ or ▶▶ repeatedly to select the disc titles stored in the system memory between 01 and 50.

To check the current disc title

Press SCROLL in stop mode.

Erasing a disc title

- 1 Press MENU/NO in stop mode.
- 2 Press ◀◀ or ▶▶ repeatedly until “Name Erase ?” appears, then press ENTER/YES. The disc title appears scrolling in the display. “No Name” appears if no disc title is labelled.
- 3 Press ENTER/YES again. “Complete !!” appears and the disc title is erased.

To cancel erasing

Press MENU/NO during steps 1 and 2.

Erasing all disc titles stored in the system memory

- 1 Press MENU/NO in stop mode.
- 2 Press ◀◀ or ▶▶ repeatedly until “All Erase ?” appears, then press ENTER/YES. “All Erase ??” appears.
- 3 Press ENTER/YES again to erase disc titles. “Complete !!” appears and all disc titles are erased.

To cancel erasing

Press MENU/NO during steps 1 and 2.

Note

To ensure that disc titles are not erased from memory, have the system connected to mains power at least once a month.

Playing MD tracks repeatedly — Repeat Play

You can repeat an MD in normal play, Shuffle Play and Programme Play.

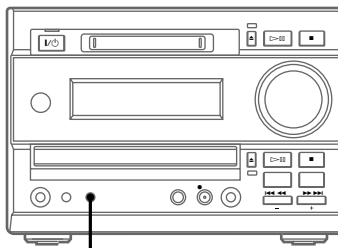

REPEAT

- Press REPEAT during play until “REPEAT” or “REPEAT 1” appears.

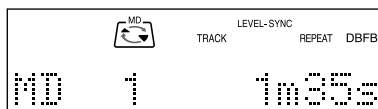

REPEAT: For all the tracks on the MD.

REPEAT 1*: For a single track only.

* You cannot repeat a single track during Shuffle Play or Programme Play.

To cancel Repeat Play

Press REPEAT until “REPEAT” or “REPEAT 1” disappears.

Playing MD tracks in random order — Shuffle Play

You can play all the tracks on an MD in random order.

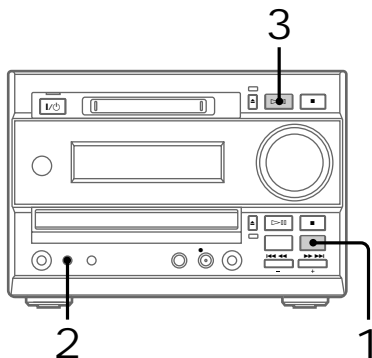

- 1 Press FUNCTION repeatedly until “MD” appears.
- 2 Press PLAY MODE repeatedly until “SHUFFLE” appears in stop mode.

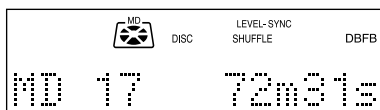

- 3 Press MD Shuffle Play starts.

To cancel Shuffle Play

Press MD to stop Shuffle Play, then press PLAY MODE repeatedly until “SHUFFLE” and “PGM” disappear.

Tip

To skip a track, press MD/CD .

Programming MD tracks — Programme Play

You can make a programme of up to 25 tracks in the order you want them to be played.

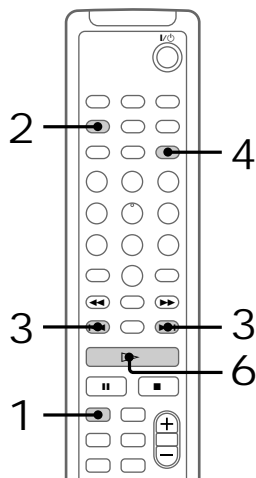

- 1 Press MD to switch the function to MD.
- 2 Press PLAY MODE repeatedly until “PGM” appears in stop mode.
- 3 Press repeatedly until the desired track appears in the display.

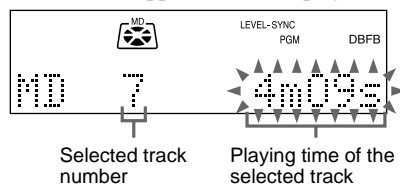

Selected track number

Playing time of the selected track

4 Press ENTER/YES.

The track is programmed. “Step” appears, followed by the number of the track in the programmed sequence. The number of the last programmed track appears, followed by the total playing time of the programme. If you have made a mistake, you can clear the last programmed track from the programme by pressing CLEAR.

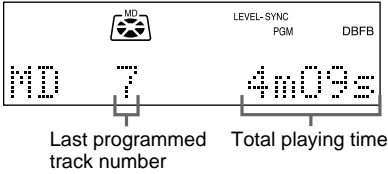

5 To programme additional tracks, repeat steps 3 and 4.

6 Press ▷ All the tracks play in the order you selected.

To check the total number of programmed tracks

Press DISPLAY in stop mode. The total number of programmed steps appears.

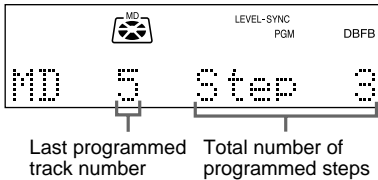

To check the programme order

Press ◀▶ repeatedly during Programme Play.

To	Do this
Cancel Programme Play	Press ■, then press PLAY MODE repeatedly until “PGM” and “SHUFFLE” disappear.
Add a track to the programme (in stop mode)	Do steps 3 and 4.
Erase the last programmed track	Press CLEAR in stop mode. Each time you press the button, the last programmed track is erased.

To select the desired track using the remote

Press numeric buttons instead of performing steps 3 to 5.

To enter track numbers 10 or over, press >10 (press twice to enter 100 or over) and the track number. To enter 0, use the 10/0 button.

Tips

- The programme you made remains after Programme Play finishes. To play the same programme again, press ▷.
- “Program Full !” appears when you try to programme 26 or more tracks (steps).
- “---m--s” appears when the total MD programme time exceeds 200 minutes.

Using the MD display

You can check the total number of tracks, the total playing time and the remaining time on the MD.

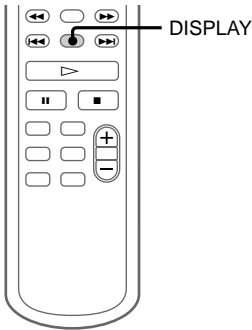

➔ Press DISPLAY.

Each time you press the button during normal play or in stop mode, the display changes as follows:

During normal play

- ➔ Elapsed playing time and the track number on the current track
- ↓
- Remaining time and the track number on the current track
- ↓
- Remaining time on the MD
- ↓
- Track title of the current track*
- ↓
- Clock
- ↓
- Effect name

* "No Name" appears when no track title is labelled.

In stop mode

- ➔ Total number of tracks and total playing time
- ↓
- Remaining recordable time (Only for a recordable MD)
- Disc title appears for a pre-mastered MD.
- ↓
- Disc title**
- ↓
- Clock
- ↓
- Effect name

** "No Name" appears if no disc title is labelled.

Tips

- You can check a track title at any time during play. If you press SCROLL, a track title appears scrolling in the display.
- To label a disc title or a track title, see "Labelling an MD" on page 36.

Before you start recording

MDs (Mini Disc) let you digitally record and play music with high quality sound. Another feature of MDs is track marking. The track marking feature lets you quickly locate a specific point or easily edit the recorded tracks. However, depending on the source you record, the recording method and the way the track numbers are recorded differ.

When the source you record from is:

- This system's CD player
 - The MD deck performs digital recording.*¹
 - Track numbers are automatically marked as on the original CD.
- Other digital components connected to the DIGITAL OPTICAL IN jack (e.g., CS/BS tuner)
 - The MD deck performs digital recording.*¹
 - Track numbers are marked differently depending on the source you record.
- This system's tuner and other analogue components connected to the TAPE IN jacks or LINE IN jack (e.g., the optional tape deck TC-TX373)
 - The MD deck performs analogue recording.*²
 - A track number is marked at the beginning of a recording, but when you turn on the Level Synchro Recording function (see page 30), track numbers are automatically marked in sync with the level of the input signal.

*¹ For details on the limitations of digital recording, see page 55.

*² If a digital component is not connected to the DIGITAL OPTICAL IN jack using a digital connecting cable, the MD deck performs analogue recording.

Note on MD track numbers

On an MD, the track numbers (track sequence), track start and end point information, etc., are recorded in the TOC*³ area independent of the sound information. You can edit recorded tracks quickly by modifying the TOC information.

*³ TOC: Table Of Contents

After recording

➔ Press MD ▲ to remove the MD or press I/⏻ (power) to turn off the system.

“TOC” lights up or starts flashing. The TOC is updated and recording is completed.

Before pulling out the mains lead

MD recording is completed when the MD Table of Contents (TOC) is updated. The TOC is updated when you eject the MD or press I/⏻ to turn off the system. Do not pull out the mains lead before updating the TOC (while “TOC” is lit) or while updating the TOC (while “TOC” is flashing) to ensure a complete recording.

Protecting a recorded MD

- To protect a recorded MD, slide the tab on the side of the MD to open the slot. In this position, the MD cannot be recorded. To record on the MD, slide the tab to close the slot.

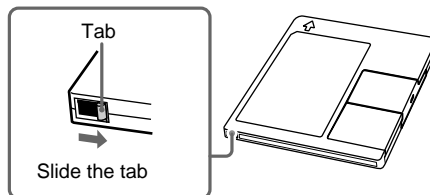

- If the MD is record protected, “C11” and “Protected” appear alternately and the MD cannot be recorded. Remove the MD, then slide the record protection tab to the closed position.

Recording your favourite CD tracks on an MD

— CD-MD Synchro Recording

You can select your favourite CD tracks with the Programme Play feature, then record the programme on an MD using the CD Synchro Recording feature. If you use a partially recorded MD, recording starts after the recorded tracks.

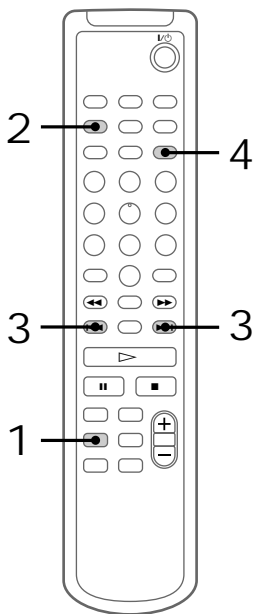
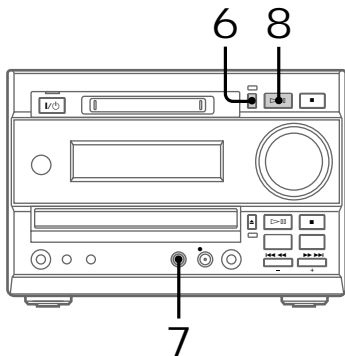

Selecting the tracks

- 1 Press CD on the remote to switch the function to CD.
- 2 Press PLAY MODE on the remote repeatedly until "PGM" appears.
- 3 Press **◀◀** or **▶▶** on the remote repeatedly until the desired track number appears.

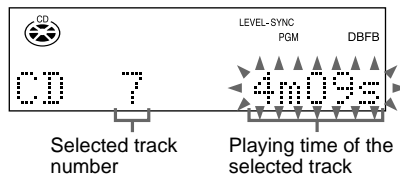

- 4 Press ENTER/YES on the remote. The track is programmed. "Step" appears, followed by the number of the track in the programmed sequence. The number of the last programmed track appears, followed by the total playing time of the programme.

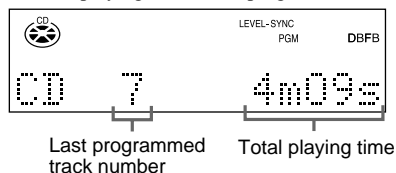

- 5 To programme additional tracks, repeat steps 3 and 4.

Recording on an MD

- 6 Insert a recordable MD. If the MD indicator lights red, another MD is already inserted. Press MD **▲** and remove the MD.
- 7 Press CD-MD SYNC. The MD deck stands by for recording and the CD player pauses for play.

8 Press MD ▷◻◻◻.

CD playing and MD recording start. The CD player and the MD deck stop automatically when the recording is completed.

To stop recording

Press MD ■.

If the MD becomes full during recording, the MD deck and the CD player automatically stop.

Tips

- The track numbers of the CD are recorded on to the MD automatically.
- You can adjust the recording level to the desired volume after performing step 3 (see page 33).

Before pulling out the mains lead

MD recording is completed when the MD Table of Contents (TOC) is updated. The TOC is updated when you eject the MD or press I/⏻ to turn off the system. Do not pull out the mains lead before updating the TOC (while “TOC” is lit) or while updating the TOC (while “TOC” is flashing) to ensure a complete recording.

Note

If the MD is record protected, “C11” and “Protected” appear alternately and the MD cannot be recorded. Remove the MD, then slide the record protection tab to the closed position (see page 25).

Labelling titles during recording

If “CD TEXT” lights up or flashes during recording, you can record the CD TEXT information on to the MD as follows:

- Automatically during recording
If you record on an unrecorded or completely erased (see page 38) MD when “CD TEXT” is lit, the CD TEXT information is automatically recorded.
- Manually during recording
When “CD TEXT” flashes, press NAME EDIT on the remote, and then press ENTER/YES on the remote to record the title of the current track.

Note

Depending on the disc, the CD TEXT information may not be recorded automatically.

Recording on an MD manually — Manual Recording

If you use a partially recorded MD, recording starts after the recorded tracks.

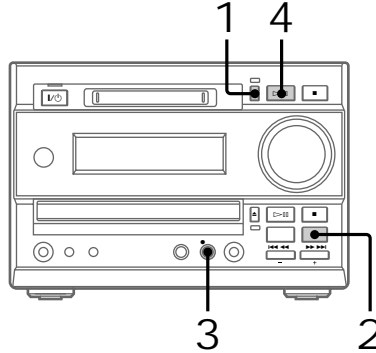

1 Insert a recordable MD.

If the MD indicator is lit red, another MD is already inserted. Press MD ▲ and remove the MD.

2 Press FUNCTION repeatedly to select the desired source (e. g., TUNER) to record.

- CD: Recording from the CD
- TUNER: Recording from the radio

3 Press ● REC.

The MD deck stands by for recording.

4 Press MD ▷◻◻◻.

Recording starts.

continued

Recording on an MD manually (continued)

- 5 Start playing the desired source (CD, etc.) to record.
- When recording from this system's CD player, the track numbers are automatically marked. Press ● REC during recording to mark the track numbers at the desired point. If you want to mark track numbers automatically during recording from the radio, see "Marking track numbers" on page 30.

To stop recording

Press MD ■.

Before pulling out the mains lead MD recording is completed when the MD Table of Contents (TOC) is updated. The TOC is updated when you eject the MD or press I/⏻ to turn off the system. Do not pull out the mains lead before updating the TOC (while "TOC" is lit) or while updating the TOC (while "TOC" is flashing) to ensure a complete recording.

Tips

- You can adjust the recording level to the desired volume after performing step 3 (see page 33).
- You can check the remaining recordable time on the MD during recording by pressing DISPLAY on the remote.

Note

If you pause recording during CD recording, a track number is recorded at that point. Also, note that the tracks might be recorded as the same single track with a single track number when the same single track of the same CD is recorded repeatedly.

Starting recording with 6 seconds of prestored audio data

— Time Machine Recording

When recording from an FM or satellite broadcast, the first few seconds of material are often lost due to the time it takes you to ascertain the contents and press the record button. To prevent the loss of this material, the Time Machine Recording feature constantly stores the most recent audio data in a buffer memory. This lets you record the sound from 6 seconds (12 seconds for monaural recording) before starting recording, as shown in the illustration below:

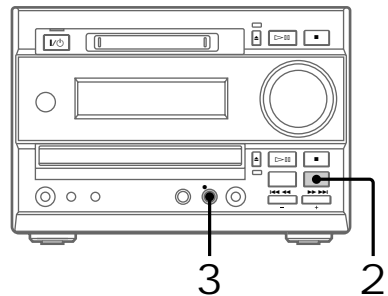
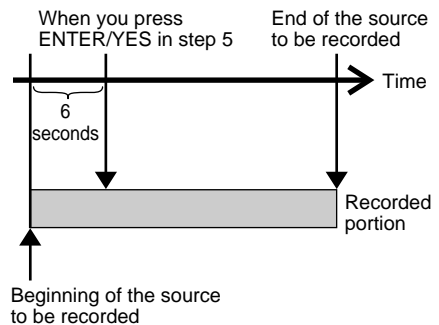

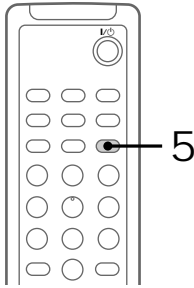

Before pulling out the mains lead

MD recording is completed when the MD Table of Contents (TOC) is updated. The TOC is updated when you eject the MD or press I/⏻ to turn off the system. Do not pull out the mains lead before updating the TOC (while "TOC" is lit) or while updating the TOC (while "TOC" is flashing) to ensure a complete recording.

Note

The MD deck starts storing audio data when the deck stands by for recording in step 3 and you start playing the source. If less than 6 seconds have passed when you press ENTER/YES on the remote, Time Machine Recording starts with less than 6 seconds of audio data.

- 1 Insert a recordable MD.
- 2 Press FUNCTION repeatedly until the desired source (i.e., TUNER) to record appears.
- 3 Press ● REC.
The MD deck stands by for recording.
- 4 Start playing the desired source to record.
- 5 Press ENTER/YES on the remote at the desired point to start recording.
Recording of the source starts with the 6 seconds of audio data stored in the buffer memory.
If you use a partially recorded MD, recording starts after the recorded tracks.

To stop Time Machine Recording

Press MD ■.

Marking track numbers

You can mark track numbers:

- **Automatically during recording**

Track numbers are automatically marked as on the original source during recording from this system's CD player or components connected to the DIGITAL OPTICAL IN jack. Use the Level Synchro Recording function to automatically mark track numbers during recording from this system's tuner or components connected to the LINE IN jack or the TAPE IN jacks. However, you cannot mark track numbers automatically if the sound source to be recorded is noisy (e.g., tapes or radio programmes) or during timer-recording.

- **At any point during recording**

You can mark track numbers during recording any sources.

- **After recording**

Use the Divide Function (see page 41).

Marking track numbers automatically during recording — Level-Synchro Recording

The Level Synchro Recording function is factory set to on, so the track numbers are automatically marked. If “LEVEL-SYNC” does not appear during recording, turn on the Level Synchro Recording as follows. Track numbers are automatically marked when the input signal is continuously below a certain level for more than two seconds and then exceeds that level.

Note

You can not mark track numbers automatically if the sound source to be recorded is noisy (e.g., tapes or radio programmes).

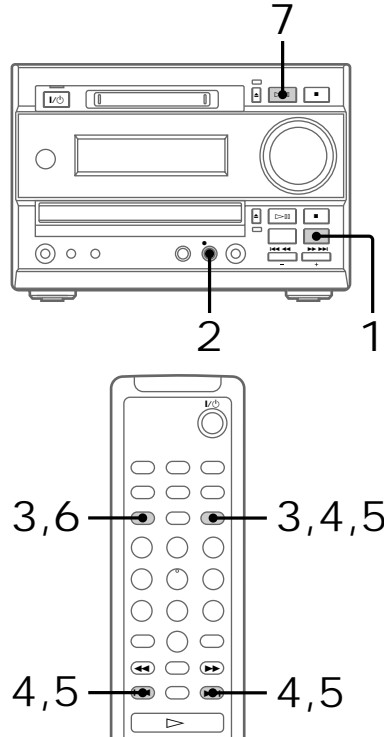

- 1 Press **FUNCTION** repeatedly until “TUNER” appears.
To record from other components connected to this system, select “TAPE” or “LINE IN”.
- 2 Press **REC** to stand by for recording.
- 3 Press **MENU/NO** on the remote. “Setup ?” appears, then press **ENTER/YES** on the remote.
- 4 Press **◀◀** or **▶▶** on the remote repeatedly until “T.Mark Off” appears, then press **ENTER/YES**.
- 5 Press **◀◀** or **▶▶** repeatedly until “T.Mark LSync” appears, then press **ENTER/YES**.
“LEVEL-SYNC” lights up.

6 Press MENU/NO.

7 Press MD ▷◻◻.
Recording starts.

To stop recording

Press MD ■.

To cancel automatic track marking

- 1 Press MENU/NO on the remote during recording pause. "Setup ?" appears, then press ENTER/YES on the remote.
- 2 Press ◀◀ or ▶▶ on the remote repeatedly until "T.Mark LSync" appears, then press ENTER/YES.
- 3 Press ◀◀ or ▶▶ repeatedly until "T.Mark Off" appears, then press ENTER/YES.
- 4 Press MENU/NO.
"LEVEL-SYNC" disappears.

When "LEVEL-SYNC" is off, a track number is marked only at the beginning of each recording.

Marking track numbers at a specific point during recording — Track Mark

You can mark track numbers at any time during recording, regardless of the type of sound source.

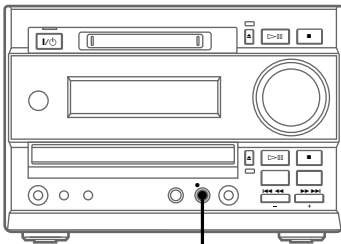

● REC

- ➔ Press ● REC during recording at the point you want to add a track mark.
The tracks following the added one are renumbered.

Making a space between tracks 3 seconds long — Smart Space

The Smart Space function lets you make the blank spaces between tracks 3 seconds long automatically while making a digital recording from a CD. For other types of recording, if the Smart Space function is on and there is no sound input for about 3 seconds or more (but less than 30 seconds) while recording, the MD deck replaces this silence with a blank of about 3 seconds and continues recording.

No sound input for less than 30 seconds

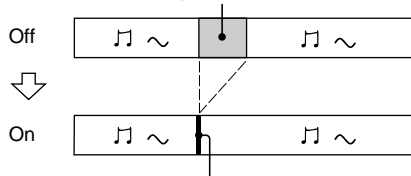

Replaced with a blank of 3 seconds and recording continues

Auto Cut: When the Smart Space function is on, if there is no sound input for 30 seconds or more, the MD deck replaces this silence with a blank of about 3 seconds and enters recording pause.

No sound input for 30 seconds or more

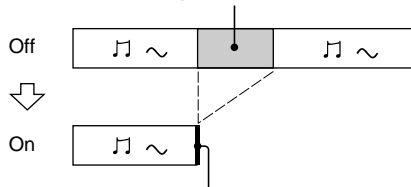

Replaced with a blank of 3 seconds and recording pauses

continued

Making a space between tracks
3 seconds long (continued)

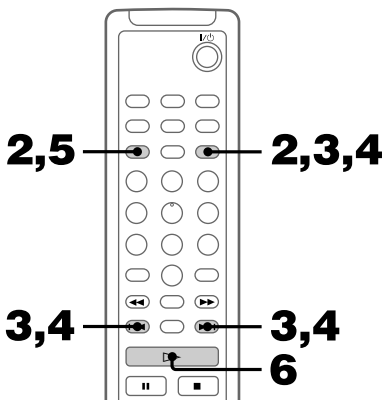
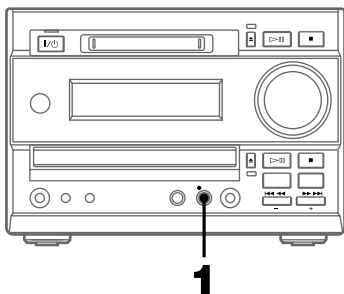

-
- 1 Press ● REC to stand by for recording.

 - 2 Press MENU/NO on the remote.
“Setup ?” appears, then press ENTER/YES on the remote.

 - 3 Press ◀◀ or ▶▶ on the remote repeatedly until “S.Space Off” (or “S.Space On”) appears, then press ENTER/YES.

4 Press ◀◀ or ▶▶ repeatedly until “S.Space On” appears, then press ENTER/YES.

5 Press MENU/NO.

6 Press ▷ on the remote.
Recording starts.

If there is an extended silence of less than 30 seconds, “Smart Space” appears, and the MD deck replaces the silence with a blank of about 3 seconds and continues recording. If there is no sound input for 30 seconds or more, “Auto Cut” appears, and the MD deck replaces the silence with a blank of about 3 seconds and switches to recording pause. Press ▷ to restart the recording.

To stop recording

Press MD ■.

To turn off Smart Space and Auto Cut functions

- 1 Press MENU/NO on the remote during recording pause.
“Setup ?” appears, then press ENTER/YES on the remote.
- 2 Press ◀◀ or ▶▶ on the remote repeatedly until “S.Space On” appears, then press ENTER/YES.
- 3 Press ◀◀ or ▶▶ repeatedly until “S.Space Off” appears, then press ENTER/YES.
- 4 Press MENU/NO.

Tip

The Smart Space and Auto Cut functions are factory set to on. If you turn off the system or disconnect the mains lead, the MD deck will retain the last setting (S.Space On or Off).

Adjusting the recording level

When recording on an MD, you can adjust the recording level to the desired volume. You can adjust the recording level not only when making an analogue recording, but also when making a digital recording from a CD, etc.

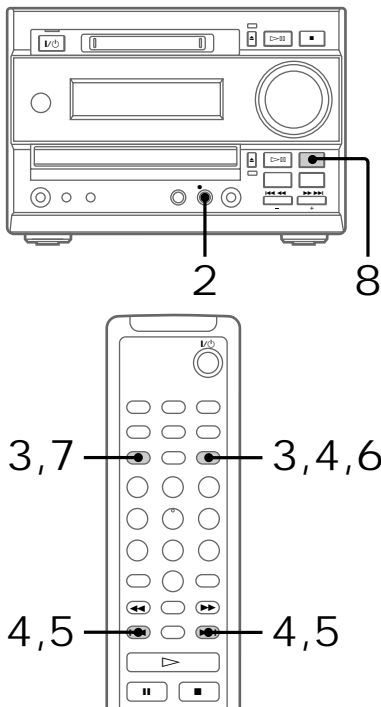

- 1 Prepare the desired sound source to record and start play.
- 2 Confirm that the MD deck is in recording standby.
If not, press ● REC.

- 3 Press MENU/NO on the remote.
“Setup ?” appears, then press ENTER/YES on the remote.

- 4 Press ◀◀ or ▶▶ on the remote repeatedly until “Level Adjust ?” appears, then press ENTER/YES.

- 5 Press ◀◀ or ▶▶ to adjust the recording level.

The recording level can be adjusted from -12 to +12. While monitoring the sound, adjust to the optimum level while making sure that “OVER” does not appear in the display at the loudest portion. The level meter appears in the display while adjusting the level. (The left channel is on the top, and the right channel is on the bottom.)

Adjust the level so that “OVER” does not appear

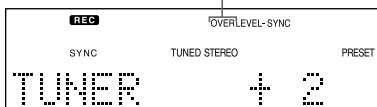

- 6 Press ENTER/YES.
- 7 Press MENU/NO.
- 8 When a CD or other sound source is playing, press ■ on the system to stop playback.
To continue and record, follow the procedures described on the various recording pages.

Tips

- You can also adjust the recording level during recording. Do steps 3 to 7 during recording.
- Once adjusted, the recording level is maintained until you adjust it again.

Monaural recording

Stereo signals such as an FM stereo broadcast can be converted to monaural format and recorded. When recording in monaural format, the MD recording time is approximately twice the normal recording (stereo recording) time (i.e., 120 minutes of monaural audio can be recorded on a 60-minute MD).

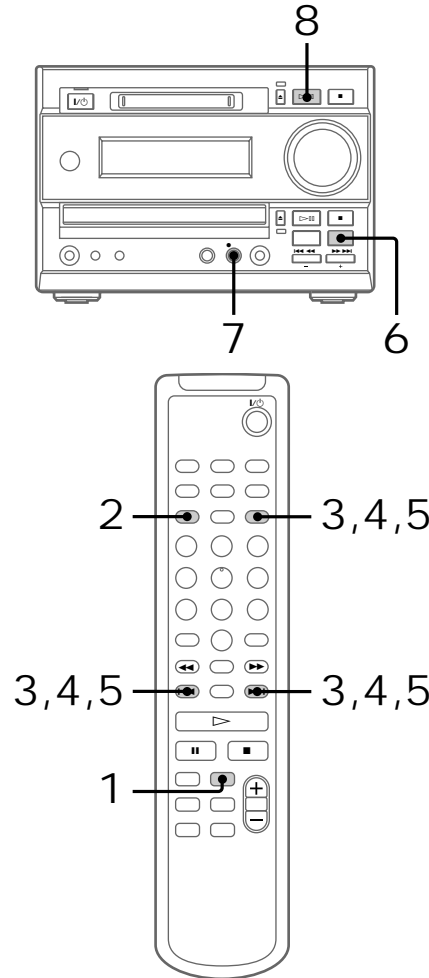

- 1 Press MD on the remote to switch the function to MD.

- 2 Press MENU/NO on the remote in stop mode.
- 3 Press ◀◀ or ▶▶ on the remote repeatedly until "Setup ?" appears, then press ENTER/YES on the remote.
- 4 Press ◀◀ or ▶▶ repeatedly until "Stereo Rec" (or "Mono Rec") appears, then press ENTER/YES.
- 5 Press ◀◀ or ▶▶ repeatedly until "Mono Rec" appears, then press ENTER/YES. "MONO" lights up.
- 6 Press FUNCTION repeatedly to select the desired sound source (e.g., TUNER) to record.
- 7 Press ● REC.
The MD deck stands by for recording.
- 8 Press MD ▷◻◻.
Recording starts.
The sound source is heard as is (e.g., stereo sound when recording a stereo broadcast) from the speakers.

To stop recording

Press MD ■.

To return to stereo recording

- 1 Press MENU/NO on the remote in stop mode and then ◀◀ or ▶▶ on the remote repeatedly until "Setup ?" appears, then press ENTER/YES on the remote.
- 2 Press ◀◀ or ▶▶ repeatedly until "Mono Rec" appears, then press ENTER/YES.
- 3 Press ◀◀ or ▶▶ repeatedly until "Stereo Rec" appears, then press ENTER/YES.
The system switches back to stereo recording, and "MONO" lights off.

Before you start editing

You can edit the recorded tracks on an MD. By using the editing functions, you can create a new sequence to the recorded MD.

Editing functions

- **Name — Labelling MDs (page 36)**
Use this function to label discs and tracks. You can use upper case, lower case, numbers, and symbols for the titles.
- **Erase — Erasing recordings (page 37)**
Use this function to erase a single track one by one, all the tracks at once, or a portion of a track.
- **Move — Changing the order of tracks (page 40)**
Use this function to change the track numbering.
- **Divide — Adding track numbers (page 41)**
Use this function to add track numbers. This lets you locate your favourite phrases quickly.
- **Combine — Combining recorded tracks (page 42)**
By using this function, two tracks are combined to a single track. You can combine the tracks which are not numerically consecutive, i.e. the track 1 and track 4, etc.
- **Undo — Cancelling the last edit (page 44)**
Use this function to cancel the last edit and restore the contents of the MD to the condition before the edit.

Before editing

You can edit an MD only when:

- The MD is recordable.
- The MD play mode is normal play.

Check the following, before editing.

- 1 Check the tab of the MD to be edited.
If the MD is protected, “C11” and “Protected” appear alternately and the MD cannot be edited.
Slide the tab to close the slot.

- 2 Press PLAY MODE repeatedly until both “PGM” and “SHUFFLE” disappear.
You can edit the MD only in normal play mode. You cannot edit the MD in Shuffle or Programme Play mode.

After editing

- ➔ Press MD ▲ to remove the MD or press I/⏻ (power) to turn off the system.
“TOC” lights up or starts flashing. The TOC is updated and editing is completed.

Before pulling out the mains lead MD editing is completed when the MD Table of Contents (TOC) is updated. The TOC is updated when you eject the MD or press I/⏻ to turn off the system. Do not pull out the mains lead before updating the TOC (while “TOC” is lit) or while updating the TOC (while “TOC” is flashing) to ensure a complete editing.

Labelling an MD

— Name Function

You can create titles for your recorded MDs and tracks as follows.

During recording

If “CD TEXT” flashes in the display during recording a CD, you can record the CD disc title on the MD (see page 27).

After recording

Use Name Function on this page. You can input a total of approximately 1700 characters for the disc title and track titles on a single MD.

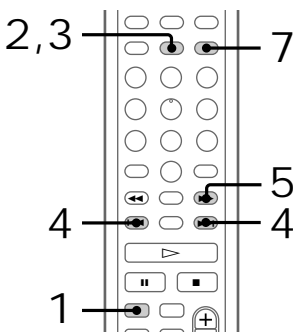

1 Press MD to switch the function to MD. To label a track, press **◀** or **▶** until the desired track number appears.

2 Press NAME EDIT. The text input screen appears, and the cursor flashes.

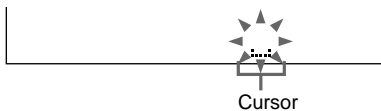

3 Press CHARACTER to select the desired type of character. Each time you press the button, the display changes as follows:
□ (Blank space) → A (Upper cases) → a (Lower cases) → 0 (Number) → ! (Symbols) → □ (Blank space) → ...

4 Press **◀** or **▶** repeatedly to select the desired character.

To enter a blank space
Press CURSOR→ without pressing **◀** or **▶**. You cannot enter a space as the first character.

To enter a symbol
You can use the following 24 symbols.
! " # \$ % & ' () * + , - . / : ; < = > ? @ _ `

5 Press CURSOR→
The character you selected in step 4 stops flashing and the cursor shifts to the right.



6 Repeat steps 3 to 5 to complete the entire title.
If you make a mistake
Press CURSOR← or → until the character you want to change flashes, then repeat steps 3 to 5.

To erase a character
Press CLEAR while the character is flashing. You cannot insert characters.

7 Press ENTER/YES to complete the labelling procedure.
The titles you labelled appear sequentially, and then the original display appears.

To cancel labelling

Press MENU/NO.

Notes

- You can label a track title during play. The playback repeats until you finish labelling.
- If the MD is record protected, “C11” and “Protected” appear alternately and the MD cannot be recorded. Remove the MD, then slide the record protection tab to the closed position (see page 25).

Copying a disc or track title

You can copy a labeled disc or track title to use it as a title of another track or the disc title within a disc.

- 1 Press MENU/NO in stop mode.
- 2 Press ◀◀ or ▶▶ repeatedly until “Name ?” appears, then press ENTER/YES.
- 3 Press ◀◀ or ▶▶ repeatedly until “Name Copy ?” appears, then press ENTER/YES.
- 4 Press ◀◀ or ▶▶ repeatedly to select “Disc” (when copying the disc title) or the track number with the title you want to copy, then press ENTER/YES.
- 5 Press ◀◀ or ▶▶ repeatedly to select the copy destination track number or “Disc” (when copying as the disc title), then press ENTER/YES.

To cancel copying

Press ■ for the MD.

Checking the titles

To check the disc titles, press SCROLL in stop mode. To check the track title, press SCROLL during play. The title appears scrolling in the display. To stop scrolling, press SCROLL. Press the button again to resume scrolling.

Erasing the titles

- 1 Press MENU/NO in stop mode.
- 2 Press ◀◀ or ▶▶ repeatedly until “Name ?” appears, then press ENTER/YES.
- 3 Press ◀◀ or ▶▶ repeatedly until “Name Erase?” appears, then press ENTER/YES.
To erase all the titles, press ◀◀ or ▶▶ repeatedly until “Name All Ers?” appears, then press ENTER/YES.
- 4 Press ◀◀ or ▶▶ repeatedly until the desired title to erase appears, then press ENTER/YES.
“Complete !!” appears and the title is erased.

To cancel erasing

Press MENU/NO.

To return to the condition before labelling or erasing

You can return to the original condition immediately after labelling or erasing a title (see page 44).

Erasing recordings

— Erase Function

The MD deck lets you erase unwanted tracks quickly and easily. You can restore the contents to the condition before erasing (unerase) by using the Undo function. Note, however, you cannot undo an edit after performing any additional edits.

The three options for erasing recordings are:

- Erasing a single track. (ERASE)
- Erasing all tracks. (ALL ERASE)
- Erasing a portion of a track. (A-B ERASE)

Erasing a single track

You can erase a track simply by selecting its track number. When you erase a track, the total number of tracks on the MD decreases by one and all the tracks following the erased one are renumbered.

Eg.: Erasing track 2.

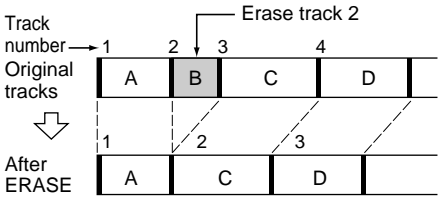

When erasing multiple tracks, you should proceed in order from high to low track number to prevent the renumbering of tracks that have not been erased yet.

continued

Erasing recordings (continued)

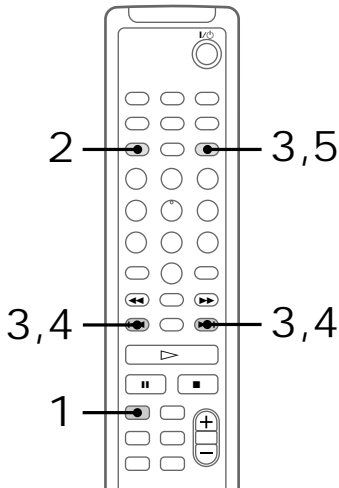

1 Press MD to switch the function to MD.

2 Press MENU/NO to display “Edit Menu”.

3 Press ◀◀ or ▶▶ repeatedly until “Track Erase ?” appears, then press ENTER/YES.

4 Press ◀◀ or ▶▶ repeatedly until the desired track number appears.

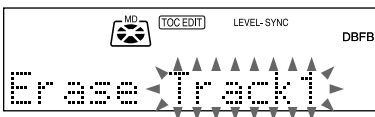

5 Press ENTER/YES.
“Complete !!” appears for a few seconds and the selected track and title are erased.

To cancel erasing

Press MENU/NO.

Note

“Erase???” appears when the track was recorded or edited on another deck and is protected. To erase the track, press ENTER/YES while “Erase???” appears.

Erasing all tracks

You can erase the disc title, all recorded tracks and their titles at once.

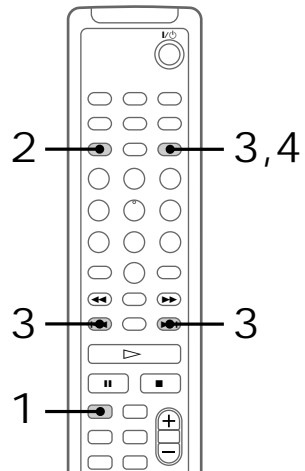

1 Press MD to switch the function to MD.

2 Press MENU/NO to display “Edit Menu”.

3 Press ◀◀ or ▶▶ repeatedly until “All Erase ?” appears, then press ENTER/YES.
“All Erase ?” appears.

4 Press ENTER/YES again.
“Complete !!” appears for a few seconds and the disc title, all recorded tracks and their titles are erased.

To cancel erasing

Press MENU/NO.

Erasing a portion of a track (A-B Erase Function)

You can specify a portion within a track and erase the portion with ease. You can shift the desired portion by frame*, minute or second intervals. This function is convenient when erasing unnecessary sections after recording a satellite broadcast or FM broadcast.

* 1 frame is 1/86 second.

E.g.: Erasing a portion of track 2.

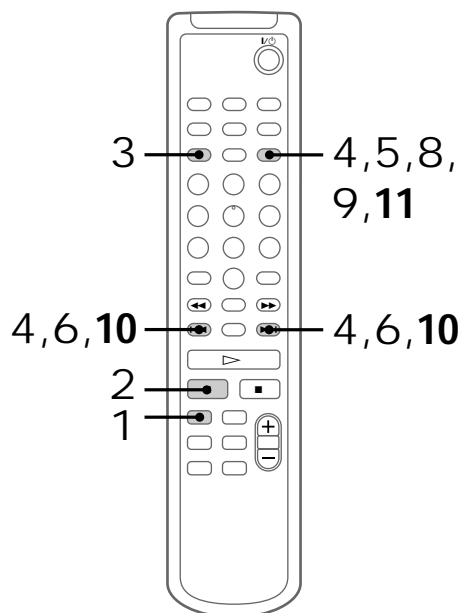
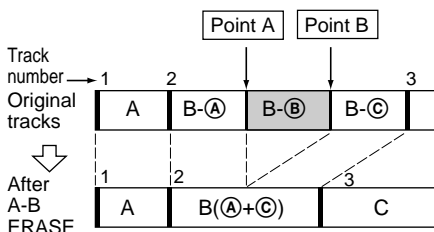

- 1 Press MD to switch the function to MD.

- 2 While playing an MD, press **II** at the starting point of the portion to be erased (point A).
The MD pauses.

- 3 Press MENU/NO to display “Edit Menu”.

- 4 Press **◀◀** or **▶▶** repeatedly until “A-B Erase ?” appears, then press ENTER/YES.

- 5 Press ENTER/YES again.
“—Rehearsal—” and “Point A ok?” appear alternately while the deck plays the selected track from the beginning to point A.

- 6 While monitoring the sound, press **◀◀** or **▶▶** repeatedly to find the starting point of the portion to be erased (point A).

You can shift the starting point by 1/86 second (1 frame) intervals.

To shift the point by second or minute intervals, press **◀◀** or **▶▶** so that “s” or “m” flashes, then press **◀◀** or **▶▶**.

- 7 Repeat step 6 until point A is played correctly.

continued

8 Press ENTER/YES if point A is correct. “Point B Set” appears and playback for setting the ending point of the portion to be erased (point B) starts.

9 Continue playback until the deck reaches point B, then press ENTER/YES. “A-B Ers” and “Point B ok?” appear alternately and the deck repeats a portion of the few seconds before point A and after point B successively.

10 Press ◀◀ or ▶▶ repeatedly to find point B. The procedure is the same as step 6.

11 Press ENTER/YES if point B is correct. “Complete !!” appears for a few seconds and the portion between point A and B is erased.

To cancel A-B Erase

Press MENU/NO.

Note

If “Impossible” appears, the specified portion cannot be erased. This happens when you have edited the same track many times. This is due to a technical limitation of the MD system and is not a mechanical error.

Moving recorded tracks

— Move Function

You can use this function to change the order of any track on the disc. When you move tracks, the tracks are automatically renumbered.

E.g.: Moving track 3 to position 2.

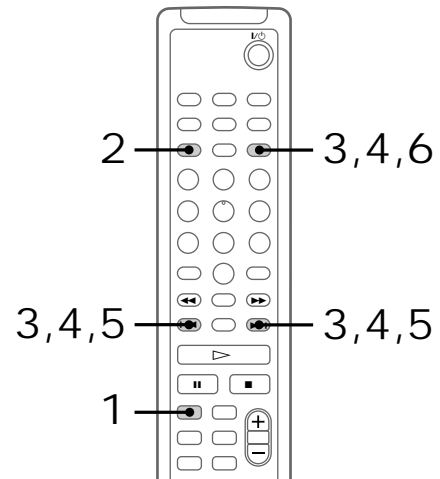
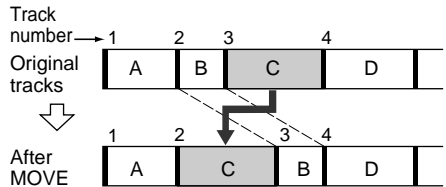

1 Press MD to switch the function to MD.

2 Press MENU/NO to display “Edit Menu”.

3 Press ◀◀ or ▶▶ repeatedly until “Move ?” appears, then press ENTER/YES.

4 Press **⏮** or **⏭** repeatedly until the desired track number to move appears, then press ENTER/YES.

5 Press **⏮** or **⏭** repeatedly until the new track position appears.

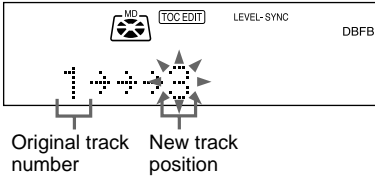

6 Press ENTER/YES.
 “Complete !!” appears for a few seconds and the selected track moves to the appointed position.

To cancel moving
 Press MENU/NO.

To return to the track order
 before MOVE

You can return to the original track order immediately after moving recorded tracks (see page 44).

Dividing recorded tracks

— Divide Function

You can use this function to mark track numbers after recording. The total number of tracks increases by one and all the tracks following the divided ones are renumbered.

E.g.: Dividing track 2 into two tracks.

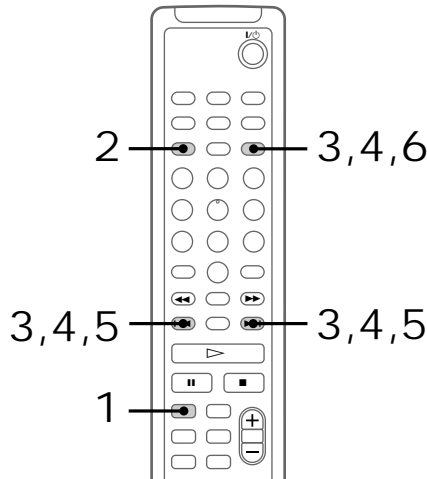
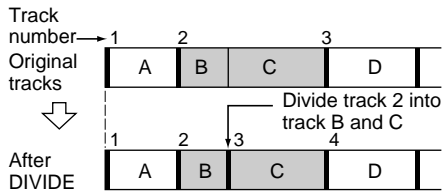

1 Press MD to switch the function to MD.

2 Press MENU/NO to display “Edit Menu”.

3 Press **⏮** or **⏭** repeatedly until “Divide ?” appears, then press ENTER/YES.

continued

Dividing recorded tracks (continued)

4 Press **◀◀** or **▶▶** repeatedly until the desired track number to divide appears, then press **ENTER/YES**.

“—Rehearsal—” appears and the portion to be divided is played repeatedly.

5 While monitoring the sound, press **◀◀** or **▶▶** repeatedly to adjust the point to be divided.

You can shift the point by 1/86 second (1 frame) intervals.

To shift the point by second or minute intervals, press **◀◀** or **▶▶** so that “s” or “m” flashes, then press **◀◀** or **▶▶**.

6 Press **ENTER/YES**.

“Complete !!” appears for a few seconds and the newly created track starts playing.

To cancel dividing

Press **MENU/NO**.

To return to the condition before DIVIDE

You can return to the original condition immediately after dividing the tracks (see page 44). You can also return to the original condition by using the Combine Function (see this page).

Notes

- If you divide a labelled track (page 36) into two tracks, only the first track retains the track title.

E.g.:

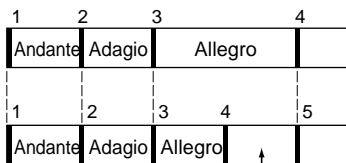

- “Impossible” appears, when you specify the division point at the beginning or end of a track. Press **◀◀** or **▶▶** to shift the position.

Combining recorded tracks — Combine Function

You can use this function to combine 2 tracks into a single track. The total number of tracks decreases by one and all tracks following the combined ones are renumbered.

E.g.: Combining track 3 to track 1.

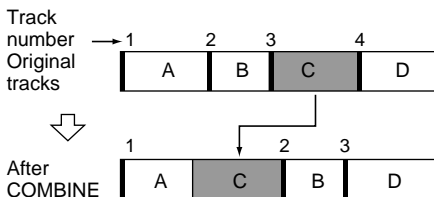

E.g.: Combining track 1 to track 4.

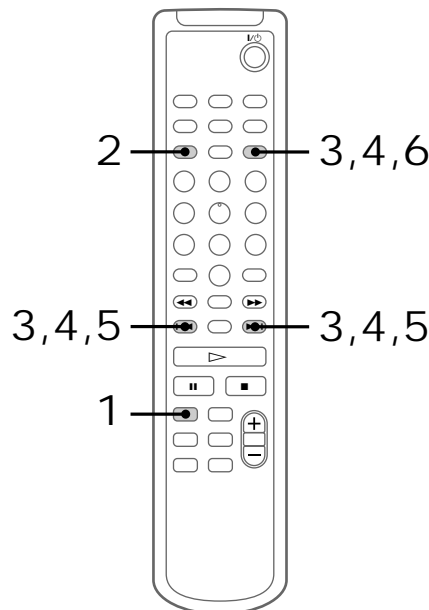
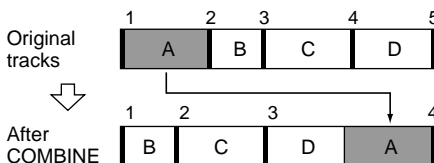

1 Press MD to switch the function to MD.

2 Press MENU/NO to display “Edit Menu”.

3 Press ◀◀ or ▶▶ repeatedly until “Combine ?” appears, then press ENTER/YES.

4 Press ◀◀ or ▶▶ repeatedly until the first track number of the two to be combined appears, then press ENTER/YES.

For example, to combine tracks 4 and 1, select 4.

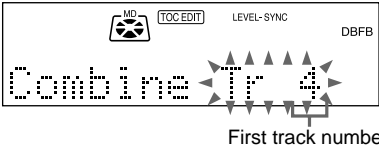

5 Press ◀◀ or ▶▶ repeatedly until the second track number of the two to be combined appears.

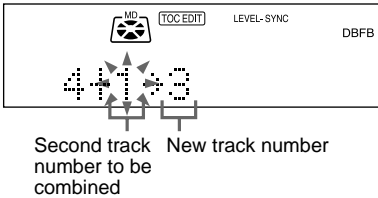

6 Press ENTER/YES.
“Complete !!” appears for a few seconds and the tracks are combined. Play starts.

To cancel combining
Press MENU/NO.

To return to the condition before
COMBINE

You can return to the original condition immediately after combining the tracks (see the next page). You can also return to the original condition by using the Divide function.

Notes

- If both of the combined tracks have track titles, the title of the second track is erased.
- If “Impossible” appears, the tracks cannot be combined. This happens when you have edited the same track many times. This is due to a technical limitation of the MD system and is not a mechanical error.

Undoing the last edit

— Undo Function

You can use this function to cancel the last edit and restore the contents of the MD to the condition before the edit.

Note, however, that you cannot undo an edit if you do any of the following after the edit:

- Do another edit.
- Press the ● REC or CD-MD SYNC button.
- Update the TOC by turning off the system or ejecting the MD.
- Disconnect the mains lead.

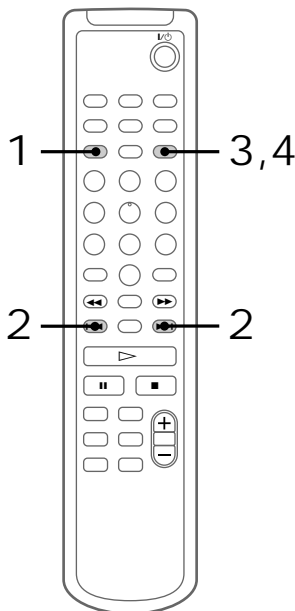

1 Press MENU/NO in stop mode to display “Edit Menu”.

2 Press ◀◀ or ▶▶ repeatedly until “Undo ?” appears.

“Undo ?” does not appear, when there is no editing function that can be cancelled.

3 Press ENTER/YES.

One of the following messages appears, depending on the last edit.

Editing done	Message
Labelling a track or an MD	“Name Undo?”
Erasing labelled titles	
Erasing a single track	
Erasing all tracks	“Erase Undo?”
Erasing a portion of a track	
Moving a track	“Move Undo?”
Dividing a track	“Divide Undo?”
Combining tracks	“Combine Undo?”

4 Press ENTER/YES again.

“Complete !!” appears for a few seconds and the contents of the MD are restored to the condition before the edit.

To cancel Undo function

Press MENU/NO.

Reinforcing the bass sound — DBFB

You can listen to music with stronger bass tones or a more powerful sound.

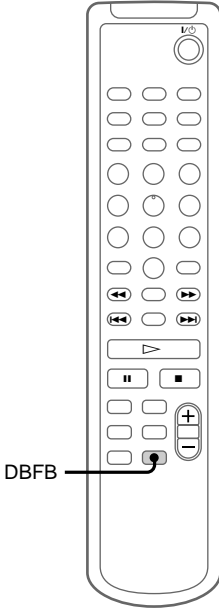

- ➔ Press DBFB*.
“DBFB” appears in the display.
Press again to cancel DBFB.

* DBFB: Dynamic Bass Feedback

Tip
DBFB is factory set to on.

Selecting the Preset Equalizer menu

The Preset Equalizer enables you to select the sound characteristic among 5 sound effects according to the type of music you are listening to.

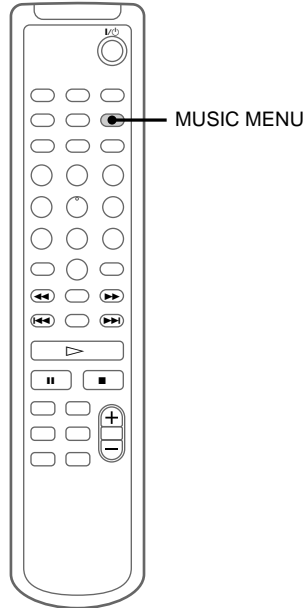

- ➔ Press MUSIC MENU repeatedly.
Each time you press the button, the display changes as follows:

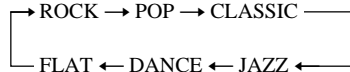

To cancel the Preset Equalizer
Press MUSIC MENU repeatedly until “FLAT” appears.

Tips

- The Preset Equalizer menu is factory set to “ROCK.”
- The Preset Equalizer effect is not recorded on an MD or a tape.

Labelling the preset stations — Station Name

You can label each preset station with up to 12 characters (Station Name). The Station Name appears when you tune in the station.

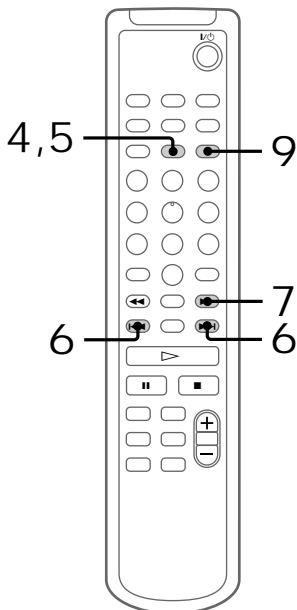
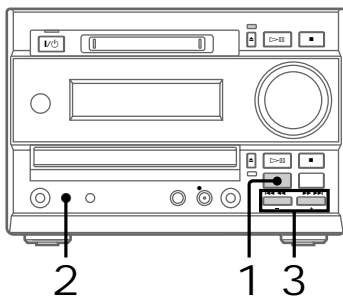

- 1 Press TUNER/BAND to select “FM” or “AM”.

- 2 Press TUNING MODE repeatedly until “PRESET” appears.

- 3 Press TUNING + or – repeatedly until the desired preset station to label appears.

- 4 Press NAME EDIT on the remote. The text input screen appears, and the cursor flashes.

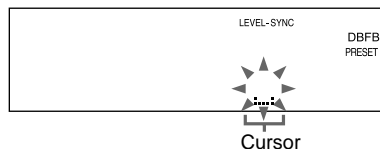

- 5 Press CHARACTER on the remote repeatedly to select the desired type of character.

Each time you press the button, the display changes as follow:

□ (Blank space) → A (Upper cases) → a (Lower cases) → 0 (Numbers) → ! (Symbols) → □ (Blank space) → ...

- 6 Press ◀◀ or ▶▶ on the remote repeatedly to select the desired character.

To enter a blank space
Press CURSOR→ without pressing ◀◀ or ▶▶.

To enter a symbol
You can use the following 24 symbols.

!"#\$%&'()*+,-./:;<=>?@_`

- 7 Press CURSOR→ on the remote.

The character you selected in step 6 stops flashing and the cursor shifts to the right.

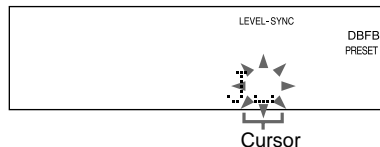

-
- 8 Repeat steps 5 to 7 to complete the entire title.

If you make a mistake

Press CURSOR← or → until the character you want to change flashes, then repeat steps 5 to 7.

To erase a character

Press CLEAR on the remote while the character is flashing. You cannot insert characters.

- 9 Press ENTER/YES on the remote to complete the labelling procedure.
-

To cancel labelling

Press MENU/NO on the remote.

To check the Preset number and frequency

The station name appears when you tuned the labelled station.

To check the preset number and frequency, press DISPLAY on the remote. The preset number and frequency are displayed for 4 seconds and it returns to the station name display.

To erase the name

- 1 Repeat steps 1 to 4.
- 2 Press CLEAR on the remote repeatedly to erase the name.
- 3 Press ENTER/YES on the remote.

Using the Radio Data System (RDS)

(European model only)

What is the Radio Data System?

Radio Data System (RDS) is a broadcasting service that allows radio stations to send additional information along with the regular programme signal. RDS is available only on FM stations*.

Note

RDS may not work properly if the station you are tuned in is not transmitting the RDS signal properly or if the signal is weak.

* Not all FM stations provide RDS service, nor do they provide the same types of services. If you are not familiar with the RDS system, check with your local radio stations for details on RDS services in your area.

Receiving RDS broadcasts

- ➔ Simply select a station from the FM band.

When you tune in a station that provides RDS services, the station name appears in the display.

To check the RDS information

Each time you press DISPLAY, the display changes as follows:

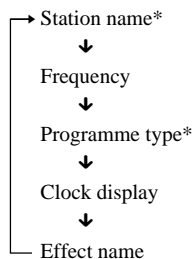

* If the RDS broadcast is not received, the station name and programme type may not appear in the display.

Falling asleep to music

— Sleep Timer

You can set the system to turn off after a certain time, so that you can fall asleep to music. You can preset the time to turn off in 10 minutes increments.

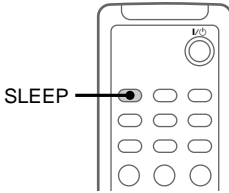

➔ Press SLEEP.

Each time you press the button, the minute display (the turn-off time) changes as follows:

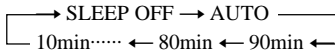

If you select "AUTO"

The system turns off after 100 minutes.
The system also turns off automatically when the current CD or MD finishes playing.

To check the remaining time

Press SLEEP once.

To change the time to turn off

Select the time you want by pressing SLEEP.

To cancel the Sleep Timer function

Press SLEEP repeatedly until "SLEEP OFF" appears.

Tip

You can use the Sleep Timer, even if you have not set the clock.

Note

Do not set to "AUTO" during CD-MD Synchro Recording.

Waking up to music

— Daily Timer

You can wake up to music at a preset time. Make sure you have set the clock (see page 6).

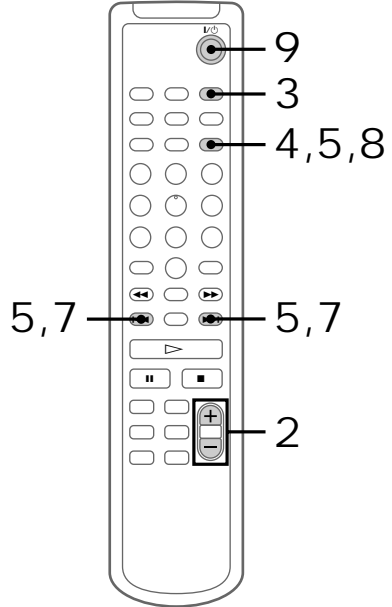

- 1 Prepare the sound source you want to play.
 - CD: Place a CD. To start from a specific track, make a programme (see page 17).
 - MD: Insert an MD. To start from a specific track, make a programme (see page 22).
 - Radio: Tune in a station (see page 7).
 - Tape: Insert a tape in the optional tape deck TC-TX373.
- 2 Press VOLUME +/- to adjust the volume.
- 3 Press CLOCK/TIMER SET.
"SET DAILY" appears.

4 Press ENTER/YES.
“ON” lights up, and the hour indication flashes.

5 Set the time to start play.
Press ◀◀ or ▶▶ repeatedly to set the hour, then press ENTER/YES.
The minute indication flashes.

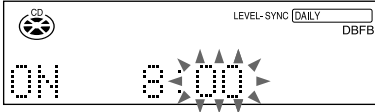

Press ◀◀ or ▶▶ repeatedly to set the minute, then press ENTER/YES.
The hour indication flashes again.

6 Set the time to stop play following the above procedure.

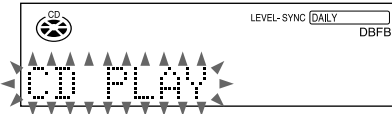

7 Press ◀◀ or ▶▶ repeatedly to select the desired sound source.
The indication changes as follows:

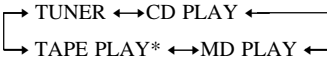

* Select this to use another component (the optional tape deck TC-TX373) as the sound source.

8 Press ENTER/YES.
The start time, the stop time, and the sound source appear in turn, before the original display returns.

9 Press I/⏻ to turn off the system.

To change the setting
Start over from step 1.

To check the setting / activate the timer

Press CLOCK/TIMER SELECT, then press ◀◀ or ▶▶ until “SET DAILY” appears. Then, press ENTER/YES.

To cancel the timer

Press CLOCK/TIMER SELECT, then press ◀◀ or ▶▶ repeatedly until “TIMER OFF” appears. Then press ENTER/YES.

Tip

When you connect the optional tape deck TC-TX373 to the system, you can activate the tape deck using the Daily Timer function without setting the timer on the tape deck.

Notes

- You cannot activate Daily Timer and recording timer at the same time.
- Do not operate the system from the time the system turns on until the play starts (about 30 seconds before the preset time).
- If the system is on at the preset time, the set sound source starts playing.
- If you use another component (except for the optional tape deck TC-TX373), you must set the timer on both systems to the same time.
- You cannot use the components connected to the DIGITAL OPTICAL IN jack or LINE IN jack as the sound source for Daily Timer.

Timer recording radio programmes

To timer record, you must first preset the radio station (see page 7) and set the clock (see page 6).

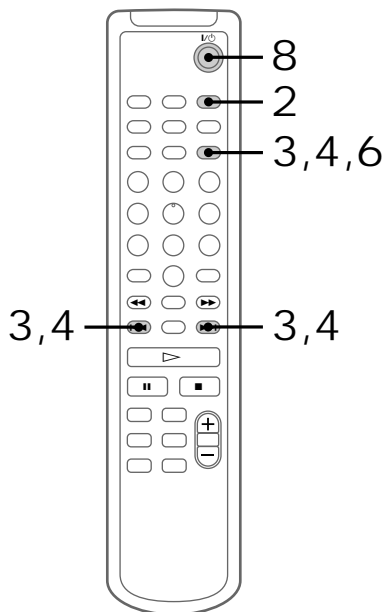

- 1 Tune in the preset radio station (see page 13).
- 2 Press **CLOCK/TIMER SET**.
“SET DAILY” appears.
- 3 Press **◀▶** or **▶▶** to select either “MD REC” or “TAPE REC”, then press **ENTER/YES**.
“ON” lights up and the hour indication flashes.

- 4 Set the time to start recording.
Press **◀▶** or **▶▶** repeatedly to set the hour, then press **ENTER/YES**.
The minute indication flashes.

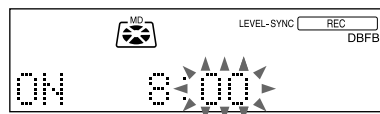

Press **◀▶** or **▶▶** repeatedly to set the minute, then press **ENTER/YES**.

- 5 Set the time to stop recording following the procedure in step 4.
- 6 When you record onto an MD, select **STEREO** or **MONO** by pressing **◀▶** or **▶▶**, then press **ENTER/YES**.
The timer recording settings appear, then the original display returns.
- 7 Insert a recordable MD or tape.
If you use a partially recorded MD, recording starts after the recorded tracks.
- 8 Press **I/⏻** to turn off the system.

To change the setting

Start over from step 1.

To check the setting / To use the timer

- 1 Press CLOCK/TIMER SELECT.
- 2 Press **◀◀** or **▶▶** to select either “MD REC” or “TAPE REC”, then press ENTER/YES.

To cancel the timer

Press CLOCK/TIMER SELECT and press **◀◀** or **▶▶** repeatedly until “TIMER OFF” appears, then press ENTER/YES.

Tip

When you record from the radio, the station name (see page 46, or frequency when the station is not labelled), the start time and the stop time are automatically recorded on the MD.

Notes

- The Smart Space and Level Synchro Recording functions do not operate.
- You cannot activate Daily Timer and the recording timer at the same time.
- Do not operate the system from the time the system turns on until the recording starts (about 30 seconds before the preset time).
- When you record on a brand new MD, the first 15 seconds are not recorded.
- If the system is on about 30 seconds before the preset time, the timer-recording will not be activated.
- The volume is reduced to minimum during recording.
- When the timer is set, the Power Saving Mode does not function.
- If you use another component (except for the optional tape deck TC-TX373), you must set the timer on both systems to the same time. You cannot activate the component with this system’s timer.

Connecting optional A/V components

To enhance your system, you can connect optional components. Refer to the operating instructions of each component.

Connecting the audio cords (not supplied)

When using audio cords (not supplied) to connect other A/V components to the system, make sure to insert the plugs firmly, pushing them in all the way. No sound will be produced if the plugs are not inserted securely.

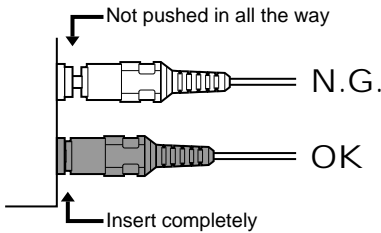

Connecting a portable MD, etc.

Connect a portable MD, etc., to the LINE IN jack on the front panel of the unit, using an audio connecting cord (not supplied).

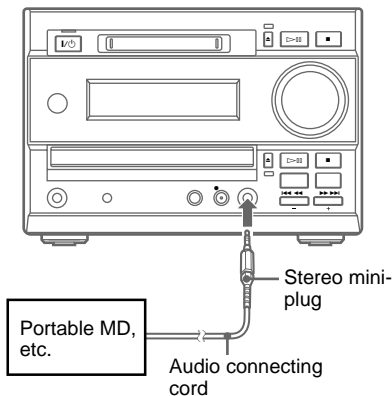

Connecting the optional TC-TX373 tape deck

CD Synchro Recording and Timer Recording are possible when the TAPE CONTROL jacks are connected.

Refer to the operating instructions included with the TC-TX373 tape deck for details.

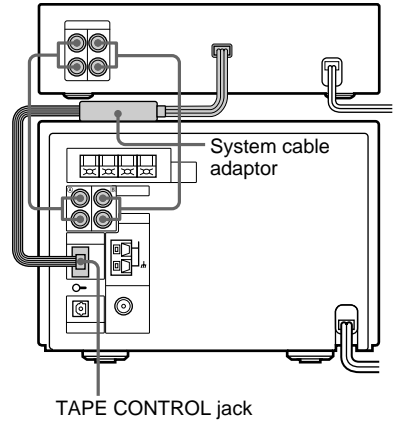

Tip

The **A** and **B** markings of the TAPE IN/OUT jacks guide you to connect the optional TC-TX373 tape deck.

Connecting another tape deck

Connect a tape deck to the TAPE IN and OUT jacks on the rear panel of the unit, using audio connecting cords (not supplied).

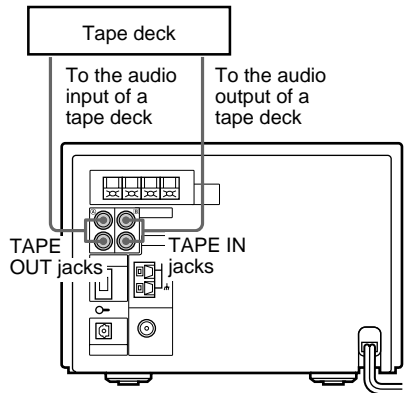

Connecting a CS/BS digital tuner, etc.

Connect the component to the DIGITAL OPTICAL IN jack on the rear panel of the unit, using a digital connecting cable (square, not supplied).

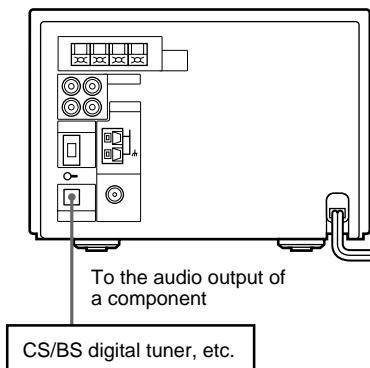

Connecting external aerials

Connect an outdoor aerial to improve reception.

FM aerial

Connect an commercially available FM outdoor aerial, or you can use a TV aerial instead.

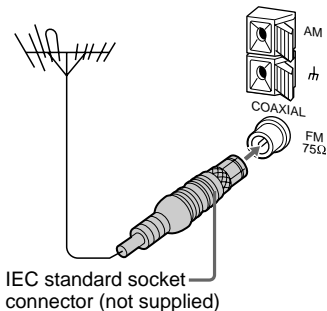

AM aerial

Connect a 6- to 15- meter insulated wire to the AM aerial terminal. Leave the supplied AM loop aerial connected.

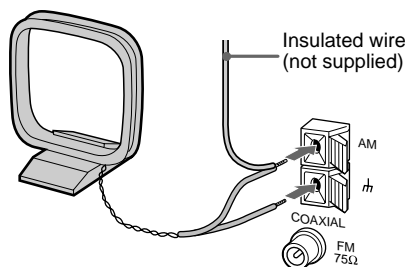

Important

If you connect an outdoor antenna, connect a ground wire to the h terminal. To prevent a gas explosion, do not connect the ground wire to a gas pipe.

Precautions

On operating voltage

- Before operating the system, check that the operating voltage of your system is identical with the voltage of your local power supply.
- The voltage selector is located at the bottom of the apparatus.

On safety

- The unit is not disconnected from the AC power source (mains) as long as it is connected to the wall outlet, even if the unit itself has been turned off.
- Unplug the system from the mains if it is not to be used for an extended period of time. To disconnect the mains lead, pull it out by the plug. Never pull the cord itself.
- Should any solid object or liquid fall into the system, unplug the system and have it checked by qualified personnel before operating it any further.
- AC power cord (mains lead) must be changed only at the qualified service shop.
- When you connect the mains lead to the mains, even if the power is off, the system begins charging for remote and timer functions. Therefore the surface of this unit become warm, this is normal.

On placement

- Make sure the system fan is on during use. Place the system in a location with adequate air circulation, and do not place anything on top of the system.
- Place the system in a location with adequate ventilation to prevent heat build up.
- Do not place the system in an inclined position.
- Do not place the system in locations where it is;
 - Extremely hot or cold
 - Dusty or dirty
 - Very humid
 - Subject to vibrations
 - Subject to direct sunlight.

On installing

When you move the system, remove the CD or MD.

On operation

- If the system is brought directly from a cold to a warm location, or is placed in a very damp room, moisture may condense on the lens inside the CD player or the MD deck. Should this occur, the system will not operate properly. Remove the CD or MD and leave the system turned on for about an hour until the moisture evaporates.
- When you move the system, take out any discs.

If you have any questions or problems concerning your system, please consult your nearest Sony dealer.

On the speaker system

This speaker system is not magnetically shielded and the picture on TV sets may become magnetically distorted. In such a case, turn off the power of the TV set once, and after 15 to 30 minutes turn it on again.

If there seems to be no improvement, locate the speaker system further away from the TV set. Also, be sure not to place objects in which magnets are attached or used near the TV set, such as audio racks, TV stands, and toys. These may cause magnetic distortion to the picture due to their interaction with the system.

Notes on MDs

- If you try to force the shutter open, the disc may be damaged. If the shutter opens, close it immediately without touching the disc inside.
- Affix the label supplied with the disc only to the specified label indentation. Do not affix the label around the shutter or in other locations. Note that the shape of the indentation depends on the disc.

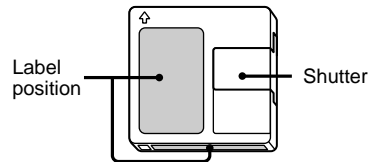

- Wipe the disc cartridge with a dry cloth to remove dirt.
- Do not expose the MD to direct sunlight or heat sources such as hot air ducts, nor leave it in a car parked in direct sunlight.

Notes on CDs

- Before playing, clean the CD with a cleaning cloth. Wipe the CD from the centre out.
- Do not use a CD with tape, seals, or paste on it as this may damage the player.
- Do not use solvents such as benzine, thinner, commercially available cleaners, or antistatic spray intended for vinyl LPs.
- Do not expose the CD to direct sunlight or heat sources such as hot air ducts, nor leave it in a car parked in direct sunlight.

Cleaning the cabinet

Use a soft cloth slightly moistened with mild detergent solution.

System limitations of MDs

The recording system in your MD deck has the limitations described below.

Note, however, that these limitations are due to the inherent nature of the MD recording system itself, not to mechanical causes.

“Disc Full!!!” appears before the MD has reached the maximum recording time

When 255 tracks have been recorded on the MD, “Disc Full!!!” appears regardless of the total recorded time. More than 255 tracks cannot be recorded on the MD. To continue recording, erase unnecessary tracks or use another recordable MD.

“Disc Full!!!” appears before the maximum number of tracks (255) is reached

Fluctuations in emphasis within tracks are sometimes interpreted as track intervals, increasing the track count and causing “Disc Full!!!” to appear.

The remaining recording time does not increase even after erasing numerous short tracks

Tracks shorter than 12 seconds are not counted, so erasing them may not increase the recording time.

Some tracks cannot be combined with others

Track combination may become impossible when tracks are shorter than 8 seconds.

The total recorded time and the remaining time on the MD do not add up to the maximum recording time

Recording is done in minimum units of 2 seconds each, no matter how short the material. The recorded contents may be shorter than the maximum recording capacity. Disc space may also be reduced by scratches.

The sound may drop-out while searching the edited tracks

Tracks created through editing may exhibit sound dropout during searching because high-speed playback requires time to search for the position on the disc when the tracks are not in order.

Track numbers cannot be marked

When “LEVEL-SYNC” (page 30) lights up in the display window during analogue recording, the track numbers may not be marked at the beginning of the track:

- if the input signal is below a certain fixed level for less than two seconds between tracks.
- if the input signal is below a certain fixed level for more than two seconds in the middle of the track.

Guide to the Serial Copy Management System

Digital audio components, such as CDs, MDs, and DATs let you copy music easily with high quality by processing music as a digital signal.

To protect the copyrighted music programmes, this system uses the Serial Copy Management System that allows you to make only a single copy of a digitally recorded source through digital-to-digital connections.

You can make only a first generation copy* through a digital-to-digital connection.

For example:

- 1 You can make a copy of a commercially available digital sound programme (for example, a CD or MD), but you cannot make a second copy from the first-generation copy.
 - 2 You can make a copy of a digital signal from a digitally recorded analogue sound programme (for example, an analogue record or a music cassette tape) or from a digital satellite broadcast programme, but you cannot make a second copy.
- * A first-generation copy means a digital recording of a digital signal made on digital audio equipment. For example, if you record from this system’s CD player to the MD deck, you make a first-generation copy.

Note

This copy management system doesn’t apply when you make a recording through analogue-to-analogue connections.

Troubleshooting

If you have any problem using this system, use the following checklist.

First, check that the mains lead is connected firmly and that the speakers are connected correctly and firmly.

Should any problem persist, consult your nearest Sony dealer.

General

There is no sound.

- Turn VOLUME clockwise.
- Make sure the headphones are not connected.
- Check the speaker connections (see page 4).

Sound comes from one channel, or unbalanced left and right volume.

- Connect the speaker cords properly (see page 4).
- Place the speakers as symmetrically as possible.
- Connect only one of the supplied speakers to each set of speaker terminals.
- Connect the supplied speakers.

There is severe hum or noise.

- Move the system away from the source of noise.
- Connect the system to a different mains outlet.
- Install a noise filter (commercially available) to the mains line.

“0:00” (for the European model) or “12:00 AM” (for other models) flashes in the display.

- Set the clock again (see page 6).

The timer cannot be set.

- Set the clock again (see page 6).

The timer does not function.

- Press CLOCK/TIMER SELECT to set the timer and light up “DAILY” or “REC” in the display (see pages 49 and 51).
- Check the set contents and set the correct time (see pages 48 – 51).
- Connect the system cable adapter to the optional TC-TX373 tape deck properly (see page 52).
- Refer to the operating instructions included with the connected component, and set the timer to the same time as the system’s timer.

The remote does not function.

- Remove the obstacle.
- Move the remote closer to the system.
- Point the remote at the system’s sensor.
- Replace the batteries (R6/size AA).
- Locate the system away from the fluorescent light.

“PROTECT” and “PUSH POWER” appear alternately.

- Press I/⏻ (power) to turn off the system. Turn on the system again after a while.

CD Player

The CD tray does not close.

- Place the CD correctly in the centre of the tray.
- Always close the tray by pressing CD ▲. Trying to press the tray closed with your fingers may cause problems with the CD player.

The CD does not eject.

- Consult your nearest Sony dealer.

Play does not start.

- Open the CD tray and check whether a CD is loaded.
- Wipe the CD clean (see page 54).
- Replace the CD.
- Place the CD correctly in the centre of the tray.
- Place the CD in the tray with the label side up.
- Remove the CD and wipe away the moisture on the CD, then leave the system turned on for a few hours until the moisture evaporates.
- Press CD ▷▶▶ to start play.

The sound skips.

- Wipe the CD clean (see page 54).
- Replace the CD.
- Try moving the system to a place without vibration (e.g., on top of a stable stand).
- Try moving the speakers away from the system, or placing them on separate stands. When you listen to a track with bass sounds at high volume, the speaker vibration may cause the sound to skip.

Play does not start from the first track.

- Press PLAY MODE repeatedly until “PGM” or “SHUFFLE” disappears to return to normal play.

“—OVER—” appears.

- Keep pressing MD/CD ◀◀◀◀ to return to the desired playing position.

MD Deck

An MD cannot be inserted.

- Insert the MD with the arrow side up and the arrow pointing toward the deck.

The controls do not work.

- Replace the MD with a new one.
- Retry the operations after “TOC” turns off.

Play does not start.

- Replace the MD.
- Insert the MD and leave the system turned on for a few hours until the moisture evaporates.
- Press MD ▷▶▶ to start play.

The sound skips.

- Replace the MD.
- Try moving the system to a place without vibration (e.g., on top of a stable stand).
- Try moving the speakers away from the system, or placing them on separate stands.
When you listen to a track with bass sounds at high volume, the speaker vibration may cause the sound to skip.
- Insert the disc and wait for 10 to 20 minutes with the system turned on.

Play does not start from the first track.

- Press PLAY MODE repeatedly until “PGM” or “SHUFFLE” disappears to return to normal play.

“—OVER—” appears.

- Keep pressing MD/CD ◀◀◀◀ to return to the desired playing position.

“OVER” lights red during recording.

- Set the volume of the connected component lower.

Recording or editing was done, but the TOC is not updated.

- MD recording and editing contents are recorded to the MD when the MD is removed, so make sure you remove the MD after recording or editing (see pages 25 and 35).

Recording is not possible.

- Remove the MD and slide the tab to close the slot (see page 25).
- Connect the optional A/V component properly (see pages 52 and 53).
- Switch to another sound source.
- Replace the MD with a recordable MD, or use the Erase Function to erase unnecessary tracks (see pages 37 – 40).
- Start recording over from the beginning.

The sound from an MD you recorded is too low (or too high).

- Readjust the recording level (see page 33).

Optional components

There is no sound.

- Refer to General item “There is no sound.” on page 56 and check the condition of the system.
- Connect the component properly (see pages 52 and 53) while checking:
 - if the cords/cables are connected properly.
 - if the cord/cable connectors are firmly inserted all the way.
- Turn on the connected component.
- Refer to the operating instructions included with the connected component and start playing.

The sound is distorted.

- Adjust the recording level (see page 33).

The sound from the component connected to the DIGITAL OPTICAL IN jack is not heard.

- Press FUNCTION repeatedly until “OPTICAL IN” appears.

continued

Tuner

Severe hum or noise/stations cannot be received.

- Set the proper band and frequency (see page 7).
- Connect the aerial properly (see page 4).
- Find a place and an orientation that provide good reception, then set up the aerial again. If you cannot obtain good reception, we recommend you connect a commercially available external aerial.
- The supplied FM lead aerial receives signals along its entire length, so make sure you extend it fully.
- Locate the aerials as far away from the speaker cords as possible.
- Consult your nearest Sony dealer if the supplied AM aerial has come off the plastic stand.
- Try turning off surrounding electrical equipments.

A stereo FM program cannot be received in stereo.

- Press STEREO/MONO until “STEREO” appears in the display.
- See “Severe hum or noise/stations cannot be received.”, and check the aerial condition.

Cyclical static noise is heard while recording on an MD.

- Adjust the aerial orientation and position until the noise stops.

If the system still does not operate properly after performing the above measures, reset the system as follows:

Press the RESET switch on the rear panel using a ball point pen etc.

The system is reset to the factory settings. All the settings you made such as the preset stations, clock, timer and CD disc titles are cleared and must be set again.

Self-diagnosis Display

This system has a Self-diagnosis display function to let you know if there is a system malfunction. The display shows a code made up of three letters and a message alternately to show you the problem. To solve the problem refer to the following list. If any problem persists, consult your nearest Sony dealer.

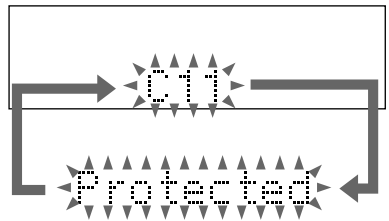

C11/Protected

The MD is protected against erasure.

- Remove the MD and slide the tab to close the slot (page 25).

C12/Cannot Copy

You tried to record a CD or MD with a format that the system does not support, such as a CD-ROM.

- Remove the disc and turn off the system once, then turn it on again.

C13/REC Error

Recording could not be performed properly.

- Move the system to a stable place, and start recording over from the beginning.

The MD is dirty or scratched, or the MD does not meet the standards.

- Replace the MD and start recording over from the beginning.

C13/Read Error

The MD deck cannot read the disc information properly.

- Remove the MD once, then insert it again.

C14/Toc Error

The MD deck cannot read the disc information properly.

- Replace the MD.

- Erase all the recorded contents of the MD using the All Erase function on page 38.

C41/CannotCopy

The sound source is a copy of a commercially available music software, or you tried to record a CD-R (Recordable CD).

→The Serial Copy Management System prevents making a digital copy (see page 55). You cannot record a CD-R.

C71/CheckOPT-IN

This appears momentarily because of the signal of the digital broadcast during recording.

→There is no affect on the recorded contents.

No component is connected to the DIGITAL OPTICAL IN jack, or a digital component is not connected properly.

→Connect a digital component to the DIGITAL OPTICAL IN jack properly using a digital connecting cable (not supplied, see page 53).

The connected digital component is not turned on.

→See the operating instructions supplied with the connected component and confirm whether the component is turned on.

The digital connecting cable connected to the DIGITAL OPTICAL IN jack is pulled out, or the connected digital component is turned off during digital recording.

→Connect the cable, or turn on the digital component.

CannotREC

- A pre-mastered MD is in the deck.
 - The function is switched to MD.
-

Complete!!

The editing operation of MDs is completed.

DiscFull!!

There is no time remaining on the MD.

Eject

The MD deck is ejecting the MD.

Impossible

- You tried to make an impossible editing operation.
 - You cannot combine the tracks due to the system limitations of MDs.
-

NameFull

There is no more space to store track or disc titles.

NoDisc

There is no disc in the MD deck.

NoName

You tried to show the title of a non-labelled disc or track.

—OVER—

You have reached the end of the MD while keep pressing MD/CD ►►►►I during playing pause.

PushSTOP!

You pressed PLAY MODE during play.

—Rehearsal—

The MD is playing the specified dividing point for confirmation during the Divide function.

SmartSpace

The signal was input again after silence continued for 3 or more but less than 30 seconds during digital recording.

continued

Messages

One of the following messages may appear or flash in the display during operation.

MD

AutoCut

The MD deck is pausing the recording because silence continued for 30 seconds or more during digital recording.

BlankDisc

The inserted recordable MD is new, or all tracks on the MD have been erased.

CannotEdit

- A pre-mastered MD is in the deck.
 - You tried to edit in Programme or Shuffle Play mode.
-

Self-diagnosis Display (continued)

Standby(flashing)

The timer settings have disappeared over time and are not available for saving to disc, or Program Play could not be activated since the program has disappeared over time.

TextProtect

There is CD TEXT information which cannot be recorded on the MD.

TOCReading

The MD deck is reading the TOC information of the MD.

TOCWriting

The MD deck is writing the information of recorded or edited contents.

TrackEnd

You have reached the end of the track while adjusting the dividing point during the Divide Function.

TUNER

CannotEdit

You tried to label or erase a non-preset station.

CD

NameFull

There are already 50 disc titles stored in the system.

—OVER—

You have reached the end of the CD while keeping pressing MD/CD ►►►► during pause.

Specifications

Main Unit (HCD-MD373)

Amplifier section

European model:

DIN power output (Rated): 25 + 25 watts (6 ohms at 1 kHz, DIN, 230 V)

Continuous RMS power output (Reference):

30 + 30 watts (6 ohms at 1 kHz, 10% THD, 230 V)

Music power output (Reference):

50 + 50 watts

Other models:

DIN power output (Rated): 20 + 20 watts (6 ohms at 1 kHz, DIN, 240 V)

18 + 18 watts (6 ohms at 1 kHz, DIN, 220 V)

Continuous RMS power output (Reference):

25 + 25 watts (6 ohms at 1 kHz, 10% THD, 240 V)

23 + 23 watts (6 ohms at 1 kHz, 10% THD, 220 V)

Peak Music Power Output: 400 watts

Inputs

TAPE IN (phono jacks): voltage 250 mV, impedance 47 kilohms

DIGITAL OPTICAL IN

LINE IN (stereo minijack):

voltage 250 mV, impedance 47 kilohms

Outputs

TAPE OUT (phono jacks): voltage 250 mV, impedance 1 kilohm

PHONES (stereo minijack):

accepts headphones of 8 ohms or more.

SPEAKER:

accepts impedance of 6 to 16 ohms.

CD player section

System

Compact disc and digital audio system

Laser

Semiconductor laser ($\lambda=780$ nm)

Emission duration: continuous

Laser output

Max. 44.6 μ W*

*This output is the value measured at a distance of 200 mm from the objective lens surface on the Optical Pick-up Block with a 7 mm aperture.

Frequency response

2 Hz – 20 kHz

MD deck section

System

MiniDisc digital audio system

Laser

Semiconductor laser ($\lambda=780$ nm)

Emission duration: continuous

Laser output

Max. 44.6 μ W*

*This output is the value measured at a distance of 200 mm from the objective lens surface on the Optical Pick-up Block with a 7 mm aperture.

Sampling frequency

44.1 kHz

Frequency response

5 Hz – 20 kHz

Tuner section

FM stereo, FM/AM superheterodyne tuner

FM tuner section

Tuning range

Tourist model: 76.0 – 108.0 MHz

Other models: 87.5 – 108.0 MHz
(50 kHz step)

Aerial FM lead aerial

Aerial terminals 75 ohms unbalanced

Intermediate frequency 10.7 MHz

AM tuner section

Tuning range

European model: 531 – 1,602 kHz

(with the interval set at 9 kHz)

Other models: 531 – 1,602 kHz
(with the interval set at 9 kHz)
530 – 1,710 kHz
(with the interval set at 10 kHz)

Aerial AM loop aerial

External aerial terminals

Intermediate frequency 450 kHz

Speaker (SS-CMD373)

Speaker system 2-way, bass-reflex type

Speaker units

Woofer: 13 cm dia., cone type

Tweeter: 2.5 cm dia., balanced drive type

Nominal impedance 6 ohms

General

Power requirements

European model: 230 V AC, 50/60 Hz

Other models: 110 – 120 V or 220 – 240 V
AC, 50/60 Hz

Power consumption

70 watts during normal operation

Approx. 3 watts in standby mode
(clock displayed)

Approx. 1 watt in standby mode
(clock not displayed)

Dimensions (w/h/d) incl. projecting parts and controls

Amplifier/Tuner/MD/CD section:

Approx. 215 × 150 × 330 mm

Speaker: Approx. 170 × 275 × 235 mm

Mass

Amplifier/Tuner/MD/CD section:

Approx. 6.2 kg

Speakers: Approx. 3.5 kg net per speaker

Supplied accessories

Remote (1)

R6 (size AA) batteries (2)

AM loop aerial (1)

FM lead aerial (1)

Speaker cords (2)

Design and specifications are subject to change without notice.

Parts descriptions for the remote

You can use the supplied remote to control the system.

Note

You cannot perform the following operations with the remote;

- TUNING MODE setting for the tuner
- STEREO/MONO setting for the tuner
- Removing discs
- Recording on the MD
- One Touch Play

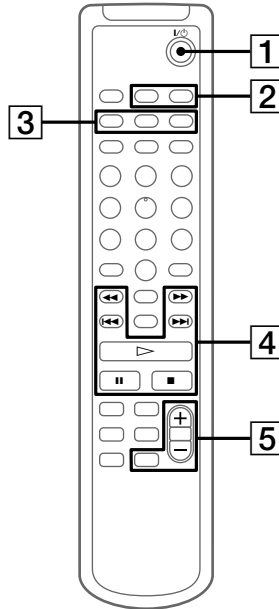

1 I/O (power) switch

2 CLOCK/TIMER SELECT button

Press to check timer settings, or to set the timer on/off. (pages 49 and 51)

CLOCK/TIMER SET button

Press to set the clock and timer functions. (pages 6, 48, 50)

continued

Parts descriptions for the remote (continued)

3 PLAY MODE button

Press to select normal play, Shuffle Play or Programme Play. (pages 16, 17, 22, 26)

REPEAT button

Press to play a track or all the tracks repeatedly (pages 16 and 21).

MUSIC MENU button

Press to select the type of the preset equalizer. (page 45)

4 CURSOR ←/→, ◀▶ buttons

Press to label a CD, MD and preset station, or to set the clock. (pages 6, 20, 36, 46)

◀◀/▶▶ (AMS: Automatic Music Sensor) buttons

▷ (play) button

⏸ (pause) button

■ (stop) button

5 VOLUME +/- buttons

Press to adjust the volume.

DBFB button

Press to reinforce the bass sound. (page 45)

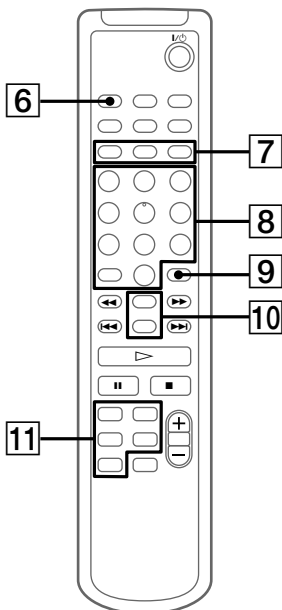

6 SLEEP button

Press to set Sleep Timer. (page 48)

7 MENU/NO button

Press to set Programme Play, or to label a CD, MD and preset station.

NAME EDIT, CHARACTER button

Press to display the text input screen and to select the type of characters to be input. (pages 20, 36, 46)

ENTER/YES button

Press to set the clock, Programme Play and to label a CD, MD and preset station, or to enter the settings in "Edit Menu" or "Setup Menu".

8 Number buttons

Press to select track numbers of a CD, MD, or preset station.

9 CLEAR button

Press to cancel the selection. (pages 17, 20, 23, 36, 47)

10 SCROLL button

Press to display the disc title or track title scrolling. (pages 20, 24, 37)

DISPLAY button

Press to show the various information. (pages 23 and 28)

11 The sound source buttons

MD button

CD button

FUNCTION button

Press to switch the sound source.

Each time you press this button, the sound source changes as follows;

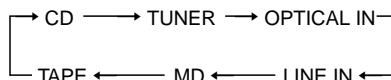

BAND, TUNER button

Press to select the tuner for the sound source, or to select the FM or AM band.

TAPE button

Index

A

- A-B Erase Function 39
- Adjusting
 - the operating voltage 5
 - the recording level 33
 - the sound 45
 - the volume 10, 13, 14
- Aerials 4
- After
 - editing 35
 - recording 25
- All Erase Function 38
- Analogue recording 25
- Auto Cut 31
- Automatic Source Selection 10, 13, 14
- Automatic tuning 14

B

- Batteries 5
- Before
 - editing 35
 - recording 25

C

- CD-MD Synchro Recording 11, 26
- CD TEXT information 18
- Clock setting 6
- Combine Function 42
- Connecting. *See* Hooking up

D

- Daily Timer 48
- DBFB 45
- Digital recording 25
- Disc Memo 19
- Display 18, 24
- Divide Function 41

E, F, G

- Erase Function 37
- Erasing
 - a portion of a track 39
 - a single track 37
 - a track number 42
 - all tracks on an MD 38

H, I, J, K

- Hooking up
 - optional components 52
 - the aerials 4
 - the mains 5
 - the speakers 4

L

- Labelling
 - a CD 19
 - a preset station 46
 - an MD 36
- Level Synchro Recording 30
- Listening to the radio 13

M

- Manual tuning 14
- Messages 59
- Move Function 40
- Music menu 45

N

- Name Function 36
- Normal Play 10, 12

O

- One Touch Play 10, 13, 14
- Optional equipments 52, 53

P, Q

- Playing
 - a CD 10, 16
 - an MD 12, 21
 - tracks in random order (Shuffle Play) 16, 22
 - tracks in the desired order (Programme Play) 17, 22
 - tracks repeatedly (Repeat Play) 16, 21
- Power Saving Mode 9
- Preset Equalizer menu 45
- Preset Tuning 13
- Presetting radio stations 7
- Programme Play 17, 22
- Protecting recordings 25

R

- Radio stations
 - presetting 7
 - tuning in 13, 14
- RDS 47
- Recording
 - a CD 11, 26
 - a radio programme 14
 - manual recording 27
 - monaural recording 34
 - on an MD 11, 25
 - timer recording 50
- Repeat Play 16, 21
- Resetting the system 58

S

- Saving recordings 25
- Self-diagnosis display 58
- Serial copy management system 55
- Setting the time 6
- Showing the time 9
- Shuffle Play 16, 22
- Sleep Timer 48
- Smart Space 31
- Sound adjustment 45
- Speakers 4
- Station Name 46
- System limitations 55

Index (continued)

T

- Time Machine Recording 28
- Timer
 - falling asleep to music 48
 - timer recording 50
 - waking up to music 48
- Track marking 30
- Track numbers 30
- Troubleshooting 56
- Tuning interval 8

U, V, W, X, Y, Z

- Undo Function 44