

Compact Hi-Fi Stereo System

Operating Instructions



Game SYNC

***LBT-GV8
LBT-GV6***

WARNING

To prevent fire or shock hazard, do not expose the unit to rain or moisture.

To avoid electrical shock, do not open the cabinet. Refer servicing to qualified personnel only.

Do not install the appliance in a confined space, such as a bookcase or built-in cabinet.

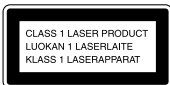

This appliance is classified as a CLASS 1 LASER product. The CLASS 1 LASER PRODUCT MARKING is located on the rear exterior.

To prevent fire, do not cover the ventilation of the apparatus with newspapers, table-cloths, curtains, etc. And don't place lighted candles on the apparatus.

To prevent fire or shock hazard, do not place objects filled with liquids, such as vases, on the apparatus.





Don't throw a battery, dispose it as the injurious wastes.

This stereo system is equipped with the Dolby B-type noise reduction system*.

* Manufactured under license from Dolby Laboratories.

"Dolby" and the double-D symbol are trademarks of Dolby Laboratories.

This system can play the following discs

	VIDEO CDs	Audio CDs
Disc logo		
Contents	Audio + Video (moving pictures)	Audio
Disc size	12 cm/8 cm	12 cm/8 cm
Play time	74 min./20 min.	74 min./20 min.

Note on VIDEO CDs

This system conforms to VIDEO CDs without PBC functions (Ver. 1.1) and VIDEO CDs with PBC functions (Ver. 2.0) of VIDEO CD standards. You can enjoy two kinds of playback according to the disc type.

Disc type	You can
VIDEO CDs without PBC functions (Ver. 1.1 discs)	Enjoy video playback (moving pictures) as well as audio CDs.
VIDEO CDs with PBC functions (Ver. 2.0 discs)	Play interactive software using menu screens displayed on the TV screen (menu playback), in addition to the video playback function of VIDEO CDs without PBC functions. Moreover, you can play high or standard quality still picture.

PBC = Play Back Control

Table of Contents

Parts Identification

Main unit	4
Remote control	5

Getting Started

Hooking up the system	6
Inserting two size AA (R6) batteries into the remote	8
Setting the time	8
Saving the power in standby mode	8

VIDEO CD/CD

Loading a disc	9
Playing a VIDEO CD — Normal Play/Shuffle Play/ Repeat Play	9
Playing a VIDEO CD with the PBC functions (Ver.2.0) — PBC Play	11
Playing a CD — Normal Play/Shuffle Play/ Repeat Play	12
Playing VIDEO CD/CDs without interruption — Non-Stop Play	13
Programming the VIDEO CD/CD tracks — Program Play	13
DJ Effects	14
Using the VIDEO CD/CD display	14
Using the on-screen display	15
Locating a specific part of a disc — Scene Search	16
— Time Search	17
— Disc Digest	17
— Track Digest	18
Resuming playback from the point you stopped a VIDEO CD — Resume Play	18
Setting the sharpness — Active Picture	19

Tuner

Presetting radio stations	20
Listening to the radio — Preset Tuning	21

Tape

Loading a tape	22
Playing a tape	22
Recording to a tape — CD Synchro Recording/ High Speed Dubbing/Recording Manually/Program Edit	23
Timer-recording radio programs	25

Sound Adjustment

Adjusting the sound	26
Selecting the audio emphasis effect ...	26
Selecting the surround effect	26
Making a personal audio emphasis file — Personal File	27

Other features

Changing the spectrum analyzer display	28
Singing along: Karaoke	28
Enhancing video game sound — Game Sync	29
Falling asleep to music — Sleep Timer	29
Waking up to music — Daily Timer	30

Hooking up optional components

Connecting an MD deck/VCR/ camcorder/video game	31
Connecting a turntable	32

Additional Information

Precautions	33
Troubleshooting	34
Specifications	36
Glossary	39

The items are arranged in alphabetical order.

Refer to the pages indicated in parentheses () for details.

Main unit

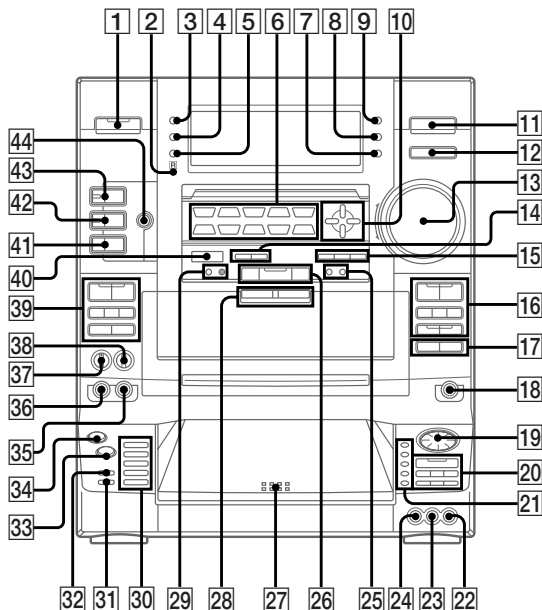

ACTIVE **21** (19)
 A EJECT ▲/▲ B EJECT **28** (22)
 AUDIO L jack **23** (31)
 AUDIO R jack **22** (31)
 CD FLASH **33** (14)
 CD LOOP **34** (7,14)
 CD SYNC **17** (23,24)
 DIRECT EQUALIZER **6** (26)
 SALSA REGGAE
 SAMBA TANGO
 MOVIE POP
 ROCK JAZZ
 DANCE GAME
 DIRECTION **39** (22,23,24,29)
 DISC SKIP **20** (9~13,18,24)
 DISC 1~5 **30** (10,12)
 DISPLAY **4** (8,14)
 DOLBY NR **39** (22,23)
 ECHO LEVEL **38** (28)
 EDIT **32** (24)
 ENTER **29** (20)
 ENTER/NEXT **15** (8,25,27,30,36)
 FLAT **15** (26)
 FUNCTION **11**
 (7,12,13,23,24,29,31,32)

GAME **12** (29,31)
 GROOVE **43** (26)
 H SPEED DUB **17** (23)
 IR receptor **2**
 Jog dial (AMSI◀◀/▶▶) **19**
 (10~14,18,24)
 KARAOKE PON/MPX **40** (28)
 KEY CONTROL **b/#** **14** (28)
 MIC 1 jack **36** (28)
 MIC 2 jack **35** (28)
 MIC LEVEL **37** (28)
 NEXT **21** (10,11,17,18)
 NON STOP **31** (13)
 P.FILE **15** (26,27)
 PHONES jack **18**
 PLAY MODE **20** (9,12,13,18,24)
 POWER SAVE/DEMO
 (STANDBY) **3** (8)
 PREV **21** (10,11,17,18)
 PUSH OPEN **27** (9,10,12)
 REPEAT **20** (10,12)
 RETURN **21** (11)
 SELECT **21** (11)
 SLEEP **8** (29)
 SPECTRUM ANALYZER **5** (28)
 STEREO/MONO **25** (21)

SUPER WOOFER **42** (26,32)
 SUPER WOOFER MODE **41** (26)
 SURROUND **44** (23,26)
 TIMER SELECT **9** (25,30)
 TUNER/BAND **26** (20,21,23)
 TUNER MEMORY **29** (20)
 TUNING MODE **25** (20,21)
 VIDEO jack **24** (31)
 VOLUME control **13** (21)

BUTTON DESCRIPTIONS

I/⏻ **1**
 ⌚/CLOCK SET **7**
 ▲▼◀▶ **10**
 ● REC **16**
 || **16**
 ◀▶▶▶, AMSI◀◀/▶▶
 (TAPE A/B) **16** **39**
 ◀/▶ **16** **39**
 ■ **16** **20** **39**
 ▶▶▶▶ (CD/VCD) **20**
 ◀|| **20**
 +/- **26**

Remote control

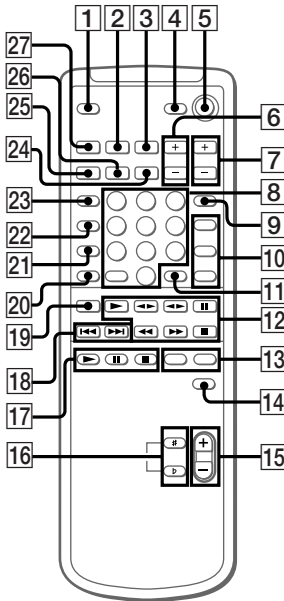

- ACTIVE **21** (19)
- CHECK **26** (13)
- CLEAR **24** (13,17)
- DECK A **◀▶** **12** (22)
- DECK B **◀▶** **12** (22)
- DISPLAY **2** (8,14)
- D.SKIP **25** (9~13,17,18,24)
- EDIT **22** (24)
- FILE SELECT ON/OFF **10** (26)
- FILE SELECT **▲▼** **10** (14)
- FLASH **13** (14)
- FUNCTION **20**
(7,12,13,23,24,29,31,32)
- KEY CONTROL **b/#** **16** (28)
- LOOP **13** (14)
- MD **▶** **17**
- MD **||** **17**
- MD **■** **17**
- NEXT, +, **▶▶▶** **18**
(10,11,12,17,18,21,22)
- Numeric buttons **8** (10,11,16~18)
- ON SCREEN **3** (15,16)
- PREV, -, **◀◀** **18**
(10,11,12,17,18,21,22)
- REPEAT **23** (10,12)

- SELECT CD **▶** **12**
(9,10,12,16~18)
- SLEEP **27** (29)
- SPECIAL MENU **9** (16~18)
- SURROUND **14** (23,26)
- TUNER/BAND **19** (20,21,23)
- TV CH +/- **7** (8)
- TV/VIDEO **1** (8)
- TV VOL +/- **6** (8)
- TV **I/O** **4** (8)
- VOL +/- **15** (21)

BUTTON DESCRIPTIONS

- I/O** **5**
- ↻** RETURN **11**
- **12**
- ◀/▶** **12**
- ||** **12**

Hooking up the system

Do the following procedure **1** to **6** to hook up your system using the supplied cords and accessories.

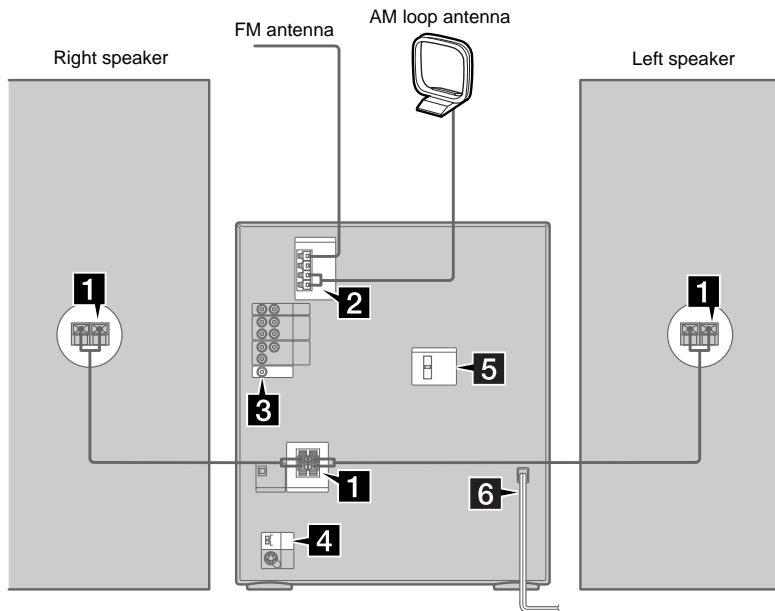

1 Connect the speakers.

Connect the speaker cords to the FRONT SPEAKER jacks as below.

Insert only the stripped portion.

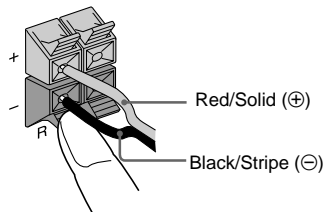

2 Connect the FM/AM antennas.

Set up the AM loop antenna, then connect it.

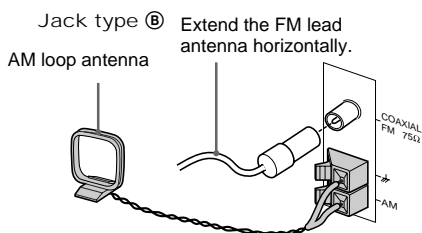
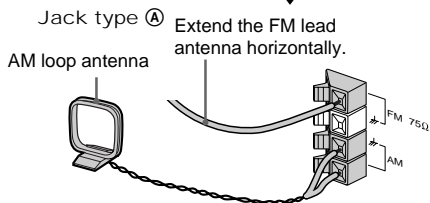
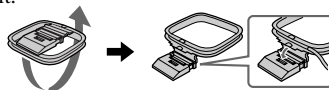

- 3** Connect the video input jack of your TV to the VIDEO OUT jack of this system using the supplied video connecting cable.

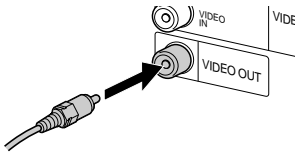

When using a TV

Turn on the TV and select the video input to view pictures from this system.

Tip

When your TV has an S VIDEO jack, for the best picture quality, you can use an optional S VIDEO cable to connect it to the S VIDEO OUT jack on the rear panel of this system. Note that the input signal from the VIDEO and GAME INPUT jacks do not output via the S VIDEO OUT jack.

- 4** Set SYSTEM SELECT (color system) to the appropriate position (PAL or NTSC), according to your TV.

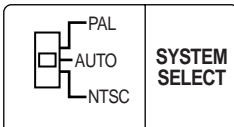

- 5** For models with a voltage selector, set VOLTAGE SELECTOR to the position of your local power line voltage.

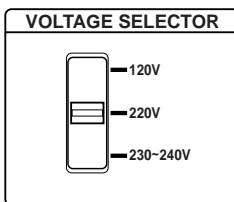

- 6** Connect the power cord to a wall outlet.

The demonstration appears in the display.

When you press I/⏻, the system turns on and the demonstration automatically ends.

If the supplied adaptor on the plug does not fit your wall outlet, detach it from the plug (only for models equipped with the adaptor).

Notes

- Keep the speaker cords away from the antennas to prevent noise.
- When you play back a VIDEO CD recorded in a different color system from the one you set on the unit, the picture image may be distorted.
- Be sure to turn off the system before changing the SYSTEM SELECT setting.

When carrying this system

Do the following to protect the CD mechanism. Make sure that all discs are removed from the unit.

- 1 Press FUNCTION repeatedly until "CD" appears.
- 2 Hold down CD LOOP and press I/⏻ to turn off the system.

"LOCK" appears in the display.

It is now safe for transportation.

Before connecting the Front speaker

Stick the supplied front speaker pads to the bottom of the front speakers to stabilize the speakers and prevent them from slipping.

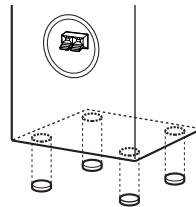

Inserting two size AA (R6) batteries into the remote

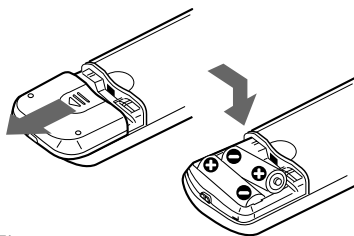

Tip

When the remote no longer operates the system, replace both batteries with new ones.

Note

If you do not use the remote for a long period of time, remove the batteries to avoid possible damage from battery leakage.

Using the remote

You can control Sony TVs using the buttons below.

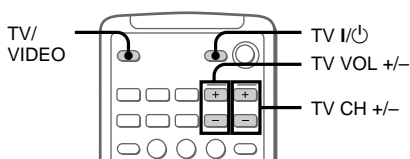

By pressing	You can
TV I/⏻	Turn on or off the TV
TV/VIDEO	Select the input source for the TV
TV VOL +/-	Adjust the volume of the TV
TV CH +/-	Change the channel of the TV

Note

Depending on the TV, you may not be able to control your TV or to use some of the buttons above.

Setting the time

- 1 Turn on the system.
- 2 Press **⏻/CLOCK SET**.
When you set the time for the first time, skip to step 5.
- 3 Press **▲/▼** repeatedly to select **“SET CLOCK.”**
- 4 Press **ENTER/NEXT**.
- 5 Press **▲/▼** repeatedly to set the hour.
The minute indication flashes.
- 6 Press **ENTER/NEXT**.
The minute indication flashes.
- 7 Press **▲/▼** repeatedly to set the minute.
- 8 Press **ENTER/NEXT**.
The clock starts working.

Tip

If you've made a mistake or want to change the time, start over from step 2.

Note

The clock settings are canceled when you disconnect the power cord or if a power failure occurs.

Saving the power in standby mode

Press POWER SAVE/DEMO (STANDBY) when the power is off. Every time you press the button, the system switches as follows:

Power Saving Mode ↔ Demonstration

The system is turned on/off by pressing **I/⏻**.

Tips

- The **I/⏻** indicator lights up even in the Power Saving Mode.
- The timer works in the Power Saving Mode.
- Everytime you press **DISPLAY** when the power is off, the display changes as follows:
Demonstration ↔ Clock

Note

You cannot set the time in the Power Saving Mode.

To cancel the Power Saving Mode Press **POWER SAVE/DEMO (STANDBY)** to show the demonstration.

Loading a disc

1 Press PUSH OPEN.

The front cover opens.

2 Place a VIDEO CD/CD with the label side up on the disc tray.

When you play a CD single, place it on the inner circle of the tray.

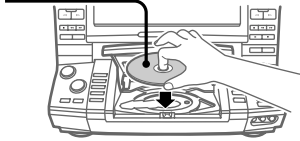

To insert additional discs, press DISC SKIP (or D.SKIP on the remote) to rotate the disc tray.

3 Close the front cover.

Playing a VIDEO CD

—Normal Play/Shuffle Play/Repeat Play

You can play both VIDEO CDs without PBC functions (Ver.1.1) and VIDEO CDs with PBC functions (Ver.2.0).

This unit lets you play the VIDEO CD in different play modes.

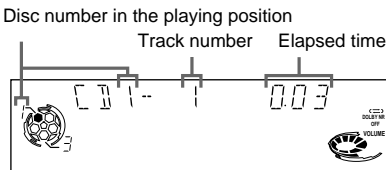

1 Turn on your TV and select the video input.

Refer to the instructions included with your TV for details.

2 Press PLAY MODE repeatedly until the mode you want appears.

Select	To play
ALL DISCS	All VIDEO CDs in the disc tray continuously.
1 DISC	The VIDEO CD you selected in the original order.
ALL DISCS SHUFFLE	The tracks on all VIDEO CDs in random order.
1 DISC SHUFFLE	The tracks on the VIDEO CD you selected in random order.
PROGRAM	The tracks on all VIDEO CDs in the order you want them to be played (see "Programming the VIDEO CD/CD tracks" on page 13).

3 Press (or SELECT CD on the remote).

continued

Playing the VIDEO CD (continued)

Other Operations

To	Do this
Stop playback	Press ■.
Pause	Press ▷ (or on the remote)* ¹ . Press again to resume play (or SELECT CD ► on the remote).
Select a track	Press NEXT to go forward, PREV to go back. Or, during play or pause, turn the jog dial clockwise (to go forward) or counterclockwise (to go backward) and release it when you reach the desired track. (Or press ►► (to go forward) or ◄◄ (to go backward) on the remote.)* ²
Find a point in a track or scene (Lock Search function)	Press ►► or ◄◄ during playback. ① Press once to start searching. ② Press again to increase the search speed. Each time you press the button, the speed changes as follows: 1(slow) → 2 (normal) → 3 (high) → 1(slow)... ③ Press ▷ at the desired point to stop searching.
Select a VIDEO CD in stop mode	Press one of the DISC 1~ 5 or DISC SKIP (or D.SKIP on the remote).
Switch to VIDEO CD function from another source	Press any of the buttons, DISC 1~ 5 or ▷ (or SELECT CD ► on the remote) (Automatic Source Selection).

Play repeatedly (Repeat Play)

Press REPEAT during playback until "REPEAT" or "REPEAT1" appears.
REPEAT: For all the tracks on the VIDEO CD.
REPEAT1*: For a single track only.
To cancel playing repeatedly, press REPEAT until "REPEAT" or "REPEAT1" disappears.

Remove the VIDEO CD

Press PUSH OPEN.

*¹ There may be some disturbance in the paused video image.

*² Only for VIDEO CDs without PBC functions (Ver. 1.1).

Tips

- You can start playing from the desired track (or scene for VCD) by pressing the numeric buttons on the remote in stop mode.
To enter track number 10 or over, first press >10, then press numeric buttons.
To enter 0, press 10/0.
e.g.) To enter track number 30, press >10, then 3 and 10/0.
- You can change the VIDEO CD in the loading position during playback of the VIDEO CD in the playing position.

Playing a VIDEO CD with the PBC functions (Ver. 2.0)

— PBC Play



You can use menus on your TV screen to enjoy the disc's interactive software. The menu format and structure will differ with each disc.

1 Start playing a VIDEO CD with PBC functions (Ver. 2.0).

A PBC menu appears on your TV and "PBC" appears in the display.

2 Turn the jog dial to select a number from the menu, then press SELECT.

3 Continue according to the instructions on the menus to enjoy interactive playback.

To	Do this
Stop play	Press ■.
See the rest of a menu	Press NEXT.
Go back to the top of a menu	Press PREV.
Go back to a previous menu	Press RETURN (or  RETURN on the remote).
Cancel playback with PBC functions (Ver.2.0)	In the stop mode, turn the jog dial (or press  /  on the remote) to select the desired track, then press SELECT (or press the numeric buttons on the remote). The PBC OFF indicator lights up and playback begins from the selected track. Still images such as menu screens will not be shown.
Select a menu number using the remote	Press numeric buttons (see Tips on page 10).

Tips

- When  appears on the TV screen, you have pressed an invalid button. Press a button indicated by the instructions on the menu screen.
- When you press NEXT while playing moving pictures, the next scene on the disc appears.
- "PBC" appears for the disc with PBC functions, and "PBC OFF" appears when its function is canceled.

Note

During playback, you cannot go to the next disc, even if you've selected "ALL DISCS."

Press DISC SKIP (or D. SKIP on the remote) to go to the next disc.

Playing a CD

— Normal Play/Shuffle Play/Repeat Play

This unit lets you play CDs in different play modes.

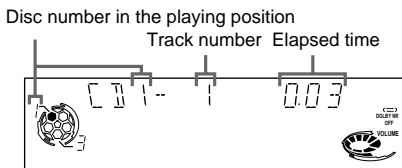

1 Press **FUNCTION** repeatedly until “CD” appears.

2 Press **PLAY MODE** repeatedly until the mode you want appears.

Select	To play
ALL DISCS	All CDs in the disc tray continuously.
1 DISC	The CD you selected in the original order.
ALL DISCS SHUFFLE	The tracks on all CDs in random order.
1 DISC SHUFFLE	The tracks on the CD you selected in random order.
PROGRAM	The tracks on all CDs in the order you want them to be played (see “Programming the VIDEO CD/CD tracks” on page 13).

3 Press **▷||** (or **SELECT CD ►** on the remote).

Other Operations

To	Do this
Stop playback	Press ■ .
Pause	Press ▷ (or on the remote). Press again to resume play.
Select a track	During play or pause, turn the jog dial clockwise (to go forward) or counterclockwise (to go backward) (or press ◀◀ (to go forward) or ▶▶ (to go backward) on the remote).
Find a point in a track (Lock Search Function)	Press ▶▶ or ◀◀ during playback. Press ▷ at the desired point to stop searching.
Select a CD	Press DISC 1~5 or DISC SKIP (or D.SKIP on the remote).
Switch to CD function from another source	Press DISC 1~5 or ▷ (or SELECT CD ► on the remote) (Automatic Source Selection).
Play repeatedly (Repeat Play)	Press REPEAT during playback until “REPEAT” or “REPEAT1” appears. REPEAT : For all the tracks on the CD. REPEAT1 : For a single track only. To cancel playing repeatedly, press REPEAT until “REPEAT” or “REPEAT1” disappears.
Remove the CD	Press PUSH OPEN .

Tip

You can change the CD in the loading position during playback of the CD in the playing position.

Playing VIDEO CD/CDs without interruption

— Non-Stop Play

You can play VIDEO CD/CDs without pausing between tracks.

- 1 Press **FUNCTION** repeatedly until “CD” appears.
- 2 Press **NON STOP** so that the indicator on this button lights up.
- 3 Press **▷||**.

To cancel Non-Stop Play

Press **NON STOP** so that the indicator on this button goes off.

Programming the VIDEO CD/CD tracks

— Program Play

You can make a program of up to 32 tracks from all the VIDEO CD/CDs in the order you want them to be played.

- 1 Press **FUNCTION** repeatedly until “CD” appears.
- 2 Press **PLAY MODE** repeatedly until “PROGRAM” appears.
- 3 Press **DISC SKIP** (or **D.SKIP** on the remote) to select a VIDEO CD/CD.
- 4 Turn the jog dial until the track you want appears.
- 5 Press **PLAY MODE** once.
The track is programmed. First “STEP” and the programmed playing order appear, then the total playing time appears.
- 6 To program additional tracks, repeat steps 3 to 5.
Skip step 3 to select tracks from the same disc.
- 7 Press **▷||**.

To	Press
Cancel Program Play	PLAY MODE repeatedly until “PROGRAM,” “ALL DISCS SHUFFLE,” or “1 DISC SHUFFLE” disappears.
Check the program	CHECK on the remote repeatedly. After the last track, “CHECK END” appears.
Clear a track from the end	CLEAR on the remote in stop mode.
Clear a specific track in stop mode	CHECK on the remote repeatedly until the number of the track to be erased lights up, then press CLEAR.
Add a track to the program in stop mode	<ol style="list-style-type: none"> 1 Press DISC SKIP (or D.SKIP on the remote) to select a VIDEO CD/CD. 2 Turn the jog dial to select a track. 3 Press PLAY MODE.
Clear the entire program	■ once in stop mode or twice while playing.

Tips

- The program you made remains in the CD player after it has been played back. Press **▷||** to play the same program again.
- If “--.--” appears instead of the total playing time during programming, this means:
 - you have programmed a track number which exceeds 20.
 - the total playing time has exceeded 100 minutes.

DJ Effects

Looping and flashing part of a CD

With the loop function, you can repeat part of a CD during playback. With the flash function, you can “flash” part of a CD sound during playback. Both functions let you create original recordings.

To	Do this
Start the function at the point you want	Press and hold CD LOOP or CD FLASH during playback.
Resume normal play	Release CD LOOP or CD FLASH.
Adjust the function length (LOOP lengths or FLASH lengths)	Turn the jog dial while holding CD LOOP or CD FLASH (or press FILE SELECT ▲/▼ while holding LOOP or FLASH on the remote).
Use FLASH and LOOP together	Press and hold both CD LOOP and CD FLASH at the same time.

Notes

- Adjust the loop and flash lengths independently before using the functions if necessary.
- To record the loop or flash effect, use the tape deck on this unit.

Using the VIDEO CD/CD display

You can check the remaining time of the current track or that of the VIDEO CD/CD.

Press DISPLAY.

Each time you press this button, the information changes as follows:

During normal playback

Playing time on the current track →
Remaining time on the current track →
Remaining time on current VIDEO CD/CD (1 DISC mode) or “--.--” display (ALL DISCS mode) → Clock display (for a few seconds) → Effect status

VIDEO CD with PBC functions (Ver. 2.0):

Playing time on the current track* → Clock display (for eight seconds) → Effect (P.FILE) name or “EFFECT ON (OFF)”

* May not appear with still images, etc.

In the stop mode

When the CD player is in program mode and there is a program:

The last track number of the program and the total playing time → The last track number of the current VIDEO CD/CD and the total playing time → Clock display (for a few seconds) → Effect status

In other conditions:

The current disc number → Total number of tracks and total playing time → Clock display (for a few seconds) → Effect status

Using the on-screen display

You can check the current operating status and disc information of VIDEO CDs or audio CDs during playback or in stop mode.

Press ON SCREEN on the remote.

Each time you press this button, the on-screen display changes as follows:

ON SCREEN 1 → ON SCREEN 2 →

ON SCREEN OFF → ON SCREEN 1.....

ON SCREEN 1,2 display

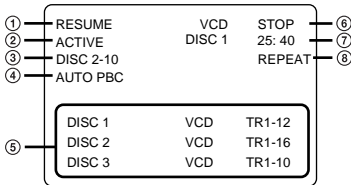

① When	The display shows:
In stop mode	“RESUME” or no display

② “ACTIVE” or no display

③ When	The display shows:
During playback	Current disc and track number*

* For VIDEO CD, only ON SCREEN 2 displays current disc and track number. “SCENE” and number is displayed during playback of a VIDEO CD with PBC functions.

④ Play mode or “AUTO PBC”*

* “AUTO PBC” appears for a VIDEO CD with PBC functions.

⑤ When	The display shows:
During playback or in stop mode (ON SCREEN1 only)	Music calendar*
In Program Play mode	Programmed disc and track number
In stop mode (ON SCREEN2 only)	Disc number and total track numbers of each disc**
Other condition	No display

* The track numbers in the numerical calendar disappear after they are played.

** Music calendar appears after SHUFFLE mode is selected.

⑥ When	The display shows:
In stop mode	“STOP”

⑦ When	The display shows:
During playback	Elapsed time of current disc or total playing time of the current disc*
In stop mode	Total playing time of the current disc

* In Program Play mode, total playing time of the program appears.

⑧ “REPEAT,” “REPEAT1” or no display

ON SCREEN OFF

No display (except for special menus)

Tip

Depending on conditions, some items are displayed and others are not.

Notes

- Normally, leave the display mode set to either ON SCREEN 1 or 2. When you select ON SCREEN OFF, you cannot check the operating status while operating the CD player. In this case, check the information on the front panel display.
- When you record video signals played back from this system onto a video tape (,etc.), be sure to select ON SCREEN OFF. Otherwise, the display information will also be recorded on the video tape.

Locating a specific part of a disc

— *Scene Search/Time Search/Disc Digest/Track Digest*

The TV screen must be ON to use these functions.

These functions cannot be used during playback of VIDEO CDs with PBC functions (Ver.2.0).

Use the remote for the operation.

To stop playback

Press ■.

To enter a number 10 or over with numeric buttons on the remote

Press the numeric buttons (see Tips on page 10).

To use Special Menu with VIDEO CDs with PBC functions (Ver.2.0)

Cancel the PBC functions (see “Cancel playback with PBC functions” on page 11).

Locating by Scene Number

— *Scene Search*

On VIDEO CDs with PBC functions (Ver. 2.0), the menu screens, moving pictures, and still pictures are divided into “scenes” and each scene has an assigned scene number. This function lets you start playback from a specific scene.

1 Start playing a VIDEO CD with PBC functions (Ver. 2.0).

2 Press SPECIAL MENU.

3 Press 1 to select “1) SCENE SEARCH.”

“SCENE -” and the total number of scenes appear on the TV screen.

4 Press the numeric buttons (1 - 10/0) to select the desired scene.

See Tips on page 10.

5 Press SELECT CD ►.

Playback starts from the selected scene.

To stop playback

Press ■.

To check the scene number during playback

Press ON SCREEN repeatedly to select the ON SCREEN 2 display mode. The scene number appears on the TV screen (see “Using the on-screen display” on page 15 for details).

Notes

- On some CDs, you may not be able to start playing from the scene you select because starting playback from certain scenes is prohibited. In this case, play either starts from scene 1 (during stop mode) or continues from the current scene (during playback).
- Some CDs may not display the scene you select on the TV screen.

Locating by elapsed time

— *Time Search*

- 1** Press **SPECIAL MENU** in stop mode.
- 2** Press **2** to select “**2) TIME SEARCH.**”
- 3** Press the numeric buttons to enter the time (in minutes) for the desired section.
The selected elapsed time appears on the TV screen.
To reenter the time, press **CLEAR**, and then press the numeric buttons again.
- 4** Press **SELECT CD** ►.
Playback starts from the selected time.

Locating the desired track

— *Disc Digest*

You can select the desired track by viewing the first frame of each track. Either 9 or 12 different tracks can be displayed on the TV screen at one time.

- 1** Press **SPECIAL MENU** in stop mode.
- 2** Press **3** to select “**3) DISC DIGEST.**”
The first frame of tracks 1 through 9 (in default setting) on the current disc appear.
The sound of the first three seconds of each track on an audio CD plays, but there is no sound when using a VIDEO CD.
- 3** Press the numeric buttons to select the desired track.

To switch to a 12 frame display
You can switch the digest display from 9 to 12 frames.

- 1 Press **SPECIAL MENU**.
- 2 Press **5**.
- 3 Proceed with steps 1 and 2 of “Locating the desired track.” The first frame of tracks 1 through 12 appear.

To switch back to the 9 frame display, repeat this operation.

To display the next 9 or 12 tracks
Press **NEXT**. The first frame of tracks 10 through 18 (or 13 through 24) appear.

When there are more tracks in the disc, “►►” appears in the upper right corner of the TV screen.

To display previous tracks, press **PREV**.

To switch to the digest of another disc during disc digest
Press **D. SKIP** during disc digest.

continued

Locating a specific part of a disc (continued)

Locating a section within a track

— Track Digest

You can have the CD player divide a VIDEO CD track into either 9 or 12 different sections and display the first scene of each section on the TV screen.

1 Start playing the desired VIDEO CD track.

2 Press SPECIAL MENU.

3 Press 4 to select “4) TRACK DIGEST.”

The current track is divided into 9 sections (in default setting) and the first frame of each section appears.

The sound of the first three seconds of each track on an audio CD plays, but there is no sound when using a VIDEO CD.

4 Press the numeric buttons to select the desired section.

Playback starts from a point near the selected frame.

To switch to the digest of another track during track digest

Press PREV or NEXT during track digest; however, this does not work during Shuffle Play or Program Play.

Note

The play mode automatically switches to normal mode if you start disc digest during Shuffle or Program Play.

Resuming playback from the point you stopped a VIDEO CD

— Resume Play

The system memorizes the point where you stopped the VIDEO CD so you can resume from that point. Resume play is not canceled when you turn off the system.

Note that resume play is not available when playing an audio CD.

1 While playing a VIDEO CD, press ■ to stop playback.

“RESUME” appears on your TV screen. If “RESUME” does not appear, Resume Play is not available.

2 Press ▷|| (or SELECT CD ► on the remote).

The player starts playback from the point you stopped the VIDEO CD in step 1.

To view from the beginning of the VIDEO CD

When “RESUME” appears in the display, press ■, then press ▷|| (or SELECT CD ► on the remote).

Notes

- Resume Play is not available in the Digest, Shuffle, or Program Play modes.
- Depending on where you stopped the VIDEO CD, the player may resume playback from a different point.
- Resume play is cleared when:
 - you press numeric buttons, PLAY MODE, ■, DISC SKIP (or D.SKIP on the remote), or SPECIAL MENU or turn the jog dial.
 - you remove the VIDEO CD.
 - you unplug the system’s AC power cord.

Setting the sharpness

— *Active Picture*

This function emphasizes the outline of the picture to create a sharper image.

Press ACTIVE so “ACTIVE PICTURE” appears.

To cancel

Press ACTIVE again to display “ACTIVE OFF.”

Notes

- The active picture function is not available when playing audio CDs.
- “ACTIVE OFF” is selected automatically when you turn the system off.

Presetting radio stations

You can preset 20 stations for FM and 10 stations for AM.

1 Press TUNER/BAND repeatedly until the band you want appears.

Each time you press this button, the band changes as follows:

FM ↔ AM

2 Press TUNING MODE repeatedly until “AUTO” appears.

3 Press +/- until the frequency indication starts to change.

Scanning stops when the system tunes in a station. “TUNED” and “STEREO” (for a stereo program) appear.



4 Press TUNER MEMORY.

The next available preset number flashes in the display. The stations are stored from preset number 1.



5 Press ENTER.

“COMPLETE” appears and the station is stored.

6 Repeat steps 1 to 5 to store other stations.

To tune in a station with a weak signal

Press TUNING MODE repeatedly until “MANUAL” appears in step 2, then press +/- to tune in the station.

To set another station to the existing preset number

Start over from step 1. After step 4, press +/- to select the preset number you want to store for another station.

You can add a new preset number after the last preset number.

To erase the preset station

1 Hold down TUNER MEMORY until a preset number appears.

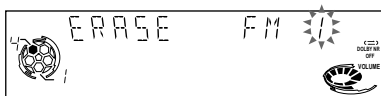

2 Press +/- to select the preset number you want to erase.

Select “ALL ERASE” when you want to erase all the preset stations.

3 Press ENTER.

“COMPLETE” appears.

When you erase a preset number, the preset number decreases by one and all preset numbers following the erased one are renumbered.

To change the AM tuning interval (Except for the Middle Eastern and Philippine models)

The AM tuning interval is factory set to 9 kHz (10 kHz in some areas). To change the AM tuning interval, tune in any AM station first, then turn off the power. While holding down the ENTER button, turn the power back on. When you change the interval, AM preset stations will be erased. To reset the interval, repeat the same procedure.

Tip

The preset stations are retained for half a day even if you unplug the power cord or if a power failure occurs.

Listening to the radio

— Preset Tuning

Preset radio stations in the tuner's memory first (see “Presetting radio stations” on page 20).

- 1 Press **TUNER/BAND** repeatedly until the band you want appears.
- 2 Press **TUNING MODE** repeatedly until “PRESET” appears.
Each time you press this button, the tuning mode changes cyclically as follows:
MANUAL → AUTO → PRESET
- 3 Press **+/-** (or **◀◀/▶▶** on the remote) to tune in the preset station you want.

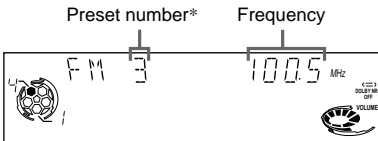

* When only one station is preset, “ONE PRESET” appears.



To	Do this
Turn off the radio	Press I/⏻.
Adjust the volume	Turn VOLUME (or press VOL +/- on the remote).

To listen to non-preset radio stations
Press **TUNING MODE** repeatedly in step 2 until “MANUAL” appears, then press **+/-** to tune in the desired station.

Tips

- When an FM program is noisy, press **STEREO/MONO** so that “MONO” appears. There will be no stereo effect, but the reception will improve.
- To improve broadcast reception, reorient the antennas.

Loading a tape





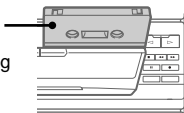



- 1 Press **A EJECT**  or **B EJECT** .
- 2 Insert a tape in deck A or B with the side you want to play facing forward.

Insert with the side you want to play/record facing forward.











Playing a tape

You can play any type of tape: TYPE I (normal), TYPE II (CrO₂), or TYPE IV (metal). The deck automatically detects the tape type.

- 1 Load a recorded tape.
- 2 Press **DIRECTION** repeatedly to select  to play one side. Select  to play both sides. Select **RELAY (Relay Play)*** to play both decks in succession.
- 3 Press  (or **DECK A** , **DECK B**  on the remote).
Press  (or **DECK A** , **DECK B**  on the remote) to play the reverse side. The tape starts playing.



* Relay Play always follows this cyclical sequence:
Deck A (front side) → Deck A (reverse side) →
Deck B (front side) → Deck B (reverse side)

To	Do this
Stop play	Press  .
Pause (deck B only)	Press  Press again to resume play.
Fast-forward	Press  or  in stop mode.
Rewind	Press  or  in stop mode.
Remove the cassette	Press A EJECT  (or B EJECT  .

Tips

- The deck stops automatically after repeating the sequence five times.
- You can fast-forward or rewind the tape, regardless of the selected source.
- When you want to reduce the hiss noise in low-level high-frequency signals, press **DOLBY NR** so that “DOLBY NR B” appears.

Searching for the beginning of a track (AMS)

During playback, press  or  repeatedly for the number of songs you want to skip forward (or backward).

The search direction, + (forward) or - (back), and number of songs being skipped (1~9) appear.

Example: searching forward 2 songs

T A P E R : : : + 2

Note

The AMS function may not operate correctly under the following circumstances:

- When the unrecorded space between songs is less than 4 seconds long.
- When the unit is placed near a television.

Recording to a tape

— CD Synchro Recording/High Speed Dubbing/Recording Manually/ Program Edit

You can record from a VIDEO CD/CD, tape, or radio. You can use TYPE I (normal) or TYPE II (CrO2) tapes. The recording level is adjusted automatically.

Steps	Recording from a VIDEO CD/CD (CD Synchro Recording)	Recording from a tape (High-Speed Dubbing)	Recording Manually
1	Insert a recordable tape into deck B.		
2	Press FUNCTION repeatedly until “CD” appears.	Press FUNCTION repeatedly until “TAPE” appears.	Press FUNCTION or TUNER/BAND repeatedly until the source or band you want to record appears.
3	Insert the VIDEO CD/CD you want to record.	Insert the tape you want to record into deck A.	Insert the VIDEO CD/CD/tape, or tune to the station you want to record.
4	Press CD SYNC.	Press H SPEED DUB.	Press ● REC.
	DECK B stands by for recording. To reduce the hiss noise in low-level high frequency signals, press DOLBY NR so that “DOLBY NR B” appears in the display (except when recording from a tape).		
5	Press DIRECTION repeatedly to select \rightleftarrows to record on one side. Select \leftrightarrow (or RELAY) to record on both sides.		
6	Press II . Recording starts.		
7			Start playing the source to be recorded.

To stop recording

Press **■**.

Tips

- When you want to record on the reverse side, press \triangleleft after pressing **● REC** so that the indicator on the \triangleleft button (for the reverse side) lights up green.
- When you record on both sides, be sure to start from the front side. If you start from the reverse side, recording stops at the end of the reverse side.
- For recording from the tape:
If you set the direction to \leftrightarrow when the tapes you use have different lengths, the tapes in each deck reverse independently. If you select **RELAY**, the tapes in both decks reverse together.
- To record with the surround effect, press **SURROUND** so that “SUR ((((((■))))))” appears. The equalizer setting effects will not be recorded.
- For recording from the radio:
If noise is heard while recording from the radio, move the respective antenna to reduce the noise.

continued

Recording to a tape (continued)

Recording a VIDEO CD/CD by specifying track order

— Program Edit

When programming, make sure the playing times for each side do not exceed the length of one side of the tape.

- 1 Load VIDEO CD/CDs and a recordable tape into deck B, then press FUNCTION repeatedly until "CD" appears.**
- 2 Press PLAY MODE repeatedly until "PROGRAM" appears.**
- 3 Select a VIDEO CD/CD and track by pressing DISC SKIP (or D.SKIP on the remote) and turning the jog dial, then press PLAY MODE once.**
Repeat this procedure to program the remaining tracks for side A.
- 4 Press II on the remote to insert a pause at the end of side A.**
"P" appears and the total playing time resets to "0.00" in the display.
- 5 Repeat step 3 to program the remaining tracks to be recorded on side B.**
- 6 Press CD SYNC.**
Deck B stands by for recording.
- 7 Press DIRECTION repeatedly to select \rightleftarrows to record on one side.**
Select \leftrightarrow (or RELAY) to record on both sides.
- 8 Press II.**
Recording starts.
- 9 Press ■ on the deck B and the CD player to stop recording.**

Tip

To check the required tape length for recording a VIDEO CD/CD, press EDIT so that "EDIT" flashes after you have loaded a VIDEO CD/CD and switched the function to CD. The required tape length for the currently selected VIDEO CD/CD appears, followed by the total playing time for side A and side B respectively (Tape Select Edit).

Notes

- You cannot use Tape Select Edit for discs containing over 20 tracks.
- You cannot use this function when Program Play mode has been set. After clearing the entire program, follow the above procedure.

Timer-recording radio programs

To timer-record, you must preset the radio station (see “Presetting radio stations” on page 20) and set the clock (see “Setting the time” on page 8) beforehand.

- 1 Tune in the preset radio station (see “Listening to the radio” on page 21).**
- 2 Press \odot /CLOCK SET.**
- 3 Press $\blacktriangle/\blacktriangledown$ repeatedly to select “REC,” then press ENTER/NEXT.**
“ON” appears and the hour indication flashes in the display.
- 4 Set the time to start recording.**
Press $\blacktriangle/\blacktriangledown$ to set the hour, then press ENTER/NEXT.
The minute indication starts flashing.
Press $\blacktriangle/\blacktriangledown$ to set the minute, then press ENTER/NEXT.
The hour indication flashes again.
- 5 Set the time to stop recording following the above procedure.**
The start time appears, followed by the stop time, the preset radio station to be recorded (e.g., “TUNER FM 5”), then the original display appears.
- 6 Insert a recordable tape into deck B.**
- 7 Turn off the power.**
When the recording starts, the volume level is set to minimum.

To	Do this
Check the setting	Press TIMER SELECT, then press $\blacktriangle/\blacktriangledown$ to select “SEL REC,” then press ENTER/NEXT. To change the setting, start over from step 1.
Cancel timer operation	Press TIMER SELECT, then press $\blacktriangle/\blacktriangledown$ to select “TIMER OFF,” then press ENTER/NEXT.

Notes

- The system turns on 15 seconds before the preset time.
- If the system is on at the preset time, the Timer recording will not be made.
- When you use the Sleep Timer, Daily Timer and Timer recording will not turn on the system until the Sleep Timer turns it off.
- Recording starts from the front side.

Adjusting the sound

To reinforce lower bass sound (SUPER WOOFER)

Press SUPER WOOFER.

Each time you press this button, the super woofer level display changes cyclically as follows:

SUPER WOOFER FLAT → LOW → HIGH

To select the super woofer mode

Press SUPER WOOFER MODE while the super woofer is on.

Each time you press this button, the super woofer mode display changes as follows:

MODE MOVIE ↔ MODE MUSIC

For a powerful sound (GROOVE)

Press GROOVE.

The volume switches to power mode, the equalizer curve changes, and the indicator on the GROOVE button lights up.

Press GROOVE again to return to the previous volume.

Note

Canceling the Groove mode cancels the equalizer curve and super woofer level. Adjust the equalizer settings to obtain the desired effect.

Selecting the audio emphasis effect

Selecting the preset effect from the music menu

Press the desired DIRECT EQUALIZER button.

The preset effect name appears.

See the chart “Music menu options.”

To	Press
Select USER FILE	P.FILE
Cancel the effect	FLAT (or FILE SELECT ON/OFF on the remote)

Music menu options

“SUR(|||||■|||||)” appears if you select an effect with surround effects.

Effect	For
SALSA	standard music sources
REGGAE	
SAMBA	
TANGO	
MOVIE	
POP	
ROCK	
JAZZ	
DANCE	
GAME	

Selecting the surround effect

Press SURROUND.

Every time you press the button, the display changes as follows:

SURROUND ON (SUR(|||||■|||||))
 ↓
 SURROUND OFF

Making a personal audio emphasis file

— *Personal File*

You can create personal files of audio patterns (surround effect and graphic equalizer) and store them in the system's memory. Later, you can call up an audio pattern when playing a favorite tape, VIDEO CD/CD, or radio program. Before operating, first select the basic audio emphasis you want for your sound.

- 1 Press ◀/▶ to select the frequencies, then press ▲/▼ to adjust the level.

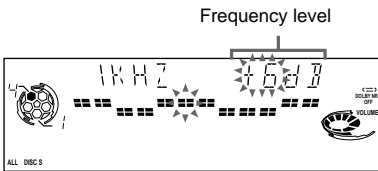

- 2 Press ENTER/NEXT.

This setting is automatically stored as P.FILE.

Any settings previously stored at this memory location are erased and replaced by the new settings.

To call up the personal file

Press P.FILE.

Tip

If you choose another audio emphasis, the adjusted sound effect is lost. To retain the adjusted sound effect, press P.FILE.

Changing the spectrum analyzer display

Press SPECTRUM ANALYZER.

Each time you press the button, the display changes cyclically as follows:

IMAGE ILLUMINATION → IMAGE →
NORMAL ILLUMINATION → NORMAL

Singing along: Karaoke

You can sing along with any stereo CD or tape by turning down the singer's voice. You need to connect an optional microphone.

- 1 Turn MIC LEVEL to MIN to turn down the microphone control level.
- 2 Connect an optional microphone to MIC1 or MIC2.
- 3 Press KARAOKE PON/ MPX repeatedly to obtain the karaoke effect you desire.

Each time you press the button, the display changes as follows:

KARAOKE PON → MPX R → MPX L
→ Effect status

The  indicator appears when karaoke mode is activated.

To sing karaoke of multiplex CD, select "MPX R" or "MPX L."

- 4 Start playing the music and adjust the volume.
- 5 Adjust the microphone volume by turning MIC LEVEL.

To	Do this
Use VIDEO CDs	Turn on your TV and switch it to the appropriate video input.
Cancel karaoke mode	Turn MIC LEVEL to MIN and disconnect the microphone from MIC1 or MIC2, then press KARAOKE PON/ MPX repeatedly until "  " disappears.
Adjust the microphone echo	Turn ECHO LEVEL to adjust the echo effect. To cancel the echoing, turn ECHO LEVEL to MIN.
Adjust the key	Press KEY CONTROL #/b to suit your vocal range. You can adjust the key higher or lower in 13 half-tone steps (b 6 ~ # 6). This function can be used with the CD player only.

Tip

You can connect two microphones to MIC1 and MIC2 at the same time.

Notes

- With some songs, vocals may not be canceled when you select "KARAOKE PON."
- During KARAOKE PON, equalizer and surround settings cannot be changed.
- If you select a sound effect, the karaoke mode is canceled.
- The instrumental sound may be reduced as well as the singer's voice when the sound is recorded in monaural.
- The singer's voice may not be reduced when:
 - only a few instruments are playing.
 - a duet is being played.
 - the source has strong echoes or chorus.
 - the singer's voice deviates from the center.
 - the voice on the source is singing in high soprano or tenor.

Mixing and recording sound

- 1 Do the procedure for “Singing along” (steps 1 through 5). Then, load a recordable tape in deck B.
- 2 Press **FUNCTION** repeatedly to select the source you desire and set it to pause mode.
- 3 Press **● REC**.
- 4 Press **DIRECTION** repeatedly to select \Rightarrow to record on one side. Select \Leftrightarrow (or **RELAY**) to record on both sides.
- 5 Press **II**.
- 6 Press \triangleright **II** to start playing the VIDEO CD/CD (or \triangleright on deck A to start playing the tape).

Start singing along with the music.

To stop recording

Press **■**.

Tips

- If acoustic feedback (howling) occurs, move the microphone away from the speakers or change the direction of the microphone.
- If you want to record your voice through the microphone only, you can do so by selecting the CD function and not playing a VIDEO CD/CD.
- When high level sound signals are input, the unit automatically adjusts the recording level to prevent distortion of the recorded sound signal (Auto Level Control Function).

Enhancing video game sound

— Game Sync

You can enjoy the sound effects of video games.

- 1 Connect a video game player (see “Connecting an MD deck/VCR/camcorder/video game” on page 31).
- 2 Press **GAME** on the right side corner of the front panel (see \square , “Parts Identification” on page 4).

Falling asleep to music

— Sleep Timer

You can have the system turn off at a preset time, so you can fall asleep to music.

Press **SLEEP**.

Each time you press the button, the minute display (the turn-off time) changes as follows:

AUTO \rightarrow 90 \rightarrow 80 \rightarrow 70 \rightarrow ... \rightarrow 10 \rightarrow
OFF \rightarrow AUTO* ...

* The power turns off when the current CD or tape finishes playback (for up to 100 minutes).

To	Press
Check the remaining time	SLEEP once.
Change the time to turn off	SLEEP to select the time you want.
Cancel the Sleep Timer function	SLEEP repeatedly until “SLEEP OFF” appears.

Waking up to music

— Daily Timer

You can wake up to music at a preset time every day. Make sure you have set the clock (see “Setting the time” on page 8).

1 Prepare the music source you want to play.

- VIDEO CD/CD: Load a VIDEO CD/CD. To start from a specific track, make a program (see “Programming the VIDEO CD/CD tracks” on page 13).
- Tape: Load a tape with the side you want to play facing forward.
- Radio: Tune in the preset station you want (see “Presetting radio stations” on page 20).

2 Adjust the volume.

3 Press \odot /CLOCK SET.

“SET” appears and “DAILY” flashes in the display.

4 Press $\blacktriangle/\blacktriangledown$ repeatedly to select “DAILY,” then press ENTER/NEXT.

“ON” appears and the hour digits flash in the display.

5 Set the time to start playback.

Press $\blacktriangle/\blacktriangledown$ repeatedly to set the hour, then press ENTER/NEXT.

The minute indication starts flashing.

Press $\blacktriangle/\blacktriangledown$ repeatedly to set the minute, then press ENTER/NEXT.

The hour indication flashes again.

6 Set the time to stop playback following the above procedure.

7 Press $\blacktriangle/\blacktriangledown$ repeatedly until the music source you want appears.

The indication changes as follows:

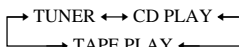

8 Press ENTER/NEXT.

The start time, stop time, and the music source appear, then the original display appears.

9 Turn off the power.

To	Do this
Check the setting	Press TIMER SELECT and then press $\blacktriangle/\blacktriangledown$ to select “DAILY;” then press ENTER/NEXT.
Change the setting	Start from step 1.
Cancel the timer operation	Press TIMER SELECT and then $\blacktriangle/\blacktriangledown$ to select “OFF;” then press ENTER/NEXT.

Note

When you use the Sleep Timer, Daily Timer and Timer recording will not turn on the system until the Sleep Timer turns it off.

Tip

The power turns on 15 seconds before the preset time.

Connecting an MD deck/ VCR/camcorder/video game

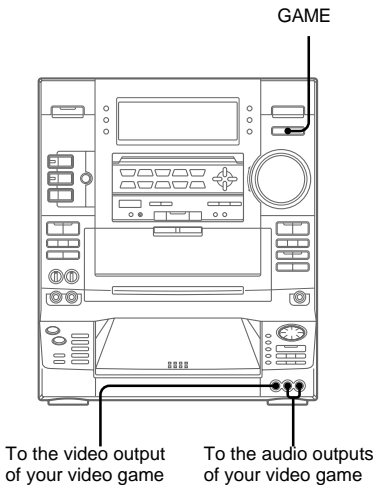
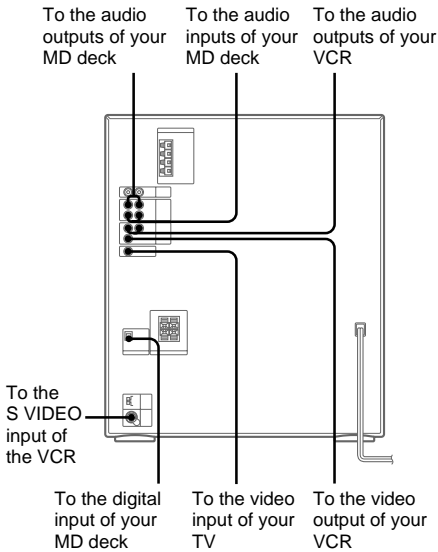

To	Do This
Make a digital recording from CD to MD	Connect the optical cable.
Listen to the connected MD deck	Press FUNCTION repeatedly until "MD" appears.
Listen to the connected VCR	Press FUNCTION repeatedly until "VIDEO" appears.
Listen to the sound from the connected camcorder or video game	Press FUNCTION repeatedly until "GAME" appears or press GAME at the right side corner on the front panel.

Notes

- If sound is distorted when you connect your VCR to the VCR input jack of the unit, connect your VCR to the MD input jack instead.
- Be sure to match the color of the plugs and the connectors.

Connecting a turntable

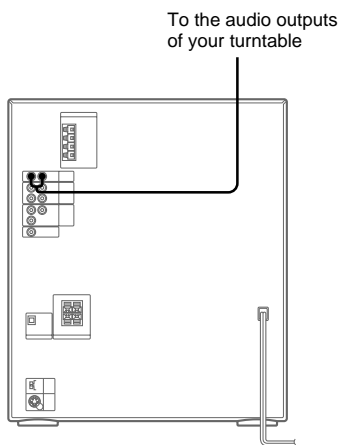

To	Do This
Listen to the connected turntable	Press FUNCTION repeatedly until "PHONO" appears.

Notes

- Using a turntable at high volume may cause distortion or howling. This is often caused by the bass sound from the speakers. The bass sound may produce the distortion or howling. To avoid this, do the following:
 - 1 Keep some distance between the speakers and the turntable.
 - 2 Stop using the surround effect.
 - 3 Place the speakers and the turntable on a firm and stable surface.
 - 4 Press SUPER WOOFER repeatedly until the indicator on this button goes off.

Precautions

On operating voltage

Before operating the unit, check that the operating voltage of your unit is identical with the voltage of your local power supply.

On safety

- The unit is not disconnected from the AC power source (mains) as long as it is connected to the wall outlet, even if the unit itself has been turned off.
- Unplug the unit from the wall outlet (mains) if it is not to be used for an extended period of time. To disconnect the cord (mains lead), pull it out by the plug. Never pull the cord itself.
- Should any solid object or liquid fall into the component, unplug the unit and have the component checked by qualified personnel before operating it any further.
- The AC power cord must be changed only at the qualified service shop.

On placement

- Do not place the unit in an inclined position.
- Do not place the unit in locations where it is:
 - extremely hot or cold
 - dusty or dirty
 - very humid
 - vibrating
 - subject to direct sunlight

On heat buildup

- Although the unit heats up during the operation, this is not the malfunction.
- Place the unit in a location with adequate ventilation to prevent heat build-up in the unit.

If you continuously use this unit at a large volume, the cabinet temperature of the top, side and bottom rises considerably. To avoid burning yourself, do not touch the cabinet.

To prevent a malfunction, do not cover the ventilation hole for cooling fan.

On operation

- If the unit is brought directly from a cold to a warm location, or is placed in a very damp room, moisture may condense on the lens inside the CD player. Should this occur, the unit will not operate properly. Remove the VIDEO CD/CD and leave the unit turned on for about an hour until the moisture evaporates.
- When you move the unit, take out any discs.

If you have any questions or problems concerning your unit, please consult your nearest Sony dealer.

Notes on VIDEO CD/CDS

- Before playing, clean the VIDEO CD/CD with a cleaning cloth. Wipe the VIDEO CD/CD from the center out.
- Do not use solvents.
- Do not expose the VIDEO CD/CD to direct sunlight or heat sources.
- Discs with non-standard shapes (e.g., heart, square, star) cannot be played on this unit. Do not use such discs.

Cleaning the cabinet

Use a soft cloth slightly moistened with mild detergent solution.

To save a tape permanently

To prevent a tape from being accidentally recorded over, break off the cassette tab from side A or B as illustrated.

If you later want to reuse the tape for recording, cover the broken tab with adhesive tape. However, be careful not to cover the detector slots which allow the tape player to automatically detect the type of tape.

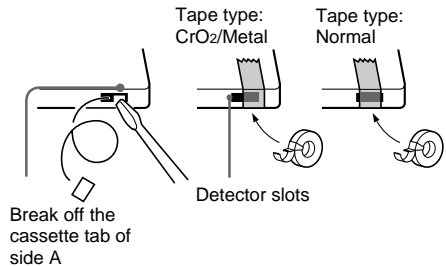
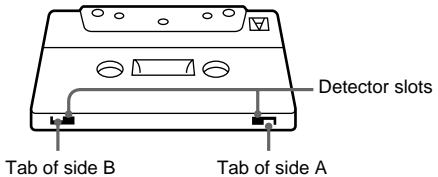

continued

Precautions (continued)

Before placing a cassette in the tape deck

Take up any slack in the tape. Otherwise the tape may get entangled in the parts of the tape deck and become damaged.

When using a tape longer than 90 minutes

The tape is very elastic. Do not change the tape operations such as play, stop, and fast-winding, etc. frequently. The tape may get entangled in the tape deck.

Cleaning the tape heads

Clean the tape heads after every 10 hours of use.

Make sure to clean the tape heads before you start an important recording or after playing an old tape. Use separately sold dry-type or wet-type cleaning cassette. For details, refer to the instructions of the cleaning cassette.

Demagnetizing the tape heads

Demagnetize the tape heads and the metal parts that have contact with the tape every 20 to 30 hours of use with a separately sold demagnetizing cassette. For details, refer to the instructions of the demagnetizing cassette.

In case color irregularity is observed on nearby a TV screen

With the magnetically shielded type of speaker system, the speakers can be installed near a TV set. However, color irregularity may still be observed on the TV screen depending on the type of your TV set.

If color irregularity observed...

Turn off the TV set once, then turn it on after 15 to 30 minutes.

If color irregularity is observed again...

Place the speakers farther away from the TV set.

Troubleshooting

If you run into any problem using this unit, use the following check list.

First, check that the power cord is connected firmly and the speakers are connected correctly and firmly.

Should any problem persist, consult your nearest Sony dealer.

General

The display starts flashing as soon as you plug in the power cord even though you haven't turned on the power.

- Refer to demonstration (see page 7, step 6).

The clock setting is canceled.

- The power cord is disconnected or a power failure occurs. Redo "Setting the time" (on page 8). If you have set the timer, redo "Waking up to music" (on page 30) and "Timer-recording radio programs" (on page 25).

The radio presetting/timer setting is canceled.

- The power cord is disconnected or a power failure occurs for longer than half a day. Redo "Presetting radio stations" (on page 20).

There is no sound.

- Turn VOLUME clockwise.
- The headphones are connected.
- Insert only the stripped portion of the speaker cord into the SPEAKER jack. Inserting the vinyl portion of the speaker cord will obstruct the speaker connections.
- The protective device on the amplifier has been activated because of a short circuit. ("PROTECT" and "PUSH POWER" flash alternately.) Turn off the unit, eliminate the short-circuit problem and turn on the power again.
- There is no audio output during timer recording.

There is no microphone sound.

- Turn VOLUME or MIC LEVEL to adjust the microphone volume.
- Make sure the microphone is connected to the MIC1 or MIC2 jack correctly.

There is severe hum or noise.

- A TV or VCR is placed too close to the stereo system. Move the stereo system away from the TV or VCR.
-

“0:00” (or “12:00 AM”) flashes in the display.

- A power interruption occurred. Set the clock and timer settings again.

The timer does not function.

- Set the clock correctly.

DAILY and REC do not appear when you press the /CLOCK SET button.

- Set the timer correctly.
- Set the clock.

The remote does not function.

- There is an obstacle between the remote and the system.
- The remote is not pointing in the direction of the system’s sensor.
- The batteries have run down. Replace the batteries.

There is acoustic feedback.



- Decrease the volume level.
- Move the microphone away from the speakers or change the direction of the microphone.

The color irregularity on a TV screen persists.

- Turn off the TV set once, then turn it on after 15 to 30 minutes. If the color irregularity still persists, place the speakers farther away from the TV set.

Speakers

“PROTECT” and “PUSH POWER” appear alternately.

- A strong signal was input. Press  to turn off the power, leave the system turned off for a while, then press  again to turn on the power.
- Check the speaker cables in case “PROTECT” and “PUSH POWER” appear alternately again after you turn the system on.

Sound comes from one channel or unbalanced left and right volume.

- Check the speaker connection and speaker placement.

VIDEO CD/CD Player

There is no picture.

- Check that the player is connected correctly and securely.
- Make sure you operate the TV correctly.
- Make sure you set the SYSTEM SELECT correctly, according to your TV (color) system.
- Press FUNCTION repeatedly until “CD” appears in the display.

An after image of the last picture remains on the screen, or the picture is unclear.

- Press ACTIVE repeatedly until “ACTIVE OFF” appears in the display.

The CD tray does not close.

- The VIDEO CD/CD is not placed properly.

The VIDEO CD/CD will not play.

- The VIDEO CD/CD is not lying flat in the disc tray.
- The VIDEO CD/CD is dirty (see “Notes on VIDEO CD/CDs” on page 33).
- The VIDEO CD/CD is inserted label side down.
- The VIDEO CD/CD is moist.

Play does not start from the first track.

- The player is in program or shuffle mode. Press PLAY MODE repeatedly until “PROGRAM,” “ALL DISCS SHUFFLE,” or “1 DISC SHUFFLE” disappears.

Tape Deck

The tape does not record.

- The tab has been removed from the cassette (see “To save a tape permanently” on page 33).
- The tape has reeled to the end.

The tape does not record or play, or there is a decrease in sound level.

- The heads are dirty (see “Cleaning the tape heads” on page 34).
- The record/playback heads are magnetized (see “Demagnetizing the tape heads” on page 34).

The tape does not erase completely.

- The record/playback heads are magnetized (see “Demagnetizing the tape heads” on page 34).

Troubleshooting (continued)

There is excessive wow or flutter, or the sound drops out.

- The capstans or pinch rollers are dirty (see “Cleaning the tape heads” on page 34).

Noise increases or the high frequencies are erased.

- The record/playback heads are magnetized (see “Demagnetizing the tape heads” on page 34).

Tuner

Severe hum or noise (“TUNED” or “STEREO” flashes in the display).

- Adjust the antenna.
- The signal strength is too weak. Connect the external antenna.

A stereo FM program cannot be received in stereo.

- Press STEREO/MONO so that “STEREO” disappears.

If other troubles not described above occur, reset the system as follows:

- 1** Press \ominus /CLOCK SET, ENTER/NEXT and I/\uparrow at the same time.
- 2** Unplug the power cord.
- 3** Plug the power cord back in.
- 4** Press I/\uparrow to turn on the power.

The unit is reset to factory settings. All the settings you made are cleared.

Specifications

Amplifier section

LBT-GV8

The following measured at AC 120/220/240V, 50 Hz

DIN power output (rated) 240 + 240 watts
(4 ohms at 1 kHz, DIN)

Continuous RMS power output (reference)
320 + 320 watts
(4 ohms at 1 kHz, 10% THD)

LBT-GV6

The following measured at AC 120/220/240V, 50 Hz

DIN power output (rated) 150 + 150 watts
(6 ohms at 1 kHz, DIN)

Continuous RMS power output (reference)
200 + 200 watts
(6 ohms at 1 kHz, 10% THD)

Inputs

PHONO IN:
(phono jacks) sensitivity 3 mV,
impedance 47 kilohms

MIC1/2:
(phone jack) sensitivity 1 mV,
impedance 10 kilohms

VIDEO IN:
(phono jack) sensitivity 250 mV,
impedance 47 kilohms

GAME IN:
(phono jack) sensitivity 250 mV,
impedance 47 kilohms

MD IN:
(phono jack) sensitivity 450 mV,
impedance 47 kilohms

Outputs

PHONES:
(stereo phone jack) accepts headphones of 8
ohms or more

VIDEO OUT:
(phono jack) voltage 250 mV
impedance 1 kilohm

MD OUT:
(phono jacks) voltage 250 mV
impedance 1 kilohm

FRONT SPEAKER:
LBT-GV8: accepts impedance of 4 to
16 ohms

LBT-GV6: accepts impedance of 6 to
16 ohms

Video section

Inputs

VIDEO IN (phono jack): 1 V p-p, 75 ohms
GAME IN (phono jack): 1 V p-p, 75 ohms

Outputs

VIDEO OUT (phono jack): 1 V p-p, 75 ohms
S-VIDEO OUT (4-pin/mini-DIN jack):
Y: 1 V p-p, unbalanced,
Sync negative,
C: 0.286 V p-p,
load impedance 75 ohms

VIDEO CD/CD player section

System Compact disc and digital audio system
Laser Semiconductor laser ($\lambda=780\text{nm}$), Emission duration: continuous
Wavelength: 780-790 nm
Frequency response 2 Hz – 20 kHz (± 0.5 dB)
Signal-to-noise ratio More than 90 dB
Dynamic range More than 90 dB
Video color system format NTSC, PAL
CD OPTICAL DIGITAL OUT
(Square optical connector jack, rear panel)
Wavelength: 660 nm
Output level –18 dBm

Tape player section

Recording system 4-track 2-channel stereo
Frequency response (DOLBY NR OFF) 40 – 13,000 Hz (± 3 dB), using Sony TYPE I cassette
40 – 14,000 Hz (± 3 dB), using Sony TYPE II cassette
Wow and flutter $\pm 0.15\%$ W.Peak (IEC)
 0.1% W.RMS (NAB)
 $\pm 0.2\%$ W.Peak (DIN)

Tuner section

FM stereo, FM/AM superheterodyne tuner

FM tuner section

Tuning range 87.5 – 108.0 MHz (50 kHz step)
Antenna FM lead antenna
Antenna terminals 75 ohm unbalanced
Intermediate frequency 10.7 MHz

AM tuner section

Tuning range

Middle Eastern and Philippine models:
531 – 1,602 kHz
(with the interval set at 9 kHz)

Other models:
531 – 1,602 kHz
(with the interval set at 9 kHz)
530 – 1,710 kHz
(with the interval set at 10 kHz)

Antenna AM loop antenna
Antenna terminals External antenna terminal
Intermediate frequency 450 kHz

Speakers

SS-GV6 for LBT-GV6

Speaker system 3-way BUILT IN SW, bass-reflex type, magnetically shielded type

Speaker units Super Woofer/Woofer: 17 cm dia., cone type
Tweeter: 2.5 cm dia., horn type
Rated impedance 6 ohms
Dimensions (w/h/d) Approx. 255 × 530 × 375 mm

Mass Approx. 10 kg net per speaker

SS-GV8 for LBT-GV8

Speaker system 3-way BUILT IN SW, bass-reflex type, magnetically shielded type

Speaker units Super Woofer: 22 cm dia., cone type
Woofer: 20 cm dia., cone type
Tweeter: 2.5 cm dia., horn type
Rated impedance 4 ohms
Dimensions (w/h/d) Approx. 290 × 615 × 435 mm

Mass Approx. 16 kg net per speaker

continued

Specifications (continued)

General

Power requirements 120 V, 220 V or 230 – 240
V AC, 50/60 Hz
Adjustable with voltage
selector

Power consumption

LBT-GV8 300 watts
LBT-GV6 180 watts

Dimensions (w/h/d) Approx. 355 × 425 × 450
mm

Mass :

LBT-GV8 Approx. 16.0 kg
LBT-GV6 Approx. 15.5 kg

Supplied accessories:

AM loop antenna (1)
FM lead antenna (1)
Speaker cords (2)
Speaker pads (8)
Remote commander (1)
Batteries (2)
Video connecting cable
(1)

Design and specifications are subject to change
without notice.

Glossary

Auto Pause

An automatic pause function which is activated according to the signal encoded on the disc while playing a VIDEO CD. If the CD player does not resume play for a long time, press  to resume play manually.

Menu Playback

Playback using the menu screens recorded on VIDEO CDs with PBC functions. You can enjoy simple interactive software using the menu playback function.

Playback Control (PBC)

Signals encoded on VIDEO CDs (Version 2.0) to control playback.

By using menu screens recorded on VIDEO CDs with PBC functions, you can enjoy playing simple interactive software, software with search functions, and so on.

Track

Sections of a picture or a music piece on disc. Each track is assigned a track number to help you locate the desired track.

VIDEO CD

A compact disc which contains moving pictures.

VIDEO CDs contain compact picture information using the MPEG 1 format, one of the world wide standards of digital compact technology. The picture information is compressed about 120 times. Consequently, a 12 cm VIDEO CD can contain up to 74 minutes of moving pictures.

VIDEO CDs also contain compact audio information. Sounds outside the range of human hearing are compressed while the sounds we can hear are not compressed. VIDEO CDs can hold six times the audio information of conventional audio CDs.

There are two versions for VIDEO CDs; Version 1.1 (VIDEO CDs without PBC functions):

You can play only moving pictures and sounds.

Version 2.0 (VIDEO CDs with PBC functions):

You can play still pictures and enjoy PBC functions.

This player can play both versions.

