

Micro Hi-Fi Component System

Operating Instructions

Owner's Record

The model and serial numbers are located on the bottom. Record the serial number in the space provided below. Refer to them whenever you call upon your Sony dealer regarding this product.

Model No. _____ Serial No. _____



***CMT-EP40
CMT-EP30
CMT-E301***

WARNING

To prevent fire or shock hazard, do not expose the unit to rain or moisture.

To avoid electrical shock, do not open the cabinet. Refer servicing to qualified personnel only.

Do not install the appliance in a confined space, such as a bookcase or built-in cabinet.

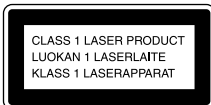

To prevent fire, do not cover the ventilation of the apparatus with newspapers, table-cloths, curtains, etc. And don't place lighted candles on the apparatus.

To prevent fire or shock hazard, do not place objects filled with liquids, such as vases, on the apparatus.



Don't throw a battery, dispose it as the injurious wastes.

NOTICE FOR THE CUSTOMERS IN THE U.S.A.

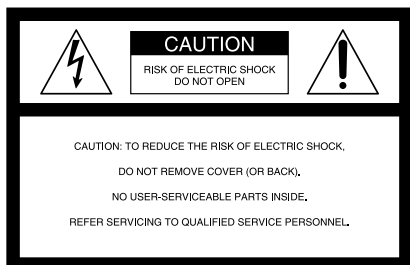

This symbol is intended to alert the user to the presence of uninsulated "dangerous voltage" within the product's enclosure that may be of sufficient magnitude to constitute a risk of electric shock to persons.



This symbol is intended to alert the user to the presence of important operating and maintenance (servicing) instructions in the literature accompanying the appliance.

CAUTION

The use of optical instruments with this product will increase eye hazard.

INFORMATION

This equipment has been tested and found to comply with the limits for a Class B digital device, pursuant to Part 15 of the FCC Rules. These limits are designed to provide reasonable protection against harmful interference in a residential installation. This equipment generates, uses, and can radiate radio frequency energy and, if not installed and used in accordance with the instructions, may cause harmful interference to radio communications. However, there is no guarantee that interference will not occur in a particular installation. If this equipment does cause harmful interference to radio or television reception, which can be determined by turning the equipment off and on, the user is encouraged to try to correct the interference by one or more of the following measures:

- Reorient or relocate the receiving antenna.
- Increase the separation between the equipment and receiver.
- Connect the equipment into an outlet on a circuit different from that to which the receiver is connected.
- Consult the dealer or an experienced radio/TV technician for help.

CAUTION

You are cautioned that any changes or modifications not expressly approved in this manual could void your authority to operate this equipment.

Note to CATV system installer:

This reminder is provided to call the CATV system installer's attention to Article 820-40 of the NEC that provides guidelines for proper grounding and, in particular, specifies that the cable ground shall be connected to the grounding system of the building, as close to the point of cable entry as practical.

NOTICE FOR THE CUSTOMERS IN CANADA

CAUTION

TO PREVENT ELECTRIC SHOCK, DO NOT USE THIS POLARIZED AC PLUG WITH AN EXTENSION CORD, RECEPTACLE OR OTHER OUTLET UNLESS THE BLADES CAN BE FULLY INSERTED TO PREVENT BLADE EXPOSURE.

About this manual

The instructions in this manual are for the CMT-EP40, CMT-EP30 and CMT-E301. CMT-EP40 is the model used for illustration purposes.

Table of Contents

Parts Identification

Main unit	4
Remote Control	5

Getting Started

Hooking up the system	6
Inserting two size AAA (R03) batteries into the remote	7
Setting the time	7

CD

Loading the CD	8
Playing the CD — Normal Play/Shuffle Play/Repeat Play	8
Programing the CD tracks — Program Play	9
Using the CD display	9

Tuner

Presetting radio stations	10
Listening to the radio — Preset Tuning	10
Using the Radio Data System (RDS)*	11

Tape

Loading a tape	12
Playing a tape	12
Recording to a tape — CD Synchro Recording/Recording Manually	13

Sound Adjustment

Adjusting the sound	14
Selecting the audio emphasis	14

Other features

Falling asleep to music — Sleep Timer	15
Waking up to music — Daily Timer	15

Additional information

Precautions	16
Troubleshooting	17
Specifications	19

* For European model only

Parts Identification

The items are arranged in alphabetical order.

Refer to the pages indicated in parentheses () for details.

Main unit

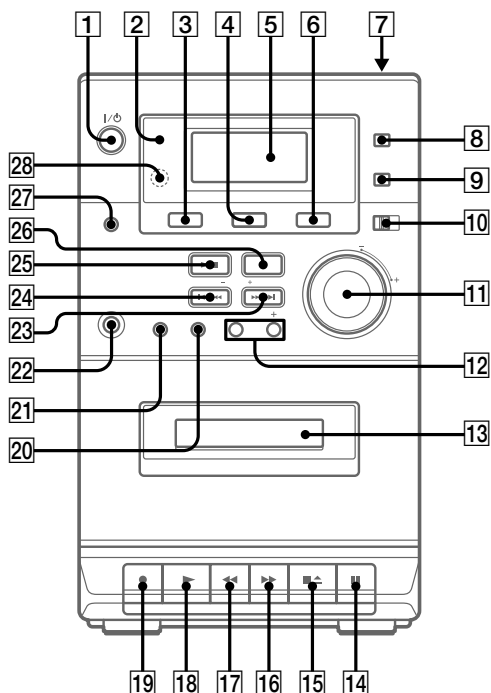

Cassette compartment **13** (12)
 CD **4** (8, 9, 13, 15)
 Display Window **5** (9, 18)
 ENTER/PGM **20** (7, 8, 9, 10, 12, 15)
 ISS **10** (13)
 MEGA BASS **8** (14)
 MONO STEREO **10** (11)
 MUSIC MENU **9** (14)
 PHONES jack **22**
 PRESET +/- **12** (10, 11)
 RDS (CMT-EP40 only) **25** (11, 12)
 REMAIN **4** (9)

Remote sensor **28**
 REPEAT **27** (8)
 SHUFFLE **21** (8)
 TAPE **3** (12)
 TIMER indicator **2** (15)
 TUNER **6** (10, 13, 15)
 TUNER DSPL (CMT-EP40 only) **26** (11)
 TUNER MEM **20** (10)
 TUNING + **23** (10, 11)
 TUNING - **24** (10, 11)
 VOLUME control **11** (15)

BUTTON DESCRIPTIONS

I/⏻ (power) **1** (6, 10)

CD

⏮⏮⏮ (go back) **24** (8, 9)
⏭⏭⏭ (go forward) **23** (8, 9)
⏮⏭ (play/pause) **25** (8, 9)
⏏ PUSH OPEN/CLOSE **7** (8)
■ (stop) **26** (8, 9)

TAPE

⏭⏭ (fast forward) **16** (12)
⏮⏭ (pause) **14** (12, 13)
▶ (play) **18** (12, 15)
● (recording) **19** (13)
◀◀ (rewind) **17** (12)
■▶ (stop/eject) **15** (12, 13)

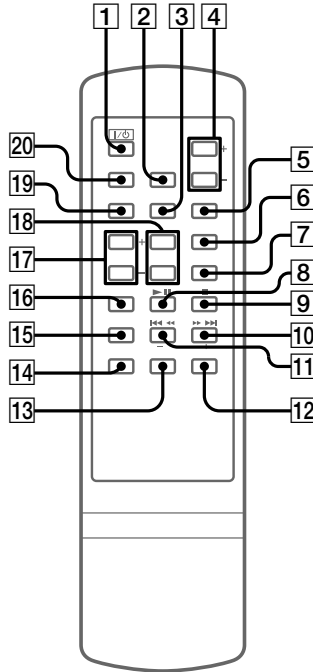

- CD/REMAIN **3** (8, 9, 13, 15)
- CLOCK/TIMER/SLEEP SET **14** (7, 15)
- MEGA BASS **2** (14)
- MUSIC MENU **20** (14)
- PRESET +/- **17** (10, 11)
- RDS (CMT-EP40 only) **16** (11, 12)
- REPEAT **12** (8)
- SHUFFLE **7** (8)
- TAPE **19** (12)
- TIMER ON/OFF **13** (15)
- TUNER/BAND **5** (10, 13, 15)
- TUNER DSPL (CMT-EP40 only) **15** (11)
- TUNER MEM/ENTER/PGM **6** (7, 8, 9, 10, 11, 15)
- TUNING/CLOCK/TIMER +/- **18** (7, 10, 11, 15)
- VOLUME +/- **4** (15)

BUTTON DESCRIPTIONS

- ▶▶ (fast forward) ▶▶▶ (go forward) **10** (8, 9)
- ◀◀ (go back) ◀◀◀ (rewind) **11** (8, 9)
- ▶|| (play/pause) **8** (8, 9)
- ⏻ (power) **1** (6, 10)
- (stop) **9** (8, 9)

Hooking up the system

Do the following procedure **1** to **2** to hook up your system using the supplied cords and accessories.

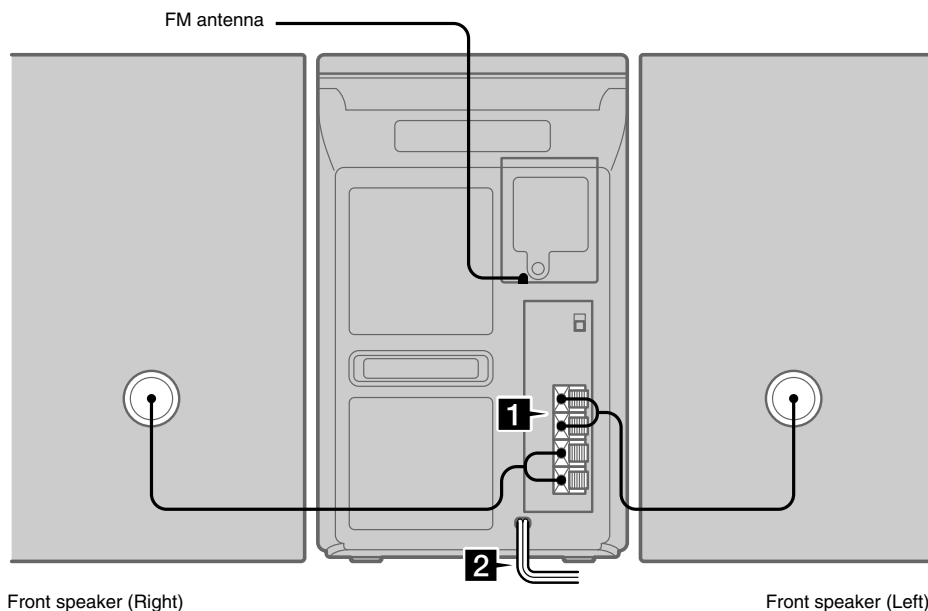

1 Connect the front speakers.

Connect the speaker cords to the SPEAKER terminals as shown below.

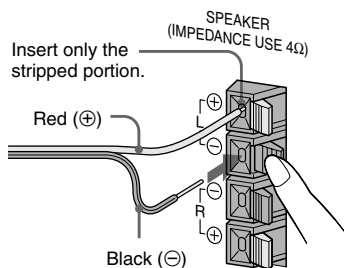

2 Connect the power cord to a wall outlet.

If the supplied adaptor on the plug does not fit your wall outlet, detach it from the plug (only for models equipped with the adaptor).

To turn on the system, press **I** / **⏻** (power).

Inserting two size AAA (R03) batteries into the remote

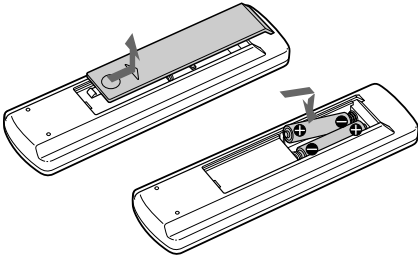

Tip

When the remote no longer operates the system, replace both batteries with new ones.

Note

If you do not use the remote for a long period of time, remove the batteries to avoid possible damage from battery leakage.

Setting the time

- 1** Turn on the system.
- 2** Press **CLOCK/TIMER/SLEEP SET** on the remote.
The clock indication appears.
- 3** Press **TUNING/CLOCK/TIMER +** or **-** on the remote repeatedly to set the time.
- 4** Press **ENTER/PGM (TUNER MEM/ENTER/PGM)** on the remote.
The clock starts working.

Tip

If you made a mistake, perform from step 2.

To change the preset time

Perform from step 2.

Note

The clock settings are canceled when you disconnect the power cord or if a power failure occurs.

Loading the CD

- 1 Press **▲** PUSH OPEN/CLOSE down to open the lid of the CD compartment.
- 2 Place a CD with the label side up on the compartment.

When you play a CD single (8 cm CD), place it on the inner circle of the compartment.

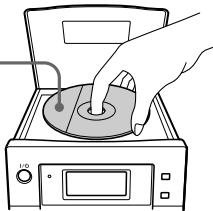

- 3 Press **▲** PUSH OPEN/CLOSE down to close the lid of the CD compartment.

Playing the CD

— Normal Play/Shuffle Play/Repeat Play

This system lets you play the CD in different play modes.

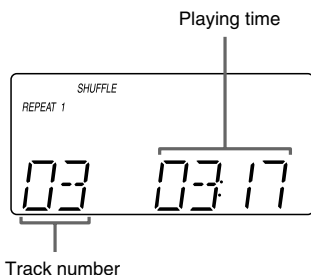

- 1 Press CD (CD/REMAIN on the remote).

- 2 Press **SHUFFLE** or **ENTER/PGM** (TUNER MEM/ENTER/PGM on the remote) repeatedly until the mode you want appears in the display.

Select	To play
No display	The CD in original order.
SHUFFLE	The tracks on the CD in random order.
PROGRAM	The tracks on the CD in the order you want them to be played. (see "Programming the CD tracks" on page 9.)

- 3 Press **▶||**.

Other Operations

To	Do this
Stop playback	Press ■ .
Pause	Press ▶ . Press again to resume play.
Select a track	Press ▶▶▶▶ (to go forward) or ◀◀◀◀ (to go back).
Find a point in a track	During play, press and hold ▶▶▶▶ (to go forward) or ◀◀◀◀ (to go back). Release it when you find the desired point.
Play repeatedly (Repeat Play)	Press REPEAT during play until "REPEAT" or "REPEAT 1" appears. REPEAT: For all the tracks on the CD. REPEAT 1: For a single track only. To cancel playing repeatedly, press REPEAT until "REPEAT" or "REPEAT 1" disappears.
Remove the CD	Press ▲ PUSH OPEN/CLOSE.

Programming the CD tracks

— Program Play

You can make a program of up to 28 tracks in the order you want them to be played.

- 1 Press CD (CD/REMAIN on the remote), then place a CD.**
- 2 Press ENTER/PGM (TUNER MEM/ENTER/PGM on the remote) repeatedly until “00 PR.01” appears in the display.**
- 3 Press ◀◀ ◀◀ or ▶▶ ▶▶ until the desired track appears in the display.**

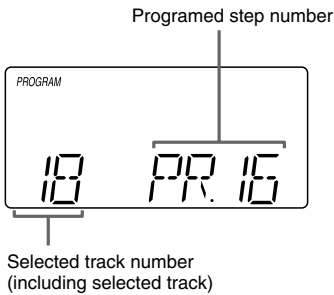

- 4 Press ENTER/PGM (TUNER MEM/ENTER/PGM on the remote).**
The track is programmed. The next program step number appears, and “PROGRAM” flashes.
- 5 To program additional tracks, repeat steps 3 to 4.**
- 6 Press ▶II.**
Program Play starts.

To	Do this
Check the total number of programmed tracks	Press ENTER/PGM (TUNER MEM/ENTER/PGM on the remote) repeatedly in stop mode. Each time you press the button, the selected track number and the programmed step number appear in the display in turn.
Cancel Program Play	Press ■ twice until “PROGRAM” disappears from the display. The program you made will be erased.

Tip

The program you made remains after Program Play finishes. When Program Play remains in the system’s memory, “PROGRAM” flashes. To play the same program again, press CD (CD/REMAIN on the remote) and ENTER/PGM (TUNER MEM/ENTER/PGM on the remote), then press ▶II.

Using the CD display

Press REMAIN (CD/REMAIN on the remote) repeatedly.

The display changes as follows:

During normal play

Elapsed playing time on the current track →

Remaining time on the current track →

Remaining time on the current CD →

Elapsed playing time on the current track → ...

Presetting radio stations

You can preset up to 24 stations for FM and AM.

1 Press TUNER (TUNER/BAND on the remote) repeatedly to select FM or AM.

2 Press and hold TUNING (TUNING/CLOCK/TIMER on the remote) + or – until the frequency indication starts to change, then release it.

Scanning stops automatically when the system tunes in a station. “STEREO” (for a stereo program) appears.

If it doesn't stop automatically, press TUNING (TUNING/CLOCK/TIMER on the remote) + or – repeatedly to tune in a station manually.

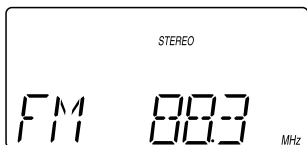

3 Press TUNER MEM (TUNER MEM/ENTER/PGM on the remote).

A preset number appears in the display. The stations are stored from preset number 1.

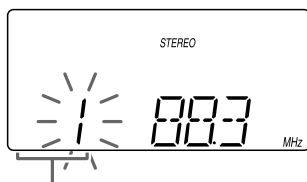

Preset number

4 Press PRESET + or – until the preset number you want for the station flashes.

5 Press ENTER/PGM (TUNER MEM/ENTER/PGM on the remote). The station is stored.

6 Repeat steps 2 to 5 to store other stations.

To tune in a station with a weak signal

Press TUNING (TUNING/CLOCK/TIMER on the remote) + or – repeatedly in step 2 to tune in the station manually.

To set another station to an existing preset number

Start over from step 1. After step 3, press PRESET + or – repeatedly to select the preset number where you want to store the other station and then press ENTER/PGM (TUNER MEM/ENTER/PGM on the remote).

You can preset a new station in the selected preset number.

To change the AM tuning interval (except for the European and Middle Eastern models)

Disconnect the power cord from the wall outlet first, and then set the AM FREQ STEP switch at the rear to 9 kHz or 10 kHz.

Tip

The preset stations are retained for half a day even if you unplug the power cord or if a power failure occurs.

Listening to the radio

— Preset Tuning

Preset radio stations in the tuner's memory first.

Press PRESET + or – repeatedly to tune in the desired preset station.

The preset number appears in the display for a few seconds.

To	Do this
Turn off the radio	Press I/⏻.

To listen to non-preset radio stations

Use manual or automatic tuning. For manual tuning, press TUNER (TUNER/BAND on the remote) repeatedly to select FM or AM and then press TUNING (TUNING/CLOCK/TIMER on the remote) + or – repeatedly.

For automatic tuning, press and hold TUNING (TUNING/CLOCK/TIMER on the remote) + or –.

Tips

- When an FM program is noisy, set MONO STEREO to MONO so that “MONO” appears in the display. There will be no stereo effect, but the reception will improve.
- To improve broadcast reception, adjust the antenna (for FM) or reorient the main unit itself (for AM).
- While listening to the preset radio stations, you can switch the display between the preset number and the frequency by pressing TUNER DSPL (CMT-EP40 only).

Using the Radio Data System (RDS)

(CMT-EP40, European model only)

What is the Radio Data System?

Radio Data System (RDS) is a broadcasting service that allows radio stations to send additional information along with the regular program signal. This tuner offers convenient RDS features like station name display and location of stations by program type. RDS is available only on FM stations.*

Note

RDS may not work properly if the station you are tuned in is not transmitting the RDS signal properly or if the signal strength is weak.

* Not all FM stations provide RDS service, nor do they provide the same types of services. If you are not familiar with the RDS system, check with your local radio stations for details on RDS services in your area.

Receiving RDS broadcasts

Simply select a station from the FM band. When you tune in a station that provides RDS services, “RDS” appears in the display.

To check the RDS information

Each time you press RDS, the display changes as follows:

Station name* → RDS TEXT* → Program type* → Preset number → Frequency → Station name* → ...

* If the RDS broadcast is not received, the station name, RDS TEXT and program type may not appear in the display.

Locating a station by program type (PTY)

You can locate a station you want by selecting a program type. The system tunes in the type of programs currently being broadcast from the RDS stations stored in the tuner’s preset memory.

The types of programs include NEWS, AFFAIRS (current news), INFO, SPORT, EDUCATE (education programs), DRAMA, CULTURE, SCIENCE, VARIETY (interviews, games and comedy), POP, ROCK, LIGHT M, CLASSICS, OTHER M, and NO TYPE (any programs not defined above).

- 1 Press RDS while listening to the radio.**
- 2 Press PRESET + or – repeatedly to select the program type you want.**
- 3 Press and hold TUNING (TUNING/CLOCK/TIMER on the remote) + or –.**
When the tuner receives a program, “PTY” flashes.

Note

When the program type you select is not currently being broadcast, the system tunes back in the FM program that was tuned before you pressed RDS.

To cancel PTY

Press TUNER DSPL until “PTY” disappears from the display.

continued

Using the Radio Data System (RDS) (continued)

Listening to a traffic information

When the tuner receives traffic information signal, "TRAFFIC INFO" will flash in the display.

- 1** Press RDS repeatedly until "INFO OFF" or "INFO ON" appears while listening to an FM program.
- 2** Press ENTER/PGM (TUNER MEM/ENTER/PGM on the remote) to set "INFO ON".

Setting the time to the broadcast

You can set the time to the clock information received.

- 1** Press RDS repeatedly until "SYNC OFF" or "SYNC ON" appears while listening to an FM program.
- 2** Press ENTER/PGM (TUNER MEM/ENTER/PGM on the remote) to set "SYNC ON".

Loading a tape

- 1** Press TAPE.
- 2** Press ■▲.
- 3** Insert a tape in deck with the side you want to play/record facing forward.

Insert with the side you want to play/record facing forward.

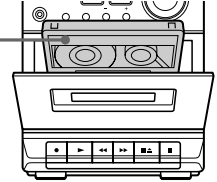

Playing a tape

You can use TYPE I (normal) tape.

- 1** Load a recorded tape.
- 2** Press TAPE.
- 3** Press ►.

To	Press
Stop play	■▲
Pause	 Press again to resume play.
Fast-forward or rewind	◀◀ or ▶▶
Remove the cassette	■▲

Recording to a tape

— CD Synchro Recording/Recording Manually

You can record from a CD or radio. You can use TYPE I (normal) tape.

Steps	Recording from a CD (CD Synchro Recording)	Recording from the radio
1	Load a blank tape.	
2	Press CD (CD/REMAIN on the remote).	Press TUNER (TUNER/BAND on the remote).
3	Load the CD you want to record.	Tune in the station you want to record.
4	Press ●.	Press II and ●. The deck stands by for recording. Press II again.

Tape

To stop recording

Press ■▲.

Tips

- For recording from a CD to a tape, you can press I◀◀ ◀◀ or ▶▶ ▶▶I to select tracks before step 4.
- When an AM program is noisy, set ISS to select the position that decreases the noise the most.

Adjusting the sound

Press MEGA BASS.

“MEGA BASS” appears in the display. To return to normal sound, press the button again.

Selecting the audio emphasis

Selecting the preset effect from the music menu

Press MUSIC MENU repeatedly to select the preset effect you desire.

Each time you press the button, the display changes as follows:

ROCK → POP → JAZZ → No display →
ROCK → ...

Falling asleep to music

— Sleep Timer

You can set the system to turn off after certain amount of time, so that you can fall asleep to music.

- 1 Press **CLOCK/TIMER/SLEEP SET** on the remote repeatedly until “**SLEEP OFF**” appears in the display.
- 2 Press **TUNING/CLOCK/TIMER + or –** on the remote to select the minutes until the player goes off automatically.

Every time you press the button, the minute display (the turn-off time) changes as follows:

90 ↔ 80 ↔ 70 ↔ ... ↔ 10 ↔ OFF

- 3 Press **ENTER/PGM (TUNER MEM/ENTER/PGM)** on the remote).

To	Do this
Change the time to turn off	Start over from step 1.
Cancel the Sleep Timer function	Start over from step 1 and select “OFF” on step 2.

Waking up to music

— Daily Timer

You can wake up to music at a preset time every day. Make sure you have set the clock (see page 7).

- 1 Prepare the sound source you want to play.
 - CD: Load a CD.
 - Radio: Tune in the preset station you want (see page 10).
- 2 Adjust the volume.

- 3 Press **CLOCK/TIMER/SLEEP SET** on the remote repeatedly until “**ON 0:00**” appears in the display.
- 4 Set the time to start playback using **TUNING/CLOCK/TIMER + or –** on the remote.
- 5 Press **ENTER/PGM (TUNER MEM/ENTER/PGM)** on the remote).
- 6 Press **CLOCK/TIMER/SLEEP SET** on the remote repeatedly until “**OFF 0:00**” appears in the display.
- 7 Set the time to stop playback using **TUNING/CLOCK/TIMER + or –** on the remote.
- 8 Press **ENTER/PGM (TUNER MEM/ENTER/PGM)** on the remote).
- 9 Press **CD (CD/REMAIN)** on the remote) or **TUNER (TUNER/BAND)** on the remote) depending on the sound source you want to play.
- 10 Turn off the power and press **TIMER ON/OFF** on the remote.
The **TIMER** indicator lights up.

To	Do this
Check the setting	Press CLOCK/TIMER/SLEEP SET on the remote repeatedly.
Change the setting	Start over from step 1.
To cancel the timer operation	Press TIMER ON/OFF on the remote.

Precautions

On operating voltage

Before operating the system, check that the operating voltage of your system is identical with the voltage of your local power supply.

On safety

- The unit is not disconnected from the AC power source (mains) as long as it is connected to the wall outlet, even if the unit itself has been turned off.
- Unplug the system from the wall outlet (mains) if it is not to be used for an extended period of time. To disconnect the cord (mains lead), pull it out by the plug. Never pull the cord itself.
- Should any solid object or liquid fall into the component, unplug the stereo system and have the component checked by qualified personnel before operating it any further.
- The AC power cord must be changed only at a qualified service shop.

On placement

- Place the unit in a location with adequate ventilation to prevent heat build-up the unit.
- Do not place the unit in an inclined position.
- Do not place the unit in locations where it is;
 - Extremely hot or cold
 - Dusty or dirty
 - Very humid
 - Vibrating
 - Subject to direct sunlight.

On heat buildup

- Although the unit heats up during operation, this is not malfunction
- Place the unit in a location with adequate ventilation to prevent heat build-up in the unit.

If you continuously use this unit at a large volume, the cabinet temperature of the top, side and bottom rises considerably. To avoid burning yourself, do not touch the cabinet.

To prevent a malfunction, do not cover the ventilation hole for the cooling fan.

On operation

- If the system is brought directly from a cold to a warm location, or is placed in a very damp room, moisture may condense on the lens inside the CD player. Should this occur, the system will not operate properly. Remove the CD and leave the system turned on for about an hour until the moisture evaporates.
- When you move the system, take out any discs.

If you have any questions or problems concerning your stereo system, please consult your nearest Sony dealer.

Notes on CDs

- Before playing, clean the CD with a cleaning cloth. Wipe the CD from the center out.
- Do not use solvents.
- Do not expose the CD to direct sunlight or heat sources.
- Discs with non-standard shapes (e.g., heart, square, star) cannot be played on this system. Attempting to do so may damage the system. Do not use such discs.

Note on CD-R/CD-RW playback

Discs recorded on CD-R/CD-RW drives may not be played back because of scratches, dirt, recording condition or the drive's characteristics. Besides, the discs, which are not yet finalized at the end of recording cannot be played back.

Cleaning the cabinet

Use a soft cloth slightly moistened with mild detergent solution.

To save a tape permanently

To prevent a tape from being accidentally recorded over, break off the cassette tab from side A or B as illustrated.

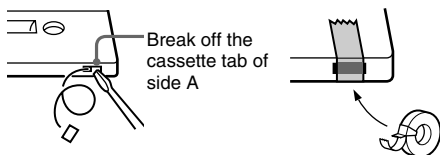

If you later want to reuse the tape for recording, cover the broken tab with adhesive tape.

Before placing a cassette in the tape deck

Take up any slack in the tape. Otherwise the tape may get entangled in the parts of the tape deck and become damaged.

When using a tape longer than 90 minutes

The tape is very elastic. Do not change the tape operations such as play, stop, and fast-winding (etc.) frequently. The tape may get entangled in the tape deck.

Cleaning the tape heads

Clean the tape heads after every 10 hours of use. Make sure to clean the tape heads before you start an important recording or after playing an old tape. Use separately sold dry-type or wet-type cleaning cassette. For details, refer to the instructions of the cleaning cassette.

Demagnetizing the tape heads

Demagnetize the tape heads and the metal parts that have contact with the tape every 20 to 30 hours of use with a separately sold demagnetizing cassette. For details, refer to the instructions of the demagnetizing cassette.

Troubleshooting

If you have any problem using this system, use the following check list.

First, check that the power cord is connected firmly and the speakers are connected correctly and firmly.

Should any problem persist, consult your nearest Sony dealer.

General

The clock setting/radio presetting/timer is canceled.

- The power cord is disconnected or a power failure occurs longer than half a day. Redo the following:
 - “Setting the time” on page 7
 - “Presetting radio stations” on page 10
- If you have set the timer, also redo “Waking up to music” on page 15.

There is no sound.

- Turn VOLUME clockwise and hold.
- The headphones are connected.
- Insert only the stripped portion of the speaker cord into the SPEAKER terminal. Inserting the vinyl portion of the speaker cord will obstruct the speaker connections.

There is severe hum or noise.

- A TV or VCR is placed too close to the stereo system. Move the stereo system away from the TV or VCR.

The clock indication does not show the correct time.

- A power interruption occurred. Set the clock and timer settings again.

The timer does not function.

- Set the clock correctly.
- When you used the Sleep Timer, the Daily Timer will not turn on the system until the Sleep Timer turns it off.

continued

Troubleshooting (continued)

The remote does not function.

- There is an obstacle between the remote and the system.
 - The remote is not pointing in the direction of the system's sensor.
 - The batteries have run down. Replace the batteries.
-

The color irregularity on a TV screen persists.

- Turn off the TV set once, then turn it on after 15 to 30 minutes. If the color irregularity still persists, place the speakers farther away from the TV set.
-

Speakers

Sound comes from one channel or unbalanced left and right volume.

- Check the speaker connection and speaker placement.
-

Sound lacks bass.

- Check that the speaker's + and – terminals are connected correctly.
-

CD Player

The CD compartment does not close.

- The CD is not placed properly.
-

The CD will not play.

- The CD is not lying flat in the CD compartment.
 - The CD is dirty.
 - The CD is inserted label side down.
 - Moisture condensation has built up. Remove the CD and leave the system turned on for about an hour until the moisture evaporates.
-

Tape Deck

The tape does not record.

- No tape in the cassette compartment.
 - The tab has been removed from the cassette.
 - The tape has reeled to the end.
-

The tape does not record nor play or there is a decrease in sound level.

- The heads are dirty. Clean them (see "Cleaning the tape heads" on page 17).
 - The record/playback heads are magnetized. Demagnetize them (see "Demagnetizing the tape heads" on page 17).
-

The tape does not erase completely.

- The record/playback heads are magnetized. Demagnetize them (see "Demagnetizing the tape heads" on page 17).
-

There is excessive wow or flutter, or the sound drops out.

- The capstans or pinch rollers are dirty. Clean them (see "Cleaning the tape heads" on page 17).
-

Noise increases or the high frequencies are erased.

- The record/playback heads are magnetized. Demagnetize them (see "Demagnetizing the tape heads" on page 17).
-

Tuner

Noise is heard.

- For FM, move the antenna to reduce the noise. For AM, reorient the main unit itself to reduce the noise.
-

A stereo FM program cannot be received in stereo.

- Set MONO STEREO so that "STEREO" appears.
-

Messages

The following message may appear in the display during operations.

NO DISC

- There is no disc on the CD compartment.
-

Specifications

Amplifier section

AUDIO POWER SPECIFICATIONS: (U.S.A. model only)

POWER OUTPUT AND TOTAL HARMONIC DISTORTION:

with 4 Ω loads both channels driven, from 120 - 10,000 Hz; rates 5 W per channel minimum RMS power, with no more than 10% total harmonic distortion from 250 mW to rated output.

Canadian model:

Continuous RMS power output (reference)
5 + 5 W
(4 Ω at 1 kHz, 10% THD)

European model:

DIN power output (rated) 4.5 + 4.5 W
(4 Ω at 1 kHz, DIN)
Continuous RMS power output (reference)
5 + 5 W
(4 Ω at 1 kHz, 10% THD)
Music power output (reference)
13 + 13 W

Other model:

The following measured at AC 230 V, 50/60 Hz
DIN power output (rated) 4.5 + 4.5 W
(4 Ω at 1 kHz, DIN)
Continuous RMS power output (reference)
5 + 5 W
(4 Ω at 1 kHz, 10% THD)

Outputs
PHONES: Accepts headphones of
(stereo mini jack) 8 Ω or more
SPEAKER: Accepts impedance of 4 to
16 Ω

CD player section

System Compact disc and digital
audio system
Laser Semiconductor laser
($\lambda=780$ nm)
Emission duration:
continuous
Frequency response 20 Hz - 20 kHz (± 0.5 dB)

Tape player section

Recording system 4-track 2-channel stereo
Frequency response 50 - 13 000 Hz (± 3 dB),
using Sony TYPE I
cassette
Wow and flutter $\pm 0.15\%$ W.Peak (IEC)
0.1% W.RMS (NAB)
 $\pm 0.2\%$ W.Peak (DIN)

Tuner section

FM stereo, FM/AM superheterodyne tuner

FM tuner section

Tuning range 87.5 - 108.0 MHz
Antenna FM lead antenna
Intermediate frequency 10.7 MHz

AM tuner section

Tuning range
Pan-American model: 530 - 1 710 kHz
(with the interval set at
10 kHz)
531 - 1 602 kHz
(with the interval set at
9 kHz)

European model:

531 - 1 602 kHz
(with the interval set at
9 kHz)

Other models:

531 - 1 602 kHz
(with the interval set at
9 kHz)
530 - 1 710 kHz
(with the interval set at
10 kHz)

Antenna Built-in ferrite bar antenna
Intermediate frequency 450 kHz

Speaker

Speaker system Bass-reflex type
Speaker units Full range 10 cm, cone
type
Nominal impedance 4 Ω
Dimensions (w/h/d) Approx. 145 \times 238 \times 171 mm
Mass Approx. 1.4 skg net per
speaker

continued

Specifications (continued)

General

Power requirements

North American model:	120 V AC, 60 Hz
European model:	230 V AC, 50/60 Hz
Australian model:	230 V AC, 50/60 Hz
Mexican model:	120 V AC, 60 Hz
Argentine model:	220 V AC, 50/60 Hz
Taiwan model:	110 V AC, 60 Hz
Other models:	230 V AC, 50/60 Hz

Power consumption

U.S.A. model:	25 W
Canadian model:	25 W
European model:	30 W
	0.9 W (in the standby mode)
Other models:	30 W

Dimensions (w/h/d): Approx. 145 × 238 × 238 mm

Mass: Approx. 2.8 kg

Supplied accessories: Remote Commander (1)
 Batteries (2)

Design and specifications are subject to change without notice.