

# *Micro Hi-Fi Component System*

---

## Operating Instructions

## Owner's Record

The model and serial numbers are located on the rear panel of the unit. Record the serial number in the space provided below. Refer to them whenever you call upon your Sony dealer regarding this product.

Model No. \_\_\_\_\_ Serial No. \_\_\_\_\_



## *CMT-EX100*

# Warning

## To prevent fire or shock hazard, do not expose the unit to rain or moisture.

To avoid electrical shock, do not open the cabinet. Refer servicing to qualified personnel only.

To prevent fire, do not Cover the ventilation of the apparatus with news papers, table-cloths, curtains, etc. And don't place lighted candles on the apparatus.

To prevent fire or shock hazard, do not place objects filled with liquids, such as vases, on the apparatus.

Do not install the appliance in a confined space, such as a bookcase or built-in cabinet.

This appliance is classified as a CLASS 1 LASER product.

This label is located on the rear exterior.



The following caution label is located inside the unit.

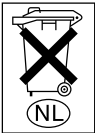

Don't throw a battery, dispose it as the injurious wastes.

# Table of Contents

## Parts Identification

Main unit .....	4
Remote Control .....	5

## Getting Started

Hooking up the system .....	6
Replacing the battery in the remote .....	8
Setting the time .....	8

## CD

Loading a CD .....	9
Playing a CD	
— Normal Play/Shuffle Play/ Repeat Play .....	9
Programing CD tracks	
— Program Play .....	11
Using the CD display .....	12

## Tuner

Presetting radio stations .....	12
Listening to the radio	
— Preset Tuning .....	13
Using the Radio Data System (RDS)* ....	14

## Sound Adjustment

Adjusting the sound	
— DSG .....	14

## Timer

Falling asleep to music	
— Sleep Timer .....	15
Waking up to music	
— Daily Timer .....	15

## Optional Components

Hooking up the optional components .....	16
--	----

## Additional Information

Precautions .....	17
Troubleshooting .....	18
Messages .....	20
Specifications .....	21

\* European model only

## Parts Identification

The items are arranged in alphabetical order. Refer to the pages indicated in parentheses ( ) for details.

### Main unit

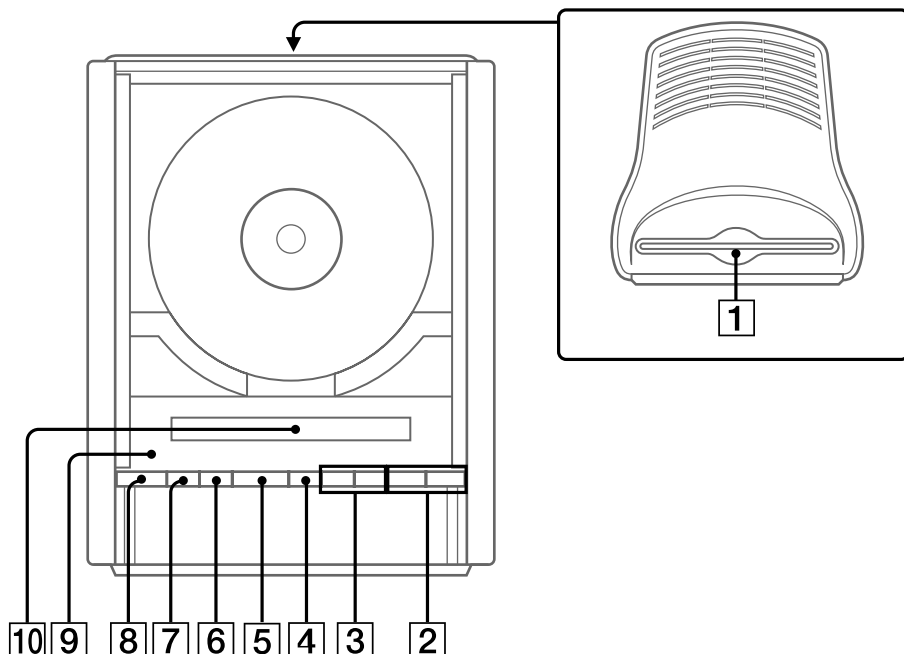

Display window **10**  
FUNCTION **7** (9, 16)  
OPEN/CLOSE ▲ **1** (9)  
Remote sensor **9**  
TUNER/BAND **6** (12)  
TUNING +/- **3** (12)  
VOL +/- **2**

#### BUTTON DESCRIPTIONS

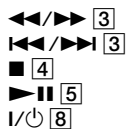



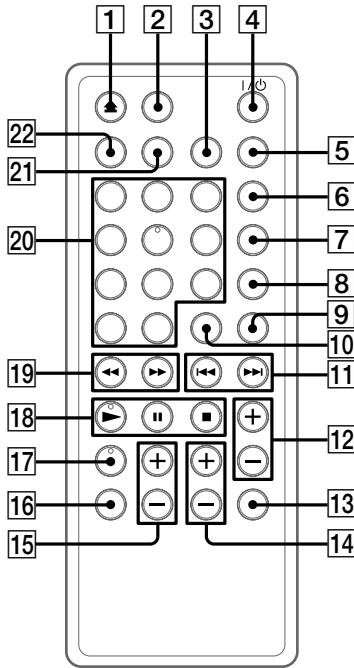

# Remote Control



- BASS +/- **15** (14)
- CD **18** (9)
- CLOCK/TIMER SELECT **6**  
(16)
- CLOCK/TIMER SET **7** (8, 15)
- DISPLAY **5** (8, 12, 14)
- DSG **13** (14)
- ENTER **8** (8, 11, 12, 15)
- FM MODE **3** (13)
- FUNCTION **22** (9, 16)

- MEMORY **9** (12)
- Number buttons **20** (10)
- OPEN/CLOSE **1** (9)
- PC/TAPE **10** (16)
- PLAY MODE **21** (9, 11)
- REPEAT **3** (10)
- SLEEP **2** (15)
- SURROUND **16** (14)
- TREBLE +/- **14** (14)
- TUNER BAND **17** (12)
- TUNING MODE **21** (12)
- VOL +/- **12**

## BUTTON DESCRIPTIONS

-  **4**
-  **11**
-  **11**
-  **11**
-  **18**
-  **18**
-  **19**
-  **19**

## Hooking up the system

Perform the following procedure **1** to **6** to hook up your system using the supplied cords and accessories.

The front cover is made of tempered glass. Please remember to handle this system carefully.

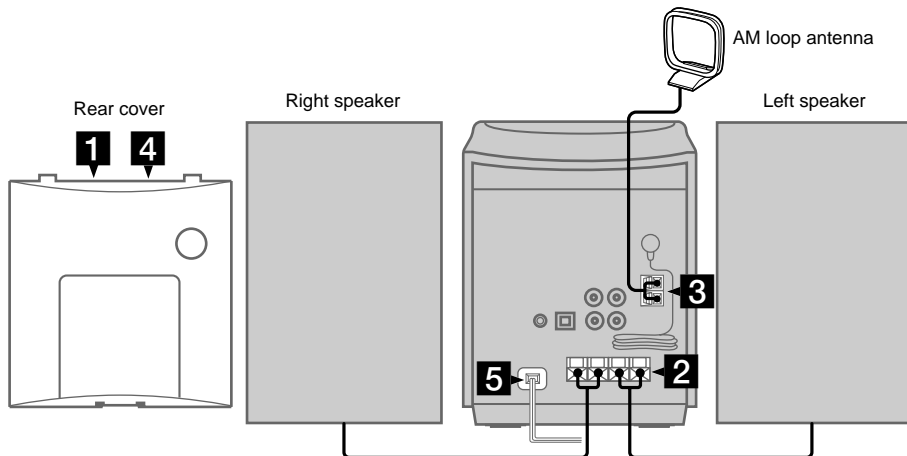

### **1** Remove the rear cover.

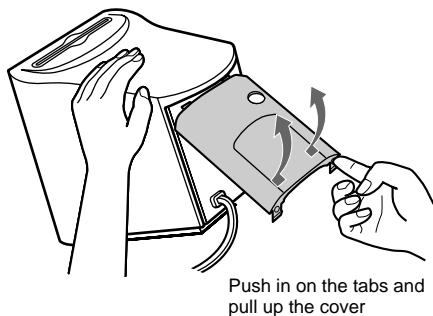

### **2** Connect the speakers.

Connect the speaker cords to the SPEAKER terminals as shown below.

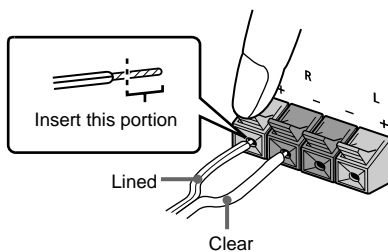

**3 Connect the AM antenna.**

Set up the AM loop antenna, then connect it.

Connect the white cord to the  $\text{h}$  terminal, and the red cord to the other terminal.

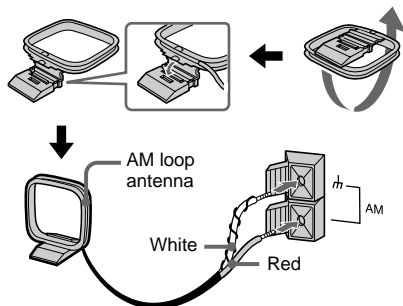
**4 Reinstall the rear cover.**

Put the wires through the hole at the bottom of the rear cover.

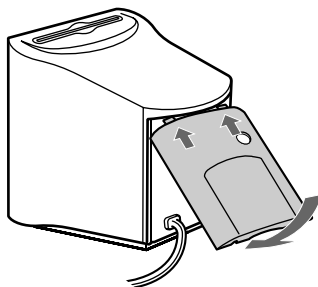
**5 Connect the power cord to the wall outlet after you complete all the connections.****6 To use the remote, pull out the insulating sheet to allow power to flow from the battery.**

The remote already contains a battery.

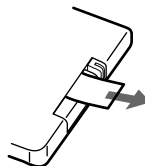

Note on the glass cover of CD player  
The CD player cover is made of tempered glass. Under normal conditions, this tempered glass is more shock resistant and able to bear more weight than ordinary glass. This glass, however, may shatter if it receives a sharp blow or if it is scratched.

To connect optional components  
See "Optional Components" on page 16.

## Replacing the battery in the remote

- 1 Slide out and remove the battery case.

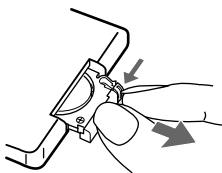

- 2 Insert a new lithium battery CR2025 with the + side facing up.

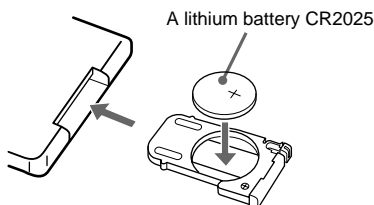

- 3 Slide the battery case back in.

### Tip

When the remote no longer operates the system, replace the battery with a new one.

### Notes

- If you do not use the remote for a long period of time, remove the battery to avoid possible damage from battery leakage.
- Keep the lithium battery out of the reach of children. Should the battery be swallowed, immediately consult a doctor.

### CAUTION

Danger of explosion if battery is incorrectly replaced. Replace only with the same or equivalent type recommend by the manufacturer. Discard used batteries according to the manufacturer's instructions.

### WARNING

Battery may explode if mistreated.  
Do not recharge, disassemble or dispose of in fire.

## Setting the time

- 1 Turn on the system.
- 2 Press **CLOCK/TIMER SET** on the remote.  
Proceed to step 4 when you set the clock for the first time.
- 3 Press **◀** or **▶** repeatedly to select "**CLOCK SET**", then press **ENTER** on the remote.  
The day indication flashes.
- 4 Press **◀** or **▶** repeatedly to set the day, then press **ENTER** on the remote.  
The hour indication flashes.
- 5 Press **◀** or **▶** repeatedly to set the hour, then press **ENTER** on the remote.  
The minute indication flashes.
- 6 Press **◀** or **▶** repeatedly to set the minute, then press **ENTER** on the remote.  
The clock starts working.

### Tip

If you made a mistake or want to change the time, start over from step 1.

## Turning off the clock display in standby mode

### Press **DISPLAY** on the remote while the system is off.

To turn on the clock display, press **DISPLAY** on the remote again.

### Notes

- When the Daily Timer is set, you cannot turn off the clock display.
- The clock display will appear when you set the Daily Timer during turning off the display.



## Loading a CD

- 1 Touch **OPEN/CLOSE**  $\blacktriangle$  (or press **OPEN/CLOSE**  $\blacktriangle$  on the remote) to raise the disc tray.

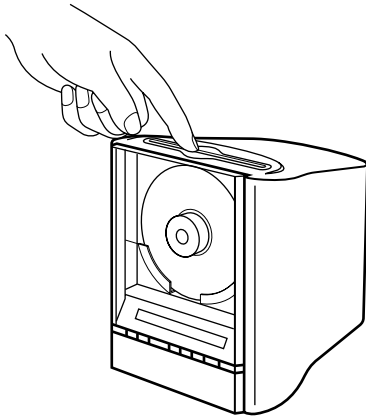

- 2 Place a CD vertically in the disc tray.

With the label side facing front. When you play a CD single (8 cm CD), use the optional adaptor.

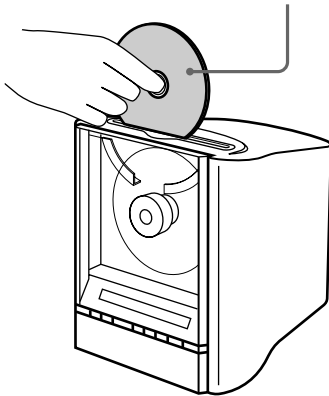

- 3 Touch **OPEN/CLOSE**  $\blacktriangle$  (or press **OPEN/CLOSE**  $\blacktriangle$  on the remote) again to lower the disc tray.

### Note

Do not touch the playing side of the CD with your fingers, as this may damage CD or cause the CD to load prematurely.

## Playing a CD

### — Normal Play/Shuffle Play/Repeat Play

This system lets you play the CD in different play modes.

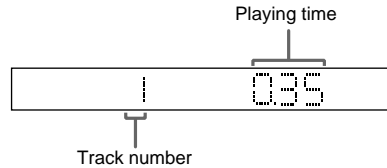

- 1 Press **FUNCTION** repeatedly to switch the function to **CD**.
- 2 Press **PLAY MODE** on the remote repeatedly until the mode you want appears in the display.

Select	To play
No display (Normal Play)	All the tracks in original order.
SHUF (Shuffle Play)	All the tracks in random order.
PGM (Program Play)	All the tracks in the order you want them to be played (see "Programing CD tracks" on page 11).

- 3 Press **▶||** (or **CD ▶** on the remote).

continued

## Playing a CD (continued)

### Other Operations

To	Do this
Stop play	Press ■.
Pause	Press ►   (or    on the remote). Press again to resume play.
Select a track	Press ◀◀ or ▶▶ repeatedly until you find the desired track.
Find a point in a track	Keep pressing ◀◀ or ▶▶ during play and release it at the desired point.
Remove a CD	Touch OPEN/CLOSE ▲ (or press OPEN/CLOSE ▲ on the remote).
Play repeatedly (Repeat Play)	Press REPEAT on the remote during play until "REP" or "REP 1" appears. REP: For all the tracks on the CD. REP 1*: For a single track only. To cancel playing repeatedly, press REPEAT on the remote until "REP" or "REP 1" disappears.

\* You cannot repeat only one track during Shuffle Play and Program Play.

#### Tip

If you press a number button on the remote, the track corresponding to the pressed number on the disc starts playing (**Track Direct Play**).

To enter track number 10 or over on the remote

**1** Press >10.

**2** Enter the corresponding number buttons.

To enter 0, press 10/0 instead.

Example:

To enter track number 30, press >10, then 3 and 10/0.

#### Notes

- Do not forcibly press the disc down with your finger, as this may cause CD player trouble. Furthermore, do not obstruct the ejecting CD. Be sure to touch OPEN/CLOSE ▲ (or press OPEN/CLOSE ▲ on the remote) to lower the disc tray.
- The disc tray will not operate if you touch OPEN/CLOSE ▲ while wearing gloves. Touch OPEN/CLOSE ▲ with bare hands or press OPEN/CLOSE ▲ on the remote.

# Programing CD tracks

## — Program Play

You can make a program of up to 24 tracks.

- 1 Press **FUNCTION** repeatedly to switch the function to CD.
- 2 Press **PLAY MODE** on the remote repeatedly until “PGM” appears.
- 3 Press **I◀◀** or **▶▶I** repeatedly until the desired track number appears.

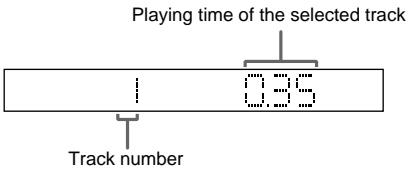

- 4 Press **ENTER** on the remote.  
The track is programmed.  
The total playing time of the program and the number of the last programmed track are displayed.
- 5 To program additional tracks, repeat steps 3 and 4.
- 6 Press **▶▶II** (or **CD ▶▶** on the remote).

## Other Operations

To	Do this
Cancel Program Play	Press <b>PLAY MODE</b> on the remote repeatedly until “PGM” and “SHUF” disappear.
Clear the entire program	Press <b>■</b> in stop mode.
Select the desired track using number buttons	Press number buttons on the remote instead of performing steps 3 to 5.

### Tips

- The program you made remains after Program Play finishes. To play the same program again, press **▶▶II** (or **CD ▶▶** on the remote).
- When the total playing time has exceeded 100 minutes, the time is not displayed and the total number of programmed tracks is displayed.

## Using the CD display

### Press DISPLAY on the remote repeatedly.

When a CD TEXT disc is loaded, you can check the information recorded on the disc, such as the titles. The display changes cyclically as follows:

During normal play

Track number and elapsed playing time on the current track → Track number and remaining time on the current track → Remaining time on the CD → Track title of the current track\* → Clock

In stop mode

Total number of tracks and total playing time → CD disc title\* → Artist name\* → Clock

\* If a CD that has no title is loaded, nothing appears. When the CD contains more than 20 tracks, CD TEXT is not displayed from track 21 on.

## Presetting radio stations

You can preset 20 stations for FM and 10 stations for AM.

**1 Press TUNER/BAND (or TUNER BAND on the remote) repeatedly to select “FM” or “AM”.**

**2 Press TUNING MODE on the remote repeatedly until “AUTO” appears.**

**3 Press TUNING – or + (or – or + on the remote).**

The frequency indication changes and the scanning stops when the system tunes in a station. “TUNED” and “STEREO” (for a stereo program) appear.

**4 Press MEMORY on the remote.**

A preset number flashes.

Proceed to step 5 while the preset number is flashing. If the system is not operated for more than 16 seconds, the preset number disappears and the system returns to the status of step 2. If this happens, start over from step 3.

**5 Press ◀◀ or ▶▶ to select the preset number you want.**

**6 Press ENTER on the remote.**

The station is stored.

**7 Repeat steps 1 to 6 to store other stations.**

To stop scanning

Press TUNING MODE on the remote.

To tune in a station with a weak signal

Press TUNING MODE on the remote repeatedly in step 2. "MANUAL" appears. Then press TUNING – or + (or – or + on the remote) repeatedly to tune in the station manually and continue from step 4.

To change the preset number

Start over from step 1.

To change the AM tuning interval (except for the European model)

The AM tuning interval is factory-set to 9 kHz (10 kHz in some areas). To change the AM tuning interval, tune in any AM station first, then turn off the system. While holding TUNING + on the system, turn the system back on. When you change the interval, all the AM preset stations are erased. To reset the interval, repeat the same procedure.

Tips

- The preset stations are retained for about a week even if you disconnect the power cord or if a power failure occurs.
- When a new station is memorized, the station formerly memorized at that preset number is erased.

## Listening to the radio

### — Preset Tuning

Preset radio stations in the tuner's memory first (see "Presetting radio stations" on page 12).

- 1 Press TUNER/BAND (or TUNER BAND on the remote) repeatedly to select "FM" or "AM".
- 2 Press TUNING MODE on the remote repeatedly until "PRESET" appears.
- 3 Press ◀◀ or ▶▶ to select the desired preset station (or RDS station name\*).  
\* European model only

### Listening to non-preset radio stations

- Press TUNING MODE on the remote repeatedly in step 2. "MANUAL" appears. Then press TUNING – or + (or – or + on the remote) repeatedly to tune in the desired station (**Manual Tuning**).
- Press TUNING MODE on the remote repeatedly until "AUTO" appears in step 2 then press TUNING – or + (or – or + on the remote). The frequency indication changes and the scanning stops when the system tunes in a station (**Automatic Tuning**).

To cancel Automatic Tuning

Press TUNING MODE on the remote.

Tips

- If noise is heard while listening to an FM station, remove the FM antenna from the rear panel and place the antenna outside the cabinet.
- To improve broadcast reception, adjust the supplied antennas, or connect a commercially available external antenna.
- When an FM stereo program has static noise, press FM MODE on the remote repeatedly until "MONO" appears. There will be no stereo effect, but the reception will improve.

## Using the Radio Data System (RDS)

(European model only)

### What is the Radio Data System?

Radio Data System (RDS)\* is a broadcasting service that allows radio stations to send additional information along with the regular program signal.

Note

RDS may not work properly if the station you tuned in is not transmitting the RDS signal properly or if the signal is weak.

\* Not all FM stations provide RDS service, nor do they provide the same types of services. If you are not familiar with the RDS service, check with your local radio stations for details on RDS services in your area.

### Receiving RDS broadcasts

#### Simply select a station from the FM band.

When you tune in a station that provides RDS services, the station name appears in the display.

To check the RDS information

Each time you press DISPLAY on the remote, the display changes cyclically as follows:

Frequency → Station name\* → Clock

\* If the RDS broadcast is not properly received, the station name may not appear.

## Adjusting the sound

### Generating a more dynamic sound

#### — DSG

You can use the DSG (Dynamic Sound Generator) function to produce a more powerful sound.

#### Press DSG on the remote.

Each time you press the button, the display changes cyclically as follows:

DSG 1 → DSG 2 → DSG OFF

When DSG is on, “DSG” lights up.

Press DSG on the remote repeatedly to cancel DSG.

### Selecting the surround effect

#### Press SURROUND on the remote.

“SURR” appears in the display.

Press again to cancel surround effect.

### Adjusting the bass

#### Press BASS + or – on the remote repeatedly to adjust the bass.

You can adjust the bass in 7 steps (from –3 to +3).

### Adjusting the treble

#### Press TREBLE + or – on the remote repeatedly to adjust the treble.

You can adjust the treble in 7 steps (from –3 to +3).

Tips

- You can enjoy the original sound by setting BASS and TREBLE to 0.
- You cannot activate DSG and Bass/Treble adjustment at the same time.

## Falling asleep to music

### — Sleep Timer

You can set the system to turn off after a certain time, so that you can fall asleep to music.

**Press SLEEP on the remote to select a desired time.**

Each time you press the button, the minute display (the turn-off time) changes cyclically as follows:

AUTO\* → 90MIN → 80MIN → 70MIN → ... → 10MIN → OFF

\* The system automatically turns off after the current CD finishes playing (up to 100 minutes).  
When the function is TUNER, the system turns off in 100 minutes.

## Other Operations

To	Press
Check the remaining time	SLEEP on the remote once.
Change the time to turn off	SLEEP on the remote repeatedly to select the time you want.
Cancel the Sleep Timer function	SLEEP on the remote repeatedly until "OFF" appears.

### Note

When the Sleep Timer is used, you cannot use the Daily Timer.

## Waking up to music

### — Daily Timer

You can wake up to music at a preset time. Make sure you have set the clock (see "Setting the time" on page 8).

#### 1 Prepare the sound source you want to play.

- CD: Place a CD. To start from a specific track, make a program (see "Programing CD tracks" on page 11).
- Radio: Tune in a station (see "Listening to the radio" on page 13).
- Tape: Make the same setting on the timer of the component connected to the PC/TAPE jacks.

#### 2 Press VOL – or + to adjust the volume.

#### 3 Press CLOCK/TIMER SET on the remote.

#### 4 Press ◀◀ or ▶▶ repeatedly until "TIMER SET" appears, then press ENTER on the remote.

The hour indication flashes.

#### 5 Set the time to start playing.

Press ◀◀ or ▶▶ repeatedly to set the hour, then press ENTER on the remote. The minute indication flashes.

Press ◀◀ or ▶▶ repeatedly to set the minute, then press ENTER on the remote. The hour indication flashes again.

#### 6 Set the time to stop playing following the procedure in step 5.

The sound source indication flashes.

continued

**Waking up to music (continued)**

**7 Press  $\ll$  or  $\gg$  repeatedly to select the desired sound source.**

The indication changes as follows:

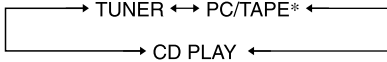

\* Select "PC/TAPE" to use an optional component connected to the PC/TAPE jacks as the sound source.

**8 Press ENTER on the remote.**

The start time, the stop time, and the sound source appear in turn, before the original display returns. "DAILY" lights up.

**9 Press I/⏻ to turn off the system.**

**Other Operations**

To	Do this
Check the setting	Press CLOCK/TIMER SELECT on the remote repeatedly until "DAILY" appears. The start time, followed by the stop time, the sound source appears, then original display appears.
Change the setting	Start over from step 1.
Cancel the timer	Press CLOCK/TIMER SELECT on the remote repeatedly until "TIMER OFF" appears.

**Notes**

- If the system is on about 30 seconds before the preset time, the Daily Timer will not be activated.
- Do not operate the system from the time the system turns on until the play starts (about 30 seconds before the preset time).
- Once you set the Daily Timer, it functions every day until you cancel it.

**Hooking up the optional components**

You can connect a digital or an analog component to this system.

To connect optional components, remove the small rear cover first.

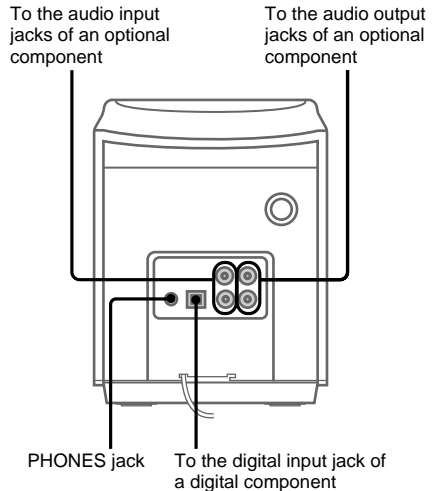

To	Do this
Make a digital recording to a digital component	Connect a optical cable.
Make an analog recording to an analog component	Connect the audio cords.
Listen to the connected optional component	Press FUNCTION repeatedly until "PC/TAPE" appears (or press PC/TAPE on the remote).
Listen through the headphones	Connect the headphones to the PHONES jack.



## Precautions

The nameplate is located on the bottom exterior.

### On safety

- The glass over the display window on the cover is made of tempered glass.  
Under normal conditions, this tempered glass is more shock resistant and able to bear more weight than ordinary glass. This glass, however, may shatter if it receives a sharp blow or if it is scratched.
- The system is not disconnected from the AC power source (mains) as long as it is connected to the wall outlet, even if the system itself has been turned off.
- Unplug the system from the wall outlet if it is not to be used for an extended period of time.  
To disconnect the power cord, pull it out by the plug. Never pull the cord itself.
- Should any solid object or liquid fall into the system, unplug the system and have it checked by qualified personnel before operating it any further.
- AC power cord must be changed only at the qualified service shop.
- When you connect the power cord to a wall outlet, even if the power is off, the system begins charging for remote and timer functions. Therefore the surface of this unit become warm, this is normal.

### On placement

- Place the system in a location with adequate air circulation, and do not place anything on top of the system.
- Do not place the system in an inclined position.
- Do not place the system in locations where it is:
  - Extremely hot or cold
  - Dusty or dirty
  - Very humid
  - Subject to vibrations
  - Subject to direct sunlight.

### On heat build up

- Although the system heats up during operation, this is not a malfunction.
- Place the system in a location with adequate ventilation to prevent heat build up in the system.

If you continuously use this system at a large volume, the cabinet temperature of the top, side and bottom rises considerably. To avoid burning yourself, do not touch the cabinet.

To prevent a malfunction, do not cover the ventilation hole for the cooling fan.

### On installing

When you move the system, remove the CD.

### On operation

If the system is brought directly from a cold to a warm location, or is placed in a very damp room, moisture may condense on the lens inside the CD player. Should this occur, the system will not operate properly. Remove the CD and leave the system turned on for about an hour until the moisture evaporates.

If you have any questions or problems concerning your system, please consult your nearest Sony dealer.

**continued**

## Precautions (continued)

### On the speaker system

This speaker system is magnetically shielded and can be used near TV sets. However, the picture on certain TV sets may become magnetically distorted. In such a case, turn off the power of the TV set once, and after 15 to 30 minutes turn it on again.

If there seems to be no improvement, locate the speaker system further away from the TV set. Also, be sure not to place objects in which magnets are attached or used near the TV set, such as audio racks, TV stands and toys. These may cause magnetic distortion to the picture due to their interaction with the system.

### Notes on CDs

- Before playing, clean the CD with a cleaning cloth. Wipe the CD from the center out.
- Do not use a CD with tape, seals, or paste on it as this may damage the player.
- Do not use solvents.
- Do not expose the CD to direct sunlight or heat sources.
- Discs with non-standard shapes (e.g., heart, square, star) cannot be played on this system. Attempting to do so may damage the system. Do not use such discs.

### Cleaning the cabinet

Use a soft cloth slightly moistened with mild detergent solution.

## Troubleshooting

If you have any problem using this system, use the following checklist.

First, check that the power cord is connected firmly and that the speakers are connected correctly and firmly.

Should any problem persist, consult your nearest Sony dealer.

### General

---

#### **There is no sound.**

- Press VOL +.
- Make sure the headphones are not connected.
- Check the speaker connections (see page 6).

#### **Sound comes from one channel, or unbalanced left and right volume.**

- Connect the speaker cords properly (see page 6).
- Place the speakers as symmetrically as possible.
- Connect only one of the supplied speakers to each set of speaker terminals.
- Connect the supplied speakers.

#### **There is severe hum or noise.**

- Move the system away from the source of noise such as TV, VCR, etc.
- Connect the system to a different wall outlet.
- Install a noise filter (commercially available) to the power line.

#### **“0:00” (for the European model) or “12:00 AM” (for other models) flashes in the display.**

- Set the clock again (see page 8).

#### **The timer cannot be set.**

- Set the clock again (see page 8).

---

**The timer does not function.**

- Press CLOCK/TIMER SELECT on the remote to set the timer and light up “DAILY” in the display (see page 16).
- Check the set contents and set the correct time (see page 16).
- Cancel the Sleep Timer function (see page 15).

---

**The remote does not function.**

- Remove the obstacle.
  - Move the remote closer to the system.
  - Point the remote at the system’s sensor.
  - Replace the battery.
  - Locate the system away from the fluorescent light.
- 

## CD Player

---

**The CD tray does not lower.**

- Place the CD vertically in the tray.
  - Always lower the tray by touching OPEN/CLOSE ▲ or pressing OPEN/CLOSE ▲ on the remote.
- 

**The CD does not eject.**

- Consult your nearest Sony dealer.
- 

**Play does not start.**

- Wipe the CD clean (see page 18).
- Replace the CD.
- Place the CD vertically in the tray.
- Place the CD in the tray with the label side front.
- Remove the CD and wipe away the moisture on the CD, then leave the system turned on for a few hours until the moisture evaporates.
- Press ►|| (or CD ► on the remote) to start play.

---

**The sound skips.**

- Wipe the CD clean (see page 18).
  - Replace the CD.
  - Try moving the system to a place without vibration (e.g., on top of a stable stand).
  - Try moving the speakers away from the system, or placing them on separate stands.
  - When you listen to a track with bass sounds at high volume, the speaker vibration may cause the sound to skip.
- 

**Play does not start from the first track.**

- Press PLAY MODE on the remote repeatedly until “PGM” and “SHUF” disappear to return to normal play.
- 

---

## Optional components

---

**There is no sound.**

- Refer to General item “There is no sound.” on page 18 and check the condition of the system.
  - Connect the component properly (see page 16) while checking:
    - if the cords are connected properly.
    - if the cord plugs are firmly inserted all the way.
  - Turn on the connected component.
  - Refer to the operating instructions included with the connected component and start playing.
- 

**The sound is distorted.**

- Set the volume of the connected component lower.
- 

continued

## Troubleshooting (continued)

### Tuner

---

#### **Severe hum or noise/stations cannot be received.**

- Set the proper band and frequency (see page 12).
  - Connect the antenna properly (see page 7).
  - Find a place and an orientation that provide good reception, then set up the antenna again. If you cannot obtain good reception, we recommend you connect a commercially available external antenna.
  - Locate the antennas as far away from the speaker cords as possible.
  - Consult your nearest Sony dealer if the supplied AM antenna has come off the plastic stand.
  - Try turning off surrounding electrical equipments.
  - Remove the FM antenna from the rear panel and place the antenna outside the cabinet. Adjust the antenna.
- 

#### **A stereo FM program cannot be received in stereo.**

- Press FM MODE until “STEREO” appears in the display.
  - See “Severe hum or noise/stations cannot be received.”, and check the antenna condition.
- 

If the system still does not operate properly after performing the above measures, reset the system as follows:

- 1** Unplug the power cord.
- 2** Hold down I/⏻, then plug the power cord into the wall outlet again.

The system is reset to the factory settings. All the settings you made such as the preset stations, clock, and timer are cleared and must be set again.

## Messages

One of the following messages may appear or flash in the display during operation.

### CD

---

#### **NO DISC**

There is no CD.

---

#### **OVER**

You have reached the end of the CD while pressing ►► during play or pause.

---

#### **STEP FULL**

You tried to program 25 or more tracks (steps).

---

# Specifications

## Main Unit (HCD-EX100)

## Amplifier section

For the U.S. model

### AUDIO POWER SPECIFICATIONS

#### POWER OUTPUT AND TOTAL HARMONIC DISTORTION:

With 4 ohms loads, both channels driven, from 120 – 10,000 Hz; rated 12 watts per channel minimum RMS power, with no more than 10% total harmonic distortion from 250 milli watts to rated output.

Canadian model:

Continuous RMS power output (Reference):  
15 + 15 watts  
(4 ohms at 1 kHz,  
10% THD)

European model:

DIN power output (Rated): 12 + 12 watts  
(4 ohms at 1 kHz, DIN)

Continuous RMS power output (Reference):  
15 + 15 watts  
(4 ohms at 1 kHz,  
10% THD)

Music power output (Reference):

15 + 15 watts  
(4 ohms at 1 kHz,  
10% THD)

Other models:

DIN power output (Rated): 12 + 12 watts  
(4 ohms at 1 kHz, DIN,  
240 V)  
12 + 12 watts  
(4 ohms at 1 kHz, DIN,  
220 V)

Continuous RMS power output (Reference):

15 + 15 watts  
(4 ohms at 1 kHz,  
10% THD, 240 V)  
15 + 15 watts  
(4 ohms at 1 kHz,  
10% THD, 220 V)

Inputs

PC/TAPE IN: voltage 250 mV,  
impedance 47 kilohms

Outputs

PC/TAPE OUT: voltage 250 mV,  
impedance 1 kilohms

CD DIGITAL OUT: Optical

PHONES (stereo mini jack):  
accepts headphones of  
8 ohms or more

## CD player section

System Compact disc and digital  
audio system  
Laser Semiconductor laser  
( $\lambda=780$  nm)  
Emission duration:  
continuous  
Frequency response 20 Hz – 20,000 Hz

## Tuner section

FM stereo, FM/AM superheterodyne tuner

### FM tuner section

Tuning range  
North American model: 87.5 – 108.0 MHz  
(100 kHz step)

Other models: 87.5 – 108.0 MHz  
(50 kHz step)

Antenna FM wire antenna  
Antenna terminals 75 ohms unbalanced  
Intermediate frequency 10.7 MHz

### AM tuner section

Tuning range  
Pan-American model: 530 – 1,710 kHz  
(with the interval set at  
10 kHz)  
531 – 1,710 kHz  
(with the interval set at  
9 kHz)

European model: 531 – 1,602 kHz  
(with the interval set at  
9 kHz)

Other models: 531 – 1,602 kHz  
(with the interval set at  
9 kHz)  
530 – 1,710 kHz  
(with the interval set at  
10 kHz)

Antenna AM loop antenna  
External antenna terminals  
Intermediate frequency 450 kHz

**continued**

## **Specifications (continued)**

### Speaker (SS-CEX100)

Speaker system	2-way, bass-reflex type
Speaker units	
Woofer:	9 cm dia., cone type
Tweeter:	5 cm dia., cone type
Impedance	4 ohms
Dimensions	130 × 220 × 183 mm (w/h/d, incl. projecting parts and controls)
Mass	Approx 2.0 kg net per speaker

### General

Power requirements	
North American model:	120 V AC, 60 Hz
European model:	230 V AC, 50/60 Hz
Other models:	110 – 240 V AC, 50/60 Hz
Power consumption	40 watts
North American model:	1.8 watts (in standby mode)
European model:	2.7 watts (in standby mode)
Dimensions	175 × 222 × 201 mm (w/h/d, incl. projecting parts and controls)
Mass	Approx. 3.2 kg
Supplied accessories	Remote commander with battery (1) AM loop antenna (1) FM wire antenna (1) Speaker cords (2)

Design and specifications are subject to change without notice.



