



感谢阁下选用Sony IC录音机！

您可使用快速入门指南获取有关IC录音机的基本操作说明。请仔细阅读本指南。希望新的Sony IC录音机能为阁下带来快乐。

使用产品前请仔细阅读本使用说明书，并请妥善保管。

检查附件。

- IC录音机 (1)
- 立体声耳机 (1)
- USB连接线 (1)
- 随机附赠夹扣式立体声麦克风 (1)
- 携带袋 (1)
- LR03 (AAA规格) 碱性电池 (2)
- 快速入门指南 (1)
- 帮助指南 (存储在内置存储器中的HTML文件, 您可方便地将其复制到您的电脑。)

选购附件

- USB交流适配器AC-UD10

■注
根据所在国家或地区, 可能不会提供一些机型或配件。

部件和控制按钮

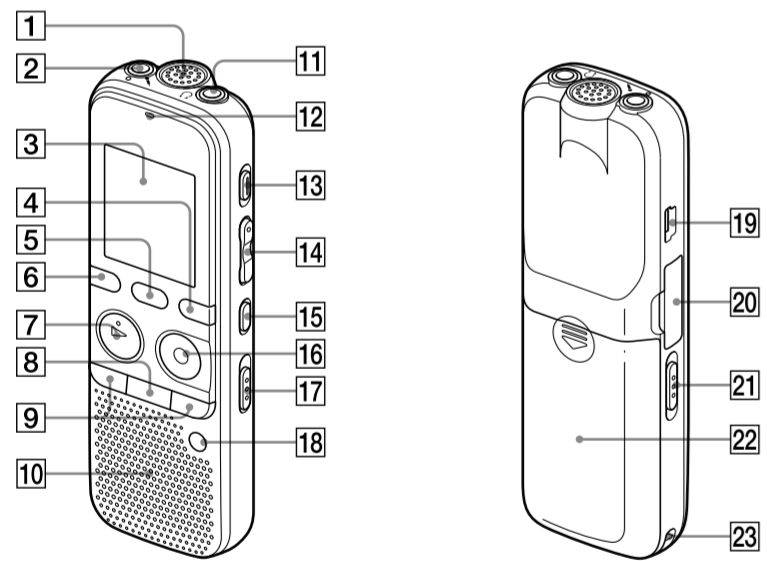

- 1 内置话筒
- 2 (话筒) 插孔*
- 3 显示屏
- 4 DISP/MENU按钮
- 5 SCENE按钮
- 6 (文件夹) 按钮
- 7 ► PLAY/STOP•ENTER*按钮
- 8 ■ (停止) 按钮
- 9 -◀◀ (回放/快退), ▶▶+ (提示/快进) 按钮
- 10 扬声器
- 11 (耳机) 插孔
- 12 操作指示灯
- 13 ERASE按钮
- 14 VOL +/- (音量-/+) 按钮*
- 15 ◀ A-B (重复A-B) 按钮
- 16 ● REC/PAUSE (录音/暂停) 按钮
- 17 NOISE CUT开关
- 18 T-MARK (曲目标记) 按钮
- 19 (USB) 接口
- 20 M2™/microSD存储卡插槽
- 21 HOLD•POWER ON/OFF开关
- 22 电池仓
- 23 腕带安装孔 (不附带腕带。)

* 这些按钮及插孔均设有触点。可将其用作操作的参考点, 或用以识别各个端口。

让我们来试用您的新IC录音机

1. 打开电源。

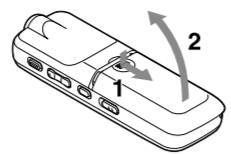

- 1 滑动并提起电池仓盖, 然后按正确极性插入电池。
- 2 打开电源。
朝“POWER ON/OFF”方向滑动并按住HOLD•POWER ON/OFF开关1秒以上。

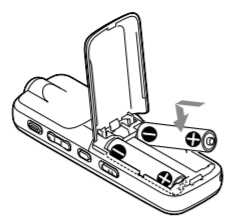

若要关闭电源, 朝“POWER ON/OFF”方向滑动并按住HOLD•POWER ON/OFF开关, 直到显示“关机”动画为止。

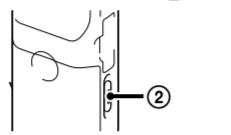

防止误操作 (HOLD)

若要释放IC录音机的HOLD状态, 请朝中心位置滑动HOLD•POWER ON/OFF开关。

2. 设置日期和时间。

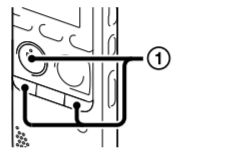

首次插入电池时或IC录音机被取出电池超过1分钟后, “请设置日期时间”出现, 之后时钟设置窗口出现。

- 1 按-◀◀或▶▶+设置年份(年份的最后两位数字), 然后按► PLAY/STOP•ENTER。重复该步骤, 依次设置月份、日期、小时和分钟。
设置分钟并按► PLAY/STOP•ENTER, 时钟会反映设置。

3. 选择菜单语言。

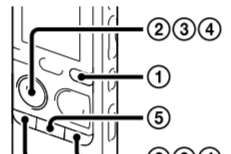

- 1 按DISP/MENU。
- 2 按-◀◀或▶▶+选择“详细菜单”, 然后按► PLAY/STOP•ENTER。
- 3 按-◀◀或▶▶+选择“语言(Language)”, 然后按► PLAY/STOP•ENTER。
- 4 按-◀◀或▶▶+选择您想要在显示窗口中使用的语言, 然后按► PLAY/STOP•ENTER。
您可以选择以下语言:
简体中文*、English (英文)
* 默认设置
- 5 按■ (停止) 返回停止模式显示。

4. 录音。

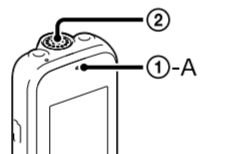

- 在开始使用IC录音机之前, 确保朝中心方向滑动HOLD•POWER ON/OFF开关以释放HOLD状态。
- 1 按● REC/PAUSE。
录音开始, 操作指示灯 (1-A) 闪烁橙色, 之后呈红色亮起。
可以按● REC/PAUSE暂停录音。再次按● REC/PAUSE可重新开始录音。
- 2 放置IC录音机时, 应将内置话筒正对所要录制的声源方向。
- 3 按■ (停止) 停止录音。
“正在访问...”动画出现, 录音停止。

5. 聆听。

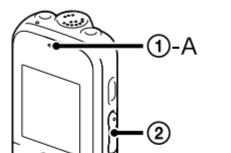

- 1 按► PLAY/STOP•ENTER。
播放开始, 操作指示灯 (1-A) 呈绿色亮起。
- 2 按VOL +/-调整音量。
- 3 按■ (停止) 停止播放。

6. 删除。

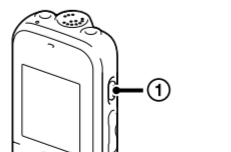

- 文件一旦删除, 则将无法恢复。
- 1 按ERASE。
“确定删除?”显示, 播放要删除的文件供您确认。
- 2 使用-◀◀或▶▶+选择“是”, 然后按► PLAY/STOP•ENTER。
“正在删除...”动画出现, 所选文件被删除。

与电脑组合使用

在您的电脑上安装帮助指南

通过从IC录音机的内置存储器安装帮助指南到您的电脑, 在发生问题时您可搜索详细的操作和可能的解决方法。

- 1 用附带的USB连接电缆, 将IC录音机的(USB)接口与正在运行中的电脑的USB端口连接起来, 连接电缆应牢固插入接口, 直至各端插头到达底端为止。
- 2 在Windows中: 单击 [计算机] (或 [我的电脑]), 然后双击 [IC RECORDER] → [FOR WINDOWS]。
在Mac中: 双击桌面上的 [IC RECORDER]。
- 3 安装帮助指南。
在Windows中: 双击 [Help_Guide_Installer] (或 [Help_Guide_Installer.exe])。
在Mac中: 双击 [Help_Guide_Installer_for_mac.app]。(v10.5.8或更高版本) 按照屏幕上出现的指示继续安装。
- 4 安装完成之后, 双击桌面 (Windows) 上 (或查找程序 (Mac) 中) 的 [Help_Guide_icdp33_cn.htm] 图标。
将显示帮助指南。
您也可在以下Sony IC录音机用户支持主页的中查阅帮助指南:
<http://rd1.sony.net/help/icd/p33/cn/>

将文件从IC录音机复制到电脑

可以将IC录音机的文件和文件夹复制到电脑上进行保存。

- 1 将IC录音机连接到电脑上。
- 2 将要传输的文件或文件夹复制到电脑上。
将要复制的文件或文件夹从“IC RECORDER”或“MEMORY CARD”拖放到电脑的本地磁盘上。

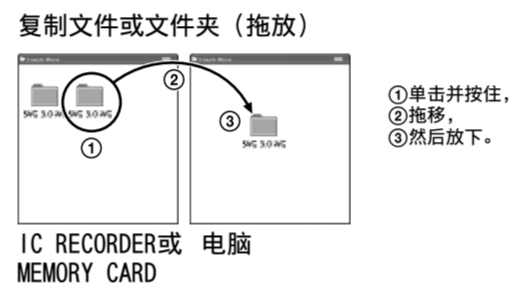

- 3 将IC录音机从电脑上断开。

安装Sound Organizer

在您的电脑上安装Sound Organizer。

■注
Sound Organizer只兼容Windows PC。不兼容Mac。

安装Sound Organizer时, 以管理员权限登录。

- 1 请从您电脑上访问以下Sony Service网站:
<http://service.sony.com.cn>
- 2 在以上网站的搜索框中输入“Sound Organizer”, 就能够找到Sound Organizer的下载页面。
- 3 按照下载页面的步骤下载并安装Sound Organizer。

其他功能

有关录音、播放和编辑等其它功能的详情包括在帮助指南中。

- 场景选择
- 消除噪音
- T-MARK (曲目标记)
- DPC (Digital Pitch Control)
- A-B重复
- VOR (Voice Operated Recording)
- 闹铃
- 简易搜索
- 分割 (Divide)
- Sound Organizer编辑软件

注意事项

电源
IC录音机须使用3.0 V或2.4 V电源。使用两节LR03 (AAA规格) 碱性电池或NH-AAA充电电池。

安全
驾车、骑车或操作任何机动车时请勿操作IC录音机。

操作管理
• 请勿将IC录音机靠近热源或放置于阳光直射、灰尘很多或有机机械振动的地方。

• 若有任何固体或液体落入IC录音机, 在进一步操作前, 请取出电池并请有资格的人员进行检查。

如果对IC录音机有任何疑问或问题, 请向最近的Sony经销商咨询。

制造商: 索尼 (中国) 有限公司
地 址: 北京市朝阳区
太阳宫中路12号楼
冠城大厦701
产 地: 广东省东莞市
产品标准: Q/CYSNC0007
出版日期: 2013年1月

警告
请勿将电池 (已安装的电池组或电池) 长时间暴露于例如阳光, 火等极热的地方。

USB AC适配器: AC-UD10

额定电流: 1500 mA

注意
如果使用不正确的电池类型更换电池有爆炸的危险。请按照规定处理使用过的电池。

容量 (可用容量*)
4 GB (约3.60 GB = 3,865,470,566字节)
*少量内置存储被用于文件管理, 因而不可用于用户存储。

产品中有毒有害物质或元素的名称及含量



(○:不含有, ×:含有)

部件名称	有毒有害物质或元素					
	铅 (Pb)	汞 (Hg)	镉 (Cd)	六价铬 (Cr (VI))	多溴联苯 (PBB)	多溴二苯醚 (PBDE)
内置线路板	×	○	○	○	○	○
外壳	×	○	○	○	○	○
显示板	○	○	○	○	○	○
扬声器	×	○	○	○	○	○
附件	○	○	○	○	○	○

○: 表示该有毒有害物质在该部件所有均质材料中的含量均在SJ/T11363-2006标准规定的限量要求以下。

×: 表示该有毒有害物质至少在该部件的某一均质材料中的含量超出SJ/T11363-2006标准规定的限量要求。



Let's try out your new IC recorder

1. Power on.

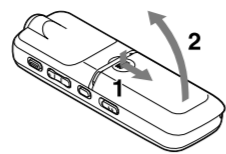

- Slide and lift the battery compartment lid, then insert batteries with the correct polarity.
- Turn the power on. Slide and hold the HOLD•POWER ON/OFF switch in the direction of "POWER ON/OFF" for more than 1 second.



To turn the power off, slide and hold the HOLD•POWER ON/OFF switch in the direction of "POWER ON/OFF" until "关机" is displayed.

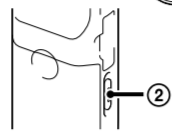

To prevent unintentional operations (HOLD)



To release the IC recorder from the HOLD status, slide the HOLD•POWER ON/OFF switch towards the center.

2. Set the date and time.

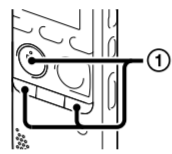

When you insert a battery for the first time, or after the IC recorder has been without a battery for more than 1 minute, "请设置日期时间" appears, and then the clock setting window appears.

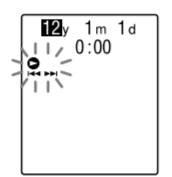

- Press **←** or **→** to set the year (the last two digits of the year), and then press **▶** PLAY/STOP•ENTER. Repeat this procedure to set month, day, hour, and minute in sequence. When you set the minute and press **▶** PLAY/STOP•ENTER, the clock reflects the setting.

3. Select the menu language.

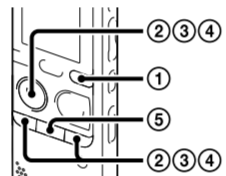

- Press DISP/MENU.
- Press **←** or **→** to select "详细菜单", and then press **▶** PLAY/STOP•ENTER.
- Press **←** or **→** to select "语言 (Language)", and then press **▶** PLAY/STOP•ENTER.
- Press **←** or **→** to select the language that you want to use in the display window, and then press **▶** PLAY/STOP•ENTER. You can select the following languages:
简体中文* (Chinese), English
* Default setting
- Press **■** (stop) to return to the stop mode display.



4. Record.

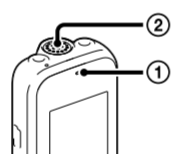

Before you start using the IC recorder, make sure that you slide the HOLD•POWER ON/OFF switch towards the center to release the HOLD status.

- Press **●** REC/PAUSE. Recording starts and the operation indicator (①-A) flashes in orange, and then lights in red.
You can pause recording by pressing **●** REC/PAUSE. Press **●** REC/PAUSE again to restart recording.



- Place the IC recorder so that the built-in microphone face the direction of the source to be recorded.
- Press **■** (stop) to stop recording. The "正在访问..." animation appears and the recording stops.

5. Listen.

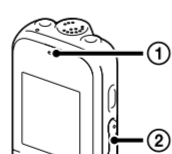

- Press **▶** PLAY/STOP•ENTER. Playback starts and the operation indicator (①-A) lights in green.
- Adjust the volume by pressing VOL **-/+**.
- Press **■** (stop) to stop playback.

6. Erase.

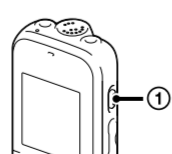

- Once a file is erased, you cannot restore it.
- Press ERASE. "确定删除?" is displayed and the file to be erased is played back for confirmation.
 - Select "是" using **←** or **→**, and then press **▶** PLAY/STOP•ENTER. The "正在删除..." animation appears and the selected file is erased.

Utilizing Your Computer

Installing the help guide on your computer

By installing the help guide on your computer from the built-in memory of the IC recorder, you can search for detailed operations and possible solutions when a problem occurs.

- Connect the **⇄** (USB) connector of the IC recorder with the USB port of your running computer with the supplied USB connecting cable inserted into the connectors securely until each plug stops to the end.
- In Windows: Click [Computer] (or [My Computer]), then double-click [IC RECORDER] → [FOR WINDOWS].
In Mac: Double-click [IC RECORDER] on the desktop.
- Install the help guide.
In Windows: Double-click [Help_Guide_Installer] (or [Help_Guide_Installer.exe]).
In Mac: Double-click [Help_Guide_Installer_for_mac.app] (v10.5.8 or higher) Follow the instructions that appear on the screen to proceed with installation.
- After the installation completes, double-click the [Help_Guide_icdp33_cn.htm] icon in the desktop for Windows (or in Finder for Mac). The help guide is displayed. You can also view the help guide on the following Sony IC Recorder customer support home page:
<http://rd1.sony.net/help/icd/p33/cn/>

Copying files from the IC recorder to your computer

You can copy the files and folders from the IC recorder to your computer to store them.

- Connect the IC recorder to your computer.
- Copy files or folders you want to transfer to your computer. Drag and drop the files or folders you want to copy from "IC RECORDER" or "MEMORY CARD" to the local disk on your computer.

To copy a file or folder (Drag and drop)

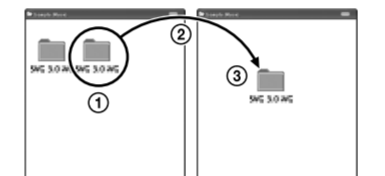

- Click and hold,
- drag,
- and then drop.

- Disconnect the IC recorder from your computer.

Installing Sound Organizer

Install Sound Organizer on your computer.

Note
Sound Organizer is compatible with the Windows PC only. It is not compatible with Mac.

When installing Sound Organizer, log in to an account with administrator privileges.

- Access the following Sony Service web site from your computer:
<http://service.sony.com.cn>
- On the above web site, enter "Sound Organizer" in the search box to locate the Sound Organizer download page.
- Follow the procedures instructed on the download page to download and then install the Sound Organizer.

Welcome to your new Sony IC recorder!

This is the Quick Start Guide, which provides you with instructions on the basic operations of the IC recorder. Please read it carefully. We hope you enjoy using your new Sony IC recorder.

Check the supplied items.

- IC Recorder (1)
- Stereo headphones (1)
- USB connecting cable (1)
- Stereo Microphone with Shirt-Clip (1)
- Carrying pouch (1)
- LR03 (size AAA) alkaline batteries (2)
- Quick Start Guide (1)
- Help Guide (HTML file stored in the built-in memory so it can easily be copied to your computer.)

Optional accessories

- USB AC adaptor AC-UD10

Note
Depending on the country or region, some of the models or optional accessories are not available.

Parts and controls

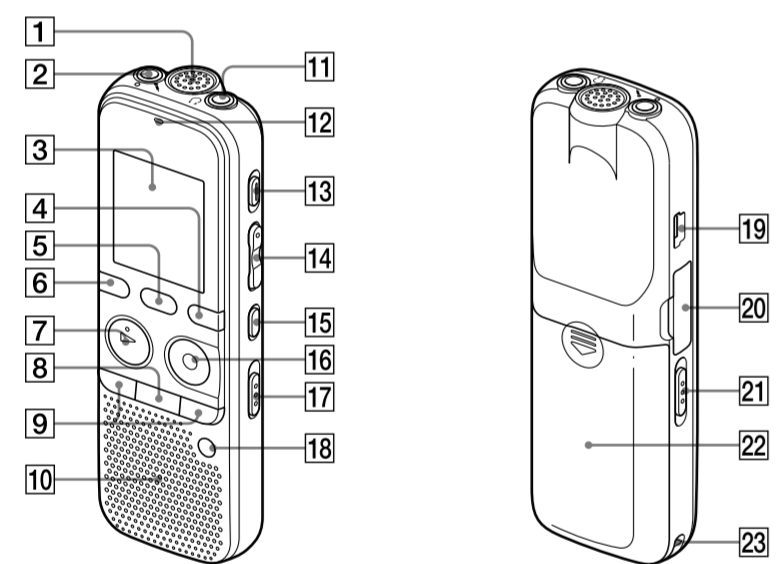

- Built-in microphone
- (microphone) jack*
- Display window
- DISP/MENU button
- SCENE button
- (folder) button
- ▶ PLAY/STOP•ENTER* button
- (stop) button
- ← (review/fast backward), → (cue/fast forward) buttons
- Speaker
- (headphones) jack
- Operation indicator
- ERASE button
- VOL **-/+** (volume **-/+**) button*
- ⇄ A-B (repeat A-B) button
- REC/PAUSE (record/pause) button
- NOISE CUT switch
- T-MARK (track mark) button
- ⇄ (USB) connector
- M2™/microSD memory card slot
- HOLD•POWER ON/OFF switch
- Battery compartment
- Strap hole (A strap is not supplied.)

* These buttons and the jack have a tactile dot. Use it as a reference point for operations, or to identify each terminal.

Additional features

Details of these additional features for recording, playback, and editing are included in the help guide.

- Scene Selection
- 消除噪音 (Noise Cut)
- T-MARK (Track mark)
- DPC (Digital Pitch Control)
- A-B Repeat
- VOR (Voice Operated Recording)
- 闹铃 (Alarm)
- 简易搜索 (Easy Search)
- Divide
- Sound Organizer editing software

Precautions

On power
Operate the IC recorder on 3.0 V or 2.4 V. Use two LR03 (size AAA) alkaline batteries or NH-AAA rechargeable batteries.

On safety
Do not operate the IC recorder while driving, cycling or operating any motorized vehicle.

On handling
Do not leave the IC recorder in a location near heat sources, or in a place subject to direct sunlight, excessive dust or mechanical shock.

Should any solid object or liquid fall into the IC recorder, remove the battery and have the IC recorder checked by qualified personnel before operating it any further.

If you have any questions or problems concerning your IC recorder, please consult your nearest Sony dealer.

WARNING

Do not expose the batteries (battery pack or batteries installed) to excessive heat such as sunshine, fire or the like for a long time.

CAUTION

Risk of explosion if battery is replaced by an incorrect type. Dispose of used batteries according to the instructions.

Capacity (User available capacity*)

4 GB (approx. 3.60 GB = 3,865,470,566 Byte)

* A small amount of the built-in memory is used for file management and therefore not available for user storage.

For the customers in China
RATED CURRENT CONSUMPTION: 1500 mA

AC adaptor: AC-UD10