

Head Mounted Display

Reference Guide

Before Initial Use

Refer to the “Startup Guide” for instructions on connecting the system, wearing the unit, and completing initial settings.

Warning

To reduce the risk of fire or electric shock, do not expose this apparatus to rain or moisture.

To reduce the risk of fire, do not cover the ventilation opening of the appliance with newspapers, tablecloths, curtains, etc.

Do not expose the appliance to naked flame sources (for example, lighted candles).

To reduce the risk of fire or electric shock, do not expose this appliance to dripping or splashing, and do not place objects filled with liquids, such as vases, on the appliance.

As the power plug (main plug) is used to disconnect the unit from the wall outlet (mains), connect the unit to an easily accessible AC outlet.

Should you notice an abnormality in the unit, disconnect the power plug (main plug) from the AC outlet (mains) immediately.

Do not install this equipment in a confined space such as a bookshelf or similar unit.

Do not expose batteries or appliances with battery installed to excessive heat, such as sunshine and fire.

Precautions

The set is not disconnected from the AC power source (mains) as long as it is connected to the wall outlet (mains), even if the set itself has been turned off.

The nameplate is located on the bottom of the processor unit, and on the bottom of the battery unit.



Sony Corporation

1-7-1, Konan, Minato-ku, Tokyo, Japan, 108-0075

Made in Japan

Importer on the territory of the CU: CJSC "Sony Electronics", 123103, Moscow, Karamyshevsky lane 6, Russia.

The production Date is indicated on the bottom of the processor unit.

This equipment has been tested and found to comply with the limits set out in the EMC Directive using a connection cable shorter than 3 meters.

Product name: Head Mounted Display

The Sony HMZ-T3 is a head mounted display for watching 2D/3D movies and play 2D/3D games from connected Blu-ray Disc™ player and game consoles.

Warning

To reduce the risk of fire or electric shock, do not expose this apparatus to rain or moisture.

To reduce the risk of fire, do not cover the ventilation opening of the appliance with newspapers, tablecloths, curtains, etc.

Do not expose the appliance to naked flame sources (for example, lighted candles).

To reduce the risk of fire or electric shock, do not expose this appliance to dripping or splashing, and do not place objects filled with liquids, such as vases, on the appliance.

As the power plug (main plug) is used to disconnect the unit from the wall outlet (mains), connect the unit to an easily accessible AC outlet.

Should you notice an abnormality in the unit, disconnect the power plug (main plug) from the AC outlet (mains) immediately.

Do not install this equipment in a confined space such as a bookshelf or similar unit.

Do not expose batteries or appliances with battery installed to excessive heat, such as sunshine and fire.

Precautions

The set is not disconnected from the AC power source (mains) as long as it is connected to the wall outlet (mains), even if the set itself has been turned off.

The nameplate is located on the bottom of the processor unit, and on the bottom of the battery unit.



Виробник:

Sony Corporation 1-7-1, Konan, Minato-ku, Tokyo, Japan, 108-0075.

Країна-виробник: Японія

Уповноважений представник в Україні:

ТОВ «Соні Україна», вул. Спаська 30, м.Київ, 04070, Україна.

Обладнання відповідає вимогам:

– Технічного регламенту безпеки

низьковольтного електричного

обладнання (постанова КМУ від 29.10.2009 № 1149);

– Технічного регламенту з електромагнітної сумісності обладнання (постанова КМУ від 29.07.2009 № 785);

– Технічного регламенту обмеження використання деяких небезпечних речовин в електричному та електронному обладнанні (постанова КМУ від 03.12.2008 № 1057).

This equipment has been tested and found to comply with the limits set out in the EMC Directive using a connection cable shorter than 3 meters.

Product name: Head Mounted Display

Health Precautions

Age Limitations

Watching video images or playing games by this device may affect the health of growing children. This device should not be used by children 15 and under.

Use password protection feature (page 30) of this device to restrict children from using this device.

Watching Video with the Head Mounted Display

- Some people may experience discomfort (such as eye strain, fatigue, nausea, or motion sickness) while watching video images or playing games. Sony recommends that all viewers take regular breaks while watching video images or playing games. The length and frequency of necessary breaks will vary from person to person. You must decide what works best. If you experience any discomfort, you should stop watching the video images or playing games until the discomfort ends; consult a doctor if you believe necessary.
- Avoid wearing the unit in environments where your head may shake, or while you are walking or performing exercise, because there is a higher possibility that you experience discomfort.
- You should also review (i) the instruction manual of any other device or media used with this device and (ii) our website below for the latest information.

For customers in Europe, Russia, Ukraine and UK:

<http://www.sony-europe.com/support>

For customers in the U.S.A. and Latin America:

<http://esupport.sony.com/>

For customers in Canada:

<http://esupport.sony.com/CA/>

For customers in China:

<http://service.sony.com.cn/index.htm>

For customers in other countries/regions:

<http://www.sony-asia.com/support/>

Correct Use

- Ensure that you are wearing the head mounted unit correctly.
 - For instructions on wearing the unit, refer to the “Startup Guide.”
 - To avoid watching with the screens skewed, check screen alignment by referring to the confirmation screen displayed initially.
 - Note that dropping the unit or handling it roughly may skew the screens.
- Do not touch the processor unit, the battery unit or the AC adaptor for a long time when it is in use. Continuous contact of skin with the unit may cause low temperature burn.
- The head mounted unit can be adjusted in a range of 53.0 mm – 76.7 mm (2 1/8 in. – 3 1/8 in.) to suit the distance between your eyes (interpupillary distance). If you cannot use the system within this range, refrain from using the system.
- By default, a warning message for automatic shutdown will be displayed after three hours of continuous viewing. If you clear the message and continue watching, the system will automatically turn off after another 3 hours.

For Comfortable Viewing

Images are perceived as appearing some distance from the viewer.

If you normally wear glasses or contact lenses, wear them as usual during use (with the exception of reading glasses). Note that watching with bifocals may be less than optimal.

Precautions

Power Supply

Position the AC adaptor near the wall outlet (mains) used. In case of strange noises, fumes, or smoke from the system, immediately unplug the AC power cord (mains lead) to turn all power off. Only pressing the power button on the head mounted unit or the processor unit will not turn the system off completely.

AC Adaptor

- Do not use any unspecified adaptor. It may cause failure of the product.
- Performance and safety are not guaranteed if any other USB cable or AC power cord (mains lead) than those exclusive to this system is used.
- Do not disassemble or modify the AC adaptor.
- Do not touch metal parts of the AC adaptor. Especially keep in mind that touching it with a metal tool may cause a short-circuit, damaging the AC adaptor.
- Operations are not guaranteed if any USB hub or USB extension cable is used. Be sure to use the exclusive USB cable supplied with the system and follow the connecting instructions specified by the device to be connected.

Built-in Battery

- It is recommended to replace the battery if the operation time with the battery fully charged becomes almost half that with initial use. Consult your nearest Sony service center.
- The completely discharged battery can be recharged normally 500 times. The number of times varies depending on the conditions of use.
- If the product will not be used for an extended period, recharge the battery every six months to eliminate battery degradation.

Installation Environment

Avoid installation in the following environments.

- Places subject to vibration
- In direct sunlight, or where it is very hot or humid
- Places that are extremely cold

Also avoid putting liquid-filled containers (such as flower vases) on top of the processor unit or the battery unit, or using the system where it may be splashed. The system may be damaged if splashed with water.

Transport

Do not move the product pulling it by the cable or the headband. The product may fall or crash, causing damage to the product.

Condensation

Condensation occurs when moisture in the air condenses on metal panels or other parts, forming droplets. Condensation may form on outer surfaces or internally if the system is suddenly moved from a cold to a warm environment, or when a heater is turned on in a cold room where the system is installed. If condensation forms, do not use the system until the droplets evaporate.

- If the system is not plugged into a wall outlet (mains)
Leave the system unplugged, and wait until the droplets evaporate.
- If the system is not on
Leave the system off, and wait until the droplets evaporate.
- If the system is on
Leave the system on, and wait until the droplets evaporate.

Using the system when condensation has formed may damage it.

Static Electricity

You may feel a tingling sensation in your ears in dry seasons. It does not indicate that the system is damaged, but is due to static electricity accumulated in your body. The influence of static electricity may be reduced by wearing clothes made of

natural materials that generate less static electricity.

Lens Care

- Handle the lenses on the head mounted unit carefully to avoid smears or scratches. If the lenses become dirty, wipe them gently with a soft lens-cleaning cloth.
- Do not use liquid solutions, such as lens-cleaning fluid, water, or alcohol-based cleaners.
- Do not impart excessive shock or force to the lenses. A chipped or cracked lens could cause injury. If the lens is chipped or cracked, stop using the system immediately and do not touch the damaged part.

Cleaning the System

Clean outer surfaces of the system using a soft cloth lightly moistened with a mild detergent. Do not use solvents, such as thinner, benzene, or alcohol, which may damage surfaces.

Headphone Care

- A dirty headphone plug may cause static or skipping. To ensure optimal sound, clean the plug with a soft cloth occasionally.
- Also clean the earbuds. Remove the earbuds from the headphones and hand-wash them using a mild detergent. After washing, dry the earbuds thoroughly before use.

Extended Listening at High Volume

Listening at high volume over extended periods may harm hearing. To protect your hearing, avoid listening at excessive volume.

Initial Volume

To avoid sudden loud output, keep the initial volume low. Increase the volume gradually until the desired level is reached.

Packaging Materials

Keep the original box and protective cushioning for future use, in case you move or need to ship the system for repair or other reasons.

HDMI Jacks and Connectors

Take these precautions to avoid damaging HDMI jacks and connectors.

- When inserting cables, note the shape and orientation of the connector and the HDMI jack on the battery unit or the processor unit.

HDMI input and output

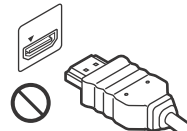

The connector is upside-down

HDMI input and output

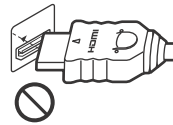

The connector is not straight

- Before moving the processor unit, always disconnect the HDMI cable.



- When connecting or disconnecting HDMI cables, hold the connector straight. Do not hold the connector at an angle or force it into the HDMI jack.
- Use either the supplied HDMI cable or a commercially available High-Speed HDMI cable.

Headphone Handling

- If you experience an allergic reaction to the supplied headphones, stop using them at once and contact a doctor.
- When you unplug the headphones from the head mounted unit or the processor unit, make sure to hold the headphone

plug to unplug it. Pulling by the
headphone cord itself may damage it.

- Earbuds may deteriorate after extended
use or storage.

Contents

Health Precautions	4
Precautions	5
Supplied Accessories	9
Parts and Controls	10
Charging the Battery	13
Using with a Portable Device	14
Fitting the Head Mounted Unit	15
Confirming Screen Alignment	20
System Settings	22
Troubleshooting	33
Specifications	41
Trademarks	44

Supplied Accessories

Make sure the following items are included with the system after purchase. If any items are missing, contact your Sony dealer or a local authorized Sony service center.

For installation of the supplied accessories, refer to the "Startup Guide."

- AC power cord (mains lead) (2)
Use the supplied AC power cord (mains lead) only with this system, not with other electronics.
- AC adaptor (large) (AC-L200D) (1)

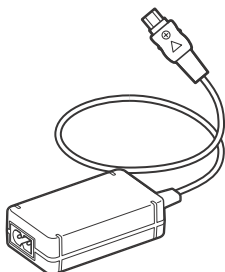

- AC adaptor (small) (AC-UD10) (1)

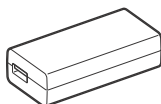

- Micro USB cable (for AC-UD10) (1)

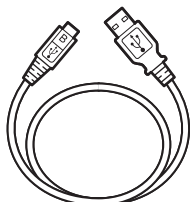

- HDMI cable (1.5 m (1), 3 m (1))

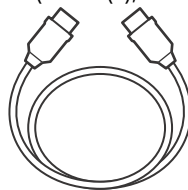

- Light blocker (Bottom) (1)

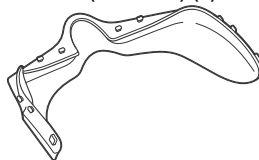

- Connecting cord holder (1)



- Headphones (1)

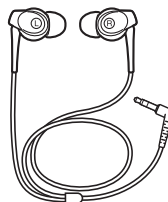

- Earbuds (1 set)
Medium-sized earbuds are initially attached, at the time of purchase.
- Carrying case (1)

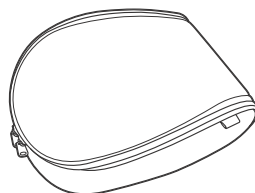

- Reference Guide (this guide)
- Startup Guide

Parts and Controls

For connection and wearing of the system, refer to the "Startup Guide."

Head Mounted Unit

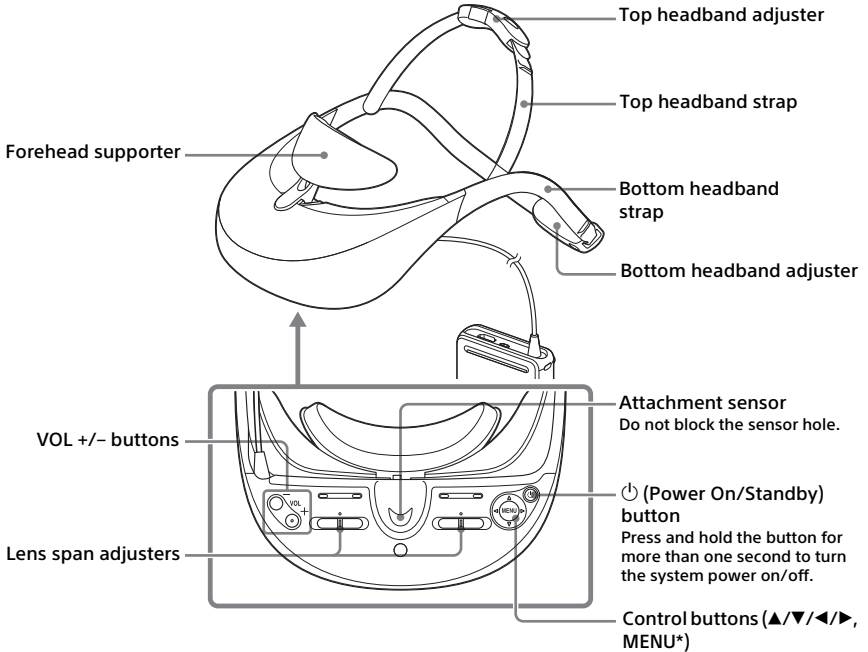

* The MENU button serves two purposes. Press the MENU button to view setting menus as well as to confirm setting changes (when it functions as an Enter button).

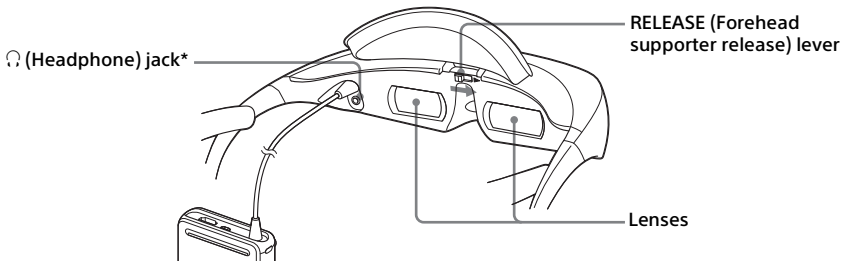

* Either the supplied headphones or your own stereo mini-plug headphones can be connected.

Note

- The cord connecting the head mounted unit and the battery unit cannot be disconnected.

Battery Unit (Front)

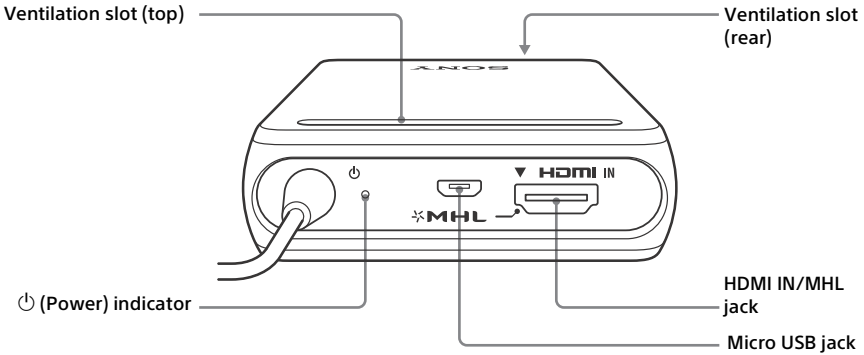

Processor Unit (Front/Top)

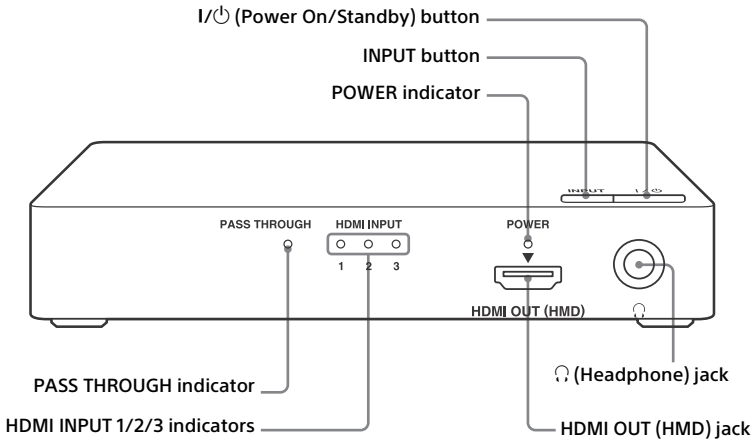

Processor Unit (Rear)

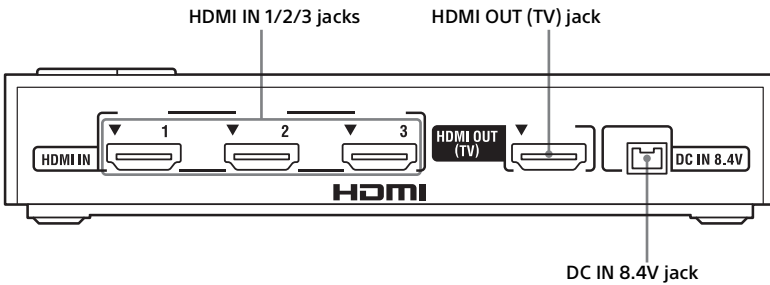

Indicators

The indicators on the battery unit and processor unit show the statuses of this system.

	Indication	Status
Battery Unit		
⏻ (Power) indicator	Lit in green	Power On (not charging)
	Lit in orange	Power On or Off (during charging)
	Unlit	Power Off (not charging)
Processor Unit		
POWER (Power) indicator	Lit in green	Power On
	Lit in red	Standby with Power Off
	Unlit	Power unconnected
PASS THROUGH indicator	Lit in orange	Power Off (Standby) with "HDMI pass-through" set at "On"
	Unlit	In cases other than the mentioned above
HDMI INPUT 1/2/3 indicators	Lit in orange	The indicator for the selected HDMI input lights.
	Unlit	Standby with "HDMI pass-through" set at "Off"

For alerts by the indicators, see "Warning by the indicator" in "Troubleshooting" (page 40).

Charging the Battery

When the system is to be used for the first time or the battery is exhausted, recharge the battery. For details on charging, refer to the "Startup Guide."

Connect the AC-UD10 AC adaptor (small) and the AC power cord to the battery unit to start charging. The ⏻ (power) indicator is lit in orange during charging, and the indicator goes dark when charging is completed (if the system power was off).

Tip

- Charging is possible even while the system is turned on, but longer charging time is required. We recommend charging with the system turned off when the system is not to be used.

Notes

- Charging may not be possible or longer charging time may be required depending on ambient temperature or other conditions of use. Perform charging under temperatures from 5 °C to 35 °C (41 °F to 95 °F).
- The battery unit and the AC adaptor become warm when the system is in use or while charging. This is not a problem for safety. If the battery unit or the AC adaptor is excessively hot, stop using the system and turn off the system power.

Charging time and operating time

The charging time and the operating time are as follows at room temperature of 23 °C (74 °F).

Charging time	Approx. 5.5 hours (in operation)
	Approx. 4.5 hours (in standby mode)
Operating time	Approx. 7 hours (in operation)
	Approx. 3 hours (in MHL operation)

Notes

- The charging time and operating time may differ, depending on ambient temperature, the battery condition and other conditions of use.
- Longer charging time is required or charging is not completed in the following cases:
 - when equipment is connected to the battery unit and operated in MHL connection
 - under high ambient temperatures

Checking the remaining battery capacity

Press the MENU button on the head mounted unit to display the menu then select "Information."

The remaining battery capacity appears on the top right of the Information screen (page 23).

Remaining battery indicator

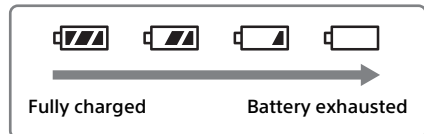

Using with a Portable Device

The system can be used by connecting the battery unit directly to playback equipment using an HDMI cable. With this connection, you can use the system where there is no AC power supply.

An MHL device can be connected using the MHL cable (sold separately).

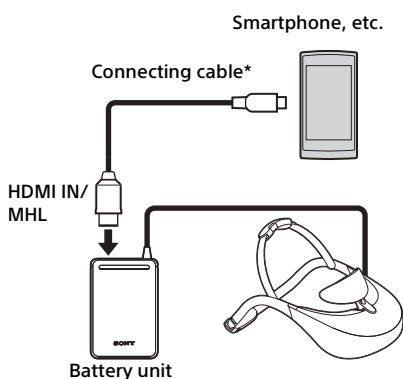

* For connecting an MHL device, use the MHL cable (sold separately), or for connecting other playback equipment, use the HDMI cable.

Note

- With this connection method excluding the processor unit, some setting items in the Sound menu (page 28) and the General Setup menu (page 30) are not available and you cannot use those functions.

Using the Carrying Case

You can pack the system in the supplied carrying case. Put the battery unit in the pocket and fix the head mounted unit with the hook and loop fastener.

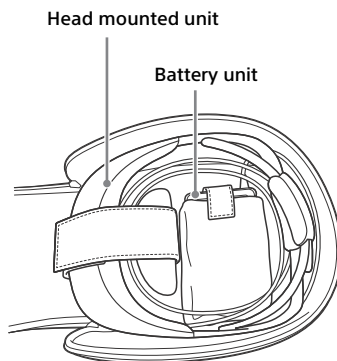

Fitting the Head Mounted Unit

The head mounted unit can be adjusted in several ways to ensure a personalized, comfortable fit. For a more comfortable fit, always adjust the head mounted unit before putting it on.

When fitting the head mounted unit for the first time after purchase, refer to the "Startup Guide."

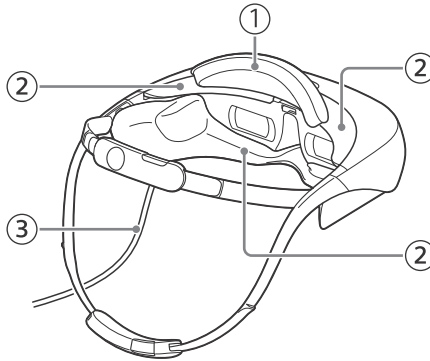

① Adjusting the forehead supporter

The forehead supporter can be adjusted back and forth or up and down.

To adjust back and forth

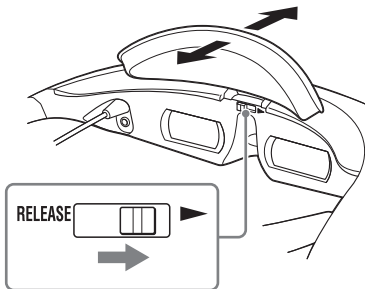

To move the forehead supporter back and forth, slide the RELEASE (forehead supporter release) lever toward the right, then move the forehead supporter.

To adjust up and down

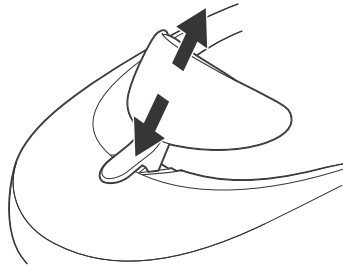

Move the forehead supporter up and down.

Tip

- Adjust the position of the forehead supporter forward or downward if the head mounted unit contacts your glasses or nose.

② Light blocker

The top light blockers are detachable. If external light reflected on the screens is distracting, attach the light blockers.

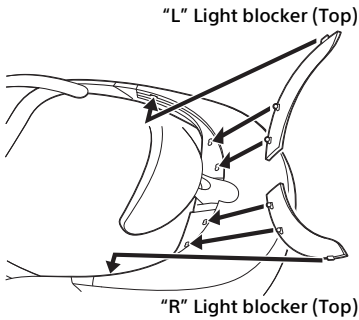

The upper-left light blocker is labeled "L," and the upper-right one, "R." Attach the correct top light blocker on each side by pushing the tabs into the three holes on the top of the lens section.

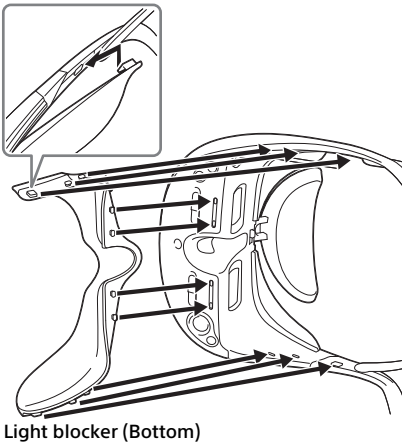

To attach the bottom light blocker, push the tabs into the 8 holes on the bottom and side of the lens, and hook on the right and left ends.

Notes

- It may not be possible to attach the light blockers when wearing some sorts of glasses.
- If external light is still distracting with the light blockers on, dim the room lights or move away from external light.

③ Attaching the connecting cord holder

To keep the connecting cords of the head mounted unit out of the way, use the supplied connecting cord holder and attach the connecting cord to the bottom headband.

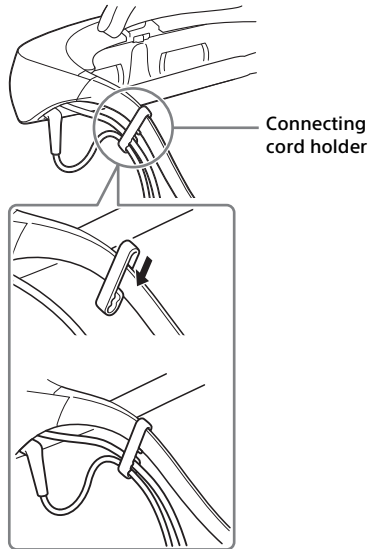

For a Comfortable Fit

Have the weight of the head mounted unit balanced between your forehead and the back of your head

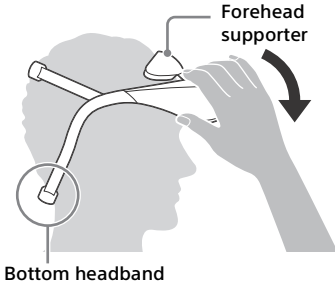

Wear the head mounted unit so that it feels balanced between the forehead supporter and bottom headband, and after repositioning it to bring the lenses in front of your eyes, make sure it fits securely.

Be sure to leave a space between the bridge of the head mounted unit (between the lenses) and your face, so that the unit does not touch your nose.

Ensure a secure fit

If either headband is too loose or too tight, adjust the strap length for a better fit.

To adjust the straps on the right

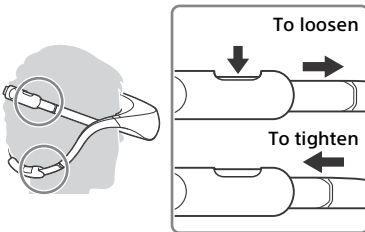

To loosen, hold down the fastener button on the headband adjuster as

you pull the right end of the strap out a little.

To tighten, simply push the right end of the strap in a little.

To adjust the straps on the left

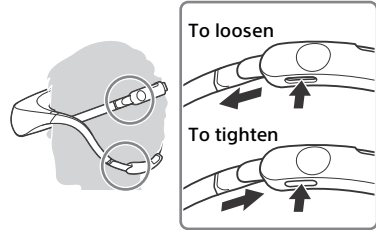

To loosen, hold down the fastener button on the bottom of the headband adjuster as you pull the left end of the strap out a little.

To tighten, hold down the fastener button on the bottom of the headband adjuster and push the left end of the strap in a little.

Note

- The circles on the headband adjusters are the caps for the accessory fixing screw holes for future use. They are not buttons and are inoperative when pressed.

Attaching and Replacing Earbuds

Bass may be inaudible unless earbuds fit well. For a better listening experience, try a different earbud size or adjust the position of the earbuds, so that they fit perfectly in your ears. Medium-sized earbuds are initially attached to the headphones, at the time of purchase. If the earbuds feel uncomfortable, try replacing them with the supplied large or small earbuds. Earbud sizes are color-coded and can be identified by the color inside.

To avoid having the earbuds come off in your ear, be sure to attach earbuds securely to the headphones when replacing them.

Earbud sizes (inside color)

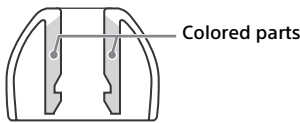

Small ↔ Large

S (Orange)	M (Green)	L (Light blue)
---------------	--------------	-------------------

To detach an earbud

While holding the headphone securely, twist the earbud as you pull it off.

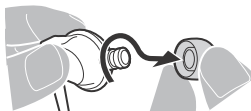

Tip

- If the earbud slips in your fingers and remains attached, try holding it with a dry cloth for a better grip.

To attach an earbud

Push the parts inside of the earbud into the headphone until the projecting part of the headphone is fully covered.

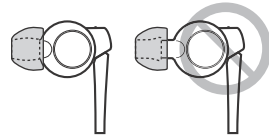

Replacing Consumables

The following replacement parts are available.

- Earbuds*
- Light blocker (Top) (1 each for the left and right)
- Light blocker (Bottom)
- Connecting cord holder
- Forehead supporter cushion
- Headband adjuster cushion

When these consumables break or show signs of wear, consult your nearest Sony dealer or Sony service center.

* Optional replacement earbuds can be ordered from your nearest Sony dealer.

Replacing the forehead supporter cushion or headband adjuster cushion

The cushion is attached with double-back tape. To replace the cushion, peel off the old cushion from the forehead supporter or the headband adjuster then put a new cushion in the same place.

Forehead supporter cushion

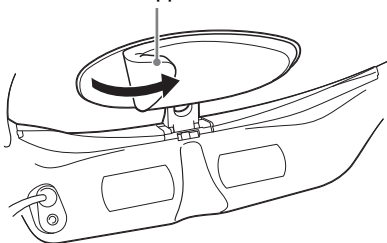

Headband adjuster cushion

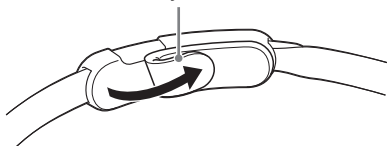

Confirming Screen Alignment

Confirm screen alignment by referring to the confirmation screen displayed initially after lens span adjustment. Screens on the head mounted unit are described below, with an explanation of how to confirm alignment.

The display section of the head mounted unit consists of two small screens, on the left and right. Images on each screen overlap to form a single image. Always check screen alignment by referring to the confirmation screen before use to make sure the screens are aligned properly.

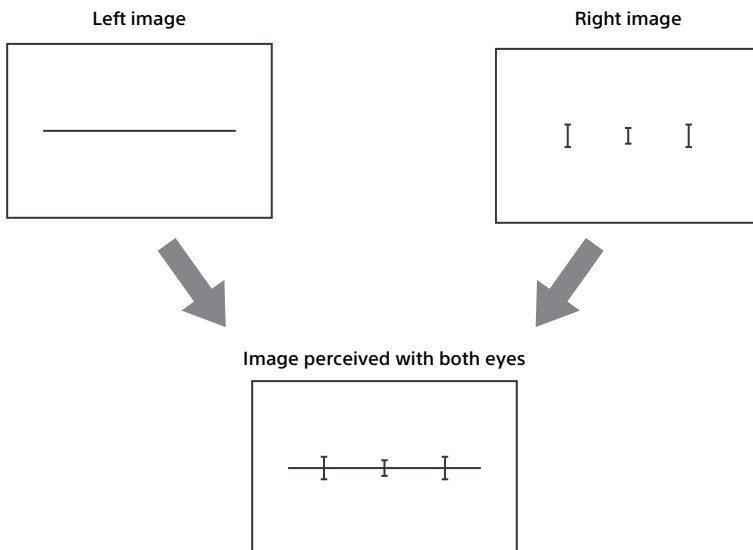

Correct Display

For correct display, slide the lens span adjusters as needed so that all three "I" marks and the horizontal line intersect.

It is acceptable if the "I" marks and the horizontal line intersect in a position other than the center of the screen.

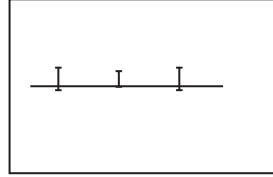
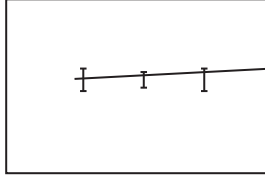
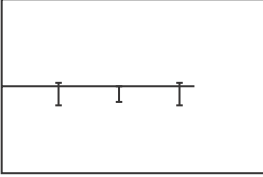

Incorrect Display

If even one of the "I" marks and the horizontal line do not intersect, recheck if you are wearing the head mounted unit correctly, referring to the "Startup Guide." If they still do not intersect, stop using the system. as the head mounted unit may have been bent out of shape, or it may be damaged. If this condition occurs, contact your nearest Sony dealer or local authorized Sony service center.



"I" marks and the horizontal line do not intersect.

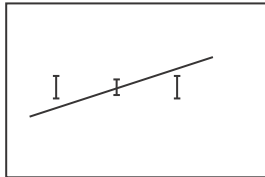

The horizontal line appears to be extremely slanted.

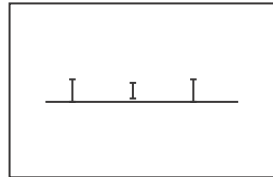

The middle "I" mark does not intersect the horizontal line.

System Settings

Setting menus can be accessed at any time to change or adjust a variety of system settings, such as video picture quality, audio output format, and 3D display format. To view the menus, press the MENU button on the head mounted unit.

Note

- After 90 seconds of inactivity, the setting menu will automatically close.

Tips

- To return to the previous menu, press the ◀ button.
- To exit the setting menu, press the ◀ button in the setting category menu.

Basic Menu Operations

- 1 Press the MENU button on the head mounted unit.

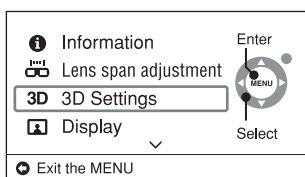

- 2 Press the ▲/▼ button to select the desired setting category, and then press the MENU button.

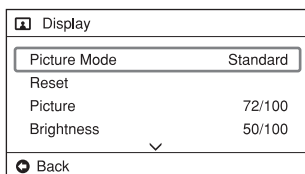

- 3 Press the ▲/▼ button to select the desired menu, and then press the MENU button.



- 4 Press the ▲/▼/◀/▶ button to change or adjust settings as needed, and then press the MENU button to enter your changes.

Menus

Default settings are underlined>.

i Information

Identifies input signals (video and audio signals) from equipment connected to the system and shows various types of information. "Unsupported signal" indicates that the input signal is incompatible with the system, and "No signal" is shown when no signals are input.

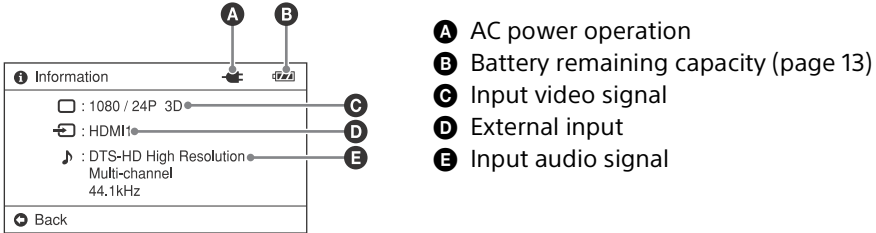

∞ Lens span adjustment

Lens span adjustment	<p>Adjusts the lens span of the head mounted unit to match the distance between your eyes (interpupillary distance), for an optimal viewing experience. Use the lens span adjusters on the head mounted unit for adjustment. For details, refer to the "Startup Guide."</p> <p>Notes</p> <ul style="list-style-type: none">• Without the lens span adjusted correctly, you cannot enjoy an optimal viewing experience. Always adjust the lens span before use.• Audio is muted during adjustment.• The volume cannot be changed during adjustment.
-----------------------------	---

3D 3D Settings

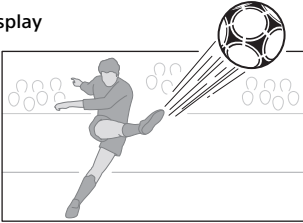
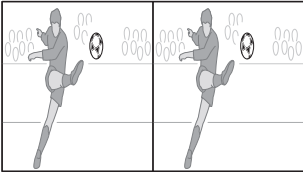
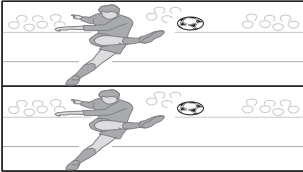
Reset	Resets all “3D Settings” items to the original default values.
3D Display	<p>Manually select the display format for 3D content. Available settings vary depending on whether the source signal includes a 3D format identification signal, as follows.</p> <p>Example of 3D display</p>  <p>For 3D content without a 3D format identification signal</p> <p>Side-by-Side: Select for side-by-side 3D content, with similar images displayed side by side.</p>  <p>Off: Select to display content in 2D format.</p> <p>Over-Under: Select for top-and-bottom 3D content, with similar images displayed on top and bottom.</p>  <p>For 3D content with a 3D format identification signal</p> <p>On: Select to display content in 3D format.</p> <p>Off: Select to display content in 2D format.</p> <p>Notes</p> <ul style="list-style-type: none">• If 3D content is not displayed correctly using the selected settings, try changing “Side-by-Side” to “Over-Under” or vice-versa.• When selecting “Side-by-Side” or “Over-Under,” change the setting to “Off” after viewing 3D content.

<p>Auto 3D</p>	<p>On: Automatically switches to 3D display mode when a 3D format identification signal is detected. If the 3D format identification signal is no longer detected, the system will automatically switch to 2D display mode.</p> <p>Off: Deactivates this function.</p> <p>Note</p> <ul style="list-style-type: none"> • If images do not appear in 3D when “Auto 3D” is set to “On,” try changing the “3D Display” setting.
-----------------------	---

Display

<p>Picture Mode</p> <p>Details of the “Picture Mode” option you choose here can be adjusted in the settings from “Reset” to “Contrast Remaster” below.</p>	<p>Vivid: Vivid colors and sharp contrast, for concerts, sports, and other televised content.</p> <p>Standard: Emphasizes a natural picture. Standard picture quality for a variety of video sources.</p> <p>Cinema: Picture quality designed especially for cinematic content.</p> <p>Custom1/Custom2: Stores your customized preferred picture quality, adjusting from original flat picture.</p> <p>Game1: Picture quality designed for games.</p> <p>Game2: Picture quality for improving visibility of dim scenes of games.</p> <p>Game3: Picture quality for improving visibility of dark scenes of games.</p> <p>Game4: Picture quality for improving visibility of extremely dark scenes of games.</p> <p>Note</p> <ul style="list-style-type: none"> • When “Picture Mode” is set to “Game1” to “Game4,” you can switch over among these modes by pressing ▲, ►, ▼ or ◀ (page 10) during viewing. This operation is not available when the setting menu is displayed.
<p>Reset</p>	<p>Restores all the values (except for values of “Display Size,” “Screen,” “24p True Cinema,” “Cinema Conversion,” “Overscan,” and “Wide Mode” in “Display”) of the selected mode in the “Picture Mode” menu to the default settings when selecting “Yes.”</p>
<p>Picture</p>	<p>Adjusts image contrast.</p>
<p>Brightness</p>	<p>Adjusts the brightness of the image.</p>
<p>Color</p>	<p>Adjusts the color intensity of the image.</p>

<p>Color Temperature</p>	<p>Adjusts image color temperature. Natural: Automatically optimizes color temperature for each "Picture Mode," based on characteristics of human vision. Cool: Cool blue color tones. Medium: Color tones between "Cool" and "Warm 1/Warm 2." Warm 1/Warm 2: Warm red color tones. "Warm 2" is redder than "Warm 1."</p>
<p>Panel Drive Mode</p>	<p>Select the type of display method for image motion. Normal: Standard image appearance. Clear: Reduces blurring of fast-moving images.</p> <p>Notes</p> <ul style="list-style-type: none"> • Although selecting "Clear" reduces blurring of fast-moving images, it also darkens the screen as a whole. If this is distracting, select "Normal." • The screen as a whole may appear to flicker, depending on the source signal. If this is distracting, select "Normal."
<p>Clear Black</p>	<p>Adjusts the appearance of dark image areas to fit the selected "Picture Mode."</p>
<p>Sharpness-Hi</p>	<p>Controls thin edges and fine texture of images to make the images stand out or softer.</p>
<p>Sharpness-Mid</p>	<p>Controls thick edges and rough texture of images to make the images stand out or softer.</p>
<p>Noise Reduction</p>	<p>Reduces random image noise, similar to static. High/Medium/Low: Select the level of this effect. Off: Deactivates this function.</p>
<p>Contrast Remaster</p>	<p>Automatically optimizes black and white levels, for good contrast without faded blacks or whites. High/Medium/Low: Select the level of this effect. Off: Deactivates this function.</p>
<p>Display Size</p>	<p>Selects the image display size. 100%: Displays the image in full-screen. 90%/80%/70%: The display size is reduced to 90%, 80%, or 70%, respectively.</p>
<p>Screen Not available during 3D playback. The setting returns to "Normal" if you perform an adjustment using the "Lens span adjustment" menu (page 23).</p>	<p>Normal: Displays the original image. Theater1: Outputs the image simulated as in a theater, viewed through a curved screen. Theater2: Outputs the image simulated as in a theater with a CinemaScope screen more than "Theater1."</p>

<p>24p True Cinema</p>	<p>On: Displays 24 fps video faithfully at 24 fps. Cinematic content of this kind is available on Blu-ray disc. Provides a viewing experience similar to that in theaters.</p> <p>Off: Deactivates this function. 24 fps video signals are displayed after upconversion to 60 fps.</p> <p>Note</p> <ul style="list-style-type: none"> When "Panel Drive Mode" is set to "Clear," the screen may appear to flicker (depending on the source signal), which may be distracting. In such a case, either deactivate this function or set "Panel Drive Mode" to "Normal."
<p>Cinema Conversion</p>	<p>Auto: The system automatically detects whether you are watching video content (such as TV dramas and animation) or film content (movies) and switches to the corresponding conversion method.</p> <p>Video: The system always displays in a format for video content, whether playing video or film content.</p>
<p>Overscan Not available during 3D playback.</p>	<p>Adjusts the display area.</p> <p>On: Hides image edges. Select in case of issues such as noise at images edges.</p> <p>Off: Displays the entire image.</p>
<p>Wide Mode Not available during 3D playback.</p>	<p>Normal: Displays the images at the original 4:3 aspect ratio.</p> <p>Full: Displays 4:3 content in full-screen, stretching the images horizontally. 16:9 content is also displayed full-screen, at the original aspect ratio.</p> <p>Zoom: Enlarges the images vertically and horizontally, preserving the original aspect ratio.</p> <p>Note</p> <ul style="list-style-type: none"> "Normal" is not available with HD input sources (1080i, 720p, or 1080p).

Sound

Note

- The Sound menu items (except "A/V SYNC") are available only when the processor unit is connected.

Reset	Resets all "Sound" settings to the original default values.
Surround	<p>Standard: Standard acoustic setting, providing a spacious sound stage for a range of content.</p> <p>Cinema: Emphasizes a natural sound stage rivaling the impressive acoustics of movie theaters, especially for spoken dialog. Immersive, with each channel blended naturally. A good choice for movies.</p> <p>Game: Ideal for games. Provides pinpoint sound localization, for a clear sense of where sounds originate. For immersive gameplay in games with multi-channel surround-sound effects. Especially suitable for games that have a multi-channel soundtrack.</p> <p>Music: Emphasizes detail and purity of source audio. Faithful reproduction, similar to monitor equipment at recording studios. A good choice for music.</p> <p>Off: Deactivates surround-sound effects.</p> <p>Note</p> <ul style="list-style-type: none">• Volume may vary depending on the source audio signal and selected surround-sound mode.
Dolby Pro Logic IIx	<p>Selects matrix decoder operation. You can easily enjoy surround effects even when the input signal is in 2 channels, by simply activating the matrix decoder.</p> <p>Movie: Performs Movie-mode processing of Dolby Pro Logic IIx. Suitable for playing movie music with Dolby Surround encoded. Movies dubbed in another language or videos of old movies can be played in 7.1-channel mode.</p> <p>Music: Performs Music-mode processing of Dolby Pro Logic IIx. Suitable for normal stereo sound sources such as CDs.</p> <p>Off: Deactivates the matrix decoder.</p> <p>Note</p> <ul style="list-style-type: none">• "Dolby Pro Logic IIx" is fixed to "Off" if the "DTS Neo:6" setting is not "Off."

<p>DTS Neo:6</p>	<p>Selects matrix decoder operation. You can easily enjoy surround effects even when the input signal is in 2 channels, simply activating the matrix decoder.</p> <p>Cinema: Performs Cinema-mode processing of DTS Neo:6.</p> <p>Music: Performs Music-mode processing of DTS Neo:6.</p> <p>Off: Deactivates the matrix decoder.</p> <p>Note</p> <ul style="list-style-type: none"> • “DTS Neo:6” is fixed at “Off” if the “Dolby Pro Logic IIx” setting is not “Off.”
<p>Treble</p>	<p>Adjusts high-frequency audio output.</p>
<p>Bass</p>	<p>Adjusts low-frequency audio output.</p>
<p>Harmonics Equalizer</p>	<p>On: Retrieves the tail shape of the waveform which would likely be omitted by audio compression algorithms due to its low amplitude.</p> <p>Off: Deactivates this function.</p>
<p>A/V SYNC</p>	<p>Corrects out-of-sync audio and video signals by delaying audio output. Audio output can be delayed in 10-millisecond increments, in a range of 0-100 ms.</p> <p>Note</p> <ul style="list-style-type: none"> • Some out-of-sync audio and video cannot be corrected with this function, depending on the source signal.
<p>Type of Headphones</p>	<p>Switches to the optimal virtual surround-sound setting for the type of headphones used.</p> <p>Inner Ear: Ideal for headphones worn in your ears, such as the supplied headphones.</p> <p>Overhead: Ideal for headphones worn over or on your ears.</p> <p>Note</p> <ul style="list-style-type: none"> • Surround-sound effects may not be produced correctly unless this setting matches the type of headphones used.
<p>Dual Mono Available only with dual mono audio source signals. Not available for linear PCM source signals.</p>	<p>Switches the main or sub audio output for audio source signals other than linear PCM.</p> <p>Main: Both left and right headphone output consists solely of the main audio content.</p> <p>Sub: Both left and right headphone output consists solely of the sub audio content.</p> <p>Main/Sub: Headphone output on one side consists of the main audio content. Output on the other side consists of the sub audio content.</p>

General Setup

<p>Set password</p> <p>Cancel password</p> <p>“Set password” is not available when a password has been set.</p> <p>“Cancel password” is not available when no password has been set.</p>	<p>A password can be set to restrict use of the system. Once a password is specified, it must be entered each time the system is turned on.</p> <p>To cancel password protection, select “Cancel password” and enter the password.</p> <p>Note</p> <ul style="list-style-type: none">• The system automatically turns off in the following situations. Either turn the system on and enter the password again or cancel password protection.<ul style="list-style-type: none">– When the password is entered incorrectly, and you close the displayed setting menu by using the ◀ button– After 90 seconds of inactivity on the password input screen
<p>Input</p> <p>Not available when the processor unit is disconnected.</p>	<p>Selects the input to the processor unit. The signal input to the selected input jack is displayed on the head mounted unit.</p> <p>HDMI1: Input via the HDMI IN 1 jack</p> <p>HDMI2: Input via the HDMI IN 2 jack</p> <p>HDMI3: Input via the HDMI IN 3 jack</p>
<p>HDMI Dynamic Range</p>	<p>Selects the video signal input level.</p> <p>Auto: The system automatically detects the input level. Normally set to “Auto.”</p> <p>Full: Select this option when the highlights in the image are blown out or the shadows are blocked.</p> <p>Limited: Select this option when the highlights in the image are dull or the shadows are outstanding.</p>
<p>HDMI pass-through</p> <p>Not available when the processor unit is disconnected.</p>	<p>On: Activates pass-through, enabling you to watch or listen to content on a TV or other display device when the system is in standby mode. For details, refer to the “Startup Guide.”</p> <p>Off: Deactivates this function. To save power, select “Off” when a TV or other display device is not connected to the processor unit.</p>

<p>Control for HDMI</p>	<p>On: Activates control for HDMI CEC (Consumer Electronic Control)-compatible equipment connected to the system using the ▲/▼/◀/▶ buttons (page 10) on the head mounted unit.</p> <p>▲ button: Starts playback.</p> <p>▼ button: Pauses playback.</p> <p>◀ button: Jumps to the previous chapter. Hold the button down for fast-rewind.</p> <p>▶ button: Jumps to the next chapter. Hold the button down for fast-forward.</p> <p>Off: Deactivates this function. Use the remote control of the connected equipment to control it.</p> <p>Notes</p> <ul style="list-style-type: none"> • If control is not possible with this setting activated, the connected equipment is not compatible with the system's "Control for HDMI" function. Control connected equipment directly. • The connected equipment cannot be controlled when "Picture Mode" is set to "Game1," "Game2," "Game3," or "Game4" (page 25).
<p>Power off when unmounted</p>	<p>On: Turns the system off automatically 20 minutes after you take the head mounted unit off.</p> <p>Off: Deactivates this function.</p> <p>Tip</p> <ul style="list-style-type: none"> • Regardless of this setting, the screens will go off automatically 10 seconds after you remove the head mounted unit.
<p>No signal Standby</p>	<p>On: Turns the system off automatically when 30 minutes elapse without signal input.</p> <p>Off: Deactivates this function.</p>
<p>Language setting</p>	<p>Sets the language used for menus and other interface elements.</p> <p>Notes</p> <ul style="list-style-type: none"> • Audio is muted while this setting is configured. • The volume cannot be adjusted while this setting is configured.
<p>Menu Display</p>	<p>3D: Displays the menu in 3D format.</p> <p>2D: Deactivates the 3D format of the menu display.</p>

<p>Prolonged viewing warning</p>	<p>On: Activates automatic display of a warning about whether to turn the power off after 3 hours of continuous viewing. Selecting “Yes” on the warning screen will turn the power off. Selecting “No” will cause the power to be turned off 3 hours later, after 6 hours of continuous viewing.</p> <p>Off: Deactivates this function.</p> <p>Note</p> <ul style="list-style-type: none"> • When the warning is displayed after 3 hours of viewing, if no response is made in 90 seconds, the power will automatically be turned off.
<p>Startup viewer warning</p>	<p>On: Activates automatic display of a startup warning.</p> <p>Off: Deactivates this function.</p>
<p>Reset to factory settings</p>	<p>Resets all settings to the original default values.</p> <p>Note</p> <ul style="list-style-type: none"> • The password set in “Set password” (in “General Setup”) will also be cleared.

Troubleshooting

If the following symptoms occur when using the system, check the cause and action before requesting service. If the issue persists, contact your Sony dealer or local authorized Sony service center.

For the troubles with video or audio, see through the multiple sections below.

- **Troubles with video** → **A** Frequently Asked Question, **C** Audio/Video (in common), or **D** Video
- **Troubles with audio** → **A** Frequently Asked Question, **C** Audio/Video (in common), or **E** Audio

A Frequently Asked Question

FAQ No video or audio. No 3D image.

- 1 Turn the power of this system on.
- 2 Turn off the playback equipment, and turn it on again.
 - When PlayStation®3 is used with this system, turn off the PlayStation®3, and then turn it on again by pressing its power button for at least 5 seconds until you hear a beep sound twice. (If the PlayStation®3 is connected via an AV amplifier, also turn off the amplifier and turn it on again.)

Troubles with 3D display

The same image is displayed side by side or top and bottom.

- The 3D display format setting may be incorrect. Try changing the “3D Display” setting in “3D Settings” (page 24).

The image is not shown in 3D.

- Check the settings on the playback equipment. Refer also the Operation Manual of that equipment.

FAQ Video or audio of the playback equipment cannot be viewed on the TV connected via the HDMI OUT (TV) jack of the processor unit.

- 1 Make sure that the “HDMI pass-through” setting in “General Setup” is set to “On” (page 30).
- 2 Turn off the power of this system then set it to standby mode.
 - The HDMI pass-through function is enabled only when the “HDMI pass-through” setting is set to “On,” then the system is turned off.
 - Simultaneous viewing on this system and the TV is not possible.
- 3 Turn off the playback equipment, and turn it on again.
 - If the playback equipment is a PlayStation®3, hold down the power button on the PlayStation®3 for at least 5 seconds until you hear a beep sound twice to turn it on again.

FAQ The “I” marks and the horizontal line do not intersect on the confirmation screen that appears when the system is turned on.

- 1 Adjust the length and position of the headbands, referring to “For a Comfortable Fit” and “2 Adjust and Wear” in the “Startup Guide.”
- 2 Adjust the lens span while checking the display. Refer to “3 Setup and View” in the “Startup Guide.”
 - If no “I” mark intersects with the horizontal line after performing actions 1 and 2, check on “Confirming Screen Alignment” (page 20).

B Power Supply

Symptom	Cause/Action
The system does not turn on	<ul style="list-style-type: none"> → Confirm that the AC adaptor is connected properly, referring to the “Startup Guide.” → Confirm that the battery is charged (page 13). → Hold down the ⏻ (Power On/Standby) button on the head mounted unit for at least one second.
The system does not go off	<ul style="list-style-type: none"> → Hold down the ⏻ (Power On/Standby) button on the head mounted unit for at least one second.

C Audio/Video (in common)

Symptom	Cause/Action
No audio or video, or audio or video is distorted	<ul style="list-style-type: none"> → Refer to the “Startup Guide” and confirm that the AC adaptor and HDMI cable are connected correctly. → Make sure that equipment connected to the HDMI IN jack on the processor unit is on. → Make sure that equipment from which you wish to view is selected correctly with the INPUT button on the processor unit when the processor unit is used. → Confirm that the input signal is supported with this system. For available signals, see “Video input” and “Audio input” of “Specifications” (page 41). If the input signal is not supported with this system, check the video output and/or audio output settings on the connected equipment. → Confirm that the HDMI cable is firmly plugged in. If video quality does not improve, the HDMI cable may be damaged. In that case, try a new cable. → If equipment is connected to the processor unit via an AV amplifier (receiver), try connecting the equipment directly to the processor unit instead. For details, refer to the instruction manual of the equipment used. → Use either the supplied HDMI cable or a commercially available HDMI cable identified as a High-Speed cable. → Also check section D Video, or E Audio.

D Video

Symptom	Cause/Action
<p>No video, or output video is distorted</p>	<ul style="list-style-type: none"> → When selecting “Side-by-Side” or “Over-Under” in “3D Display” (in “3D Settings”), change the setting to “Off” after viewing 3D content (page 24). → Make sure to disable video output with the Deep Color signal on the connected equipment. If this option is not available on the equipment and the content is being output at 1080FP (Frame Packing), change the resolution to 720FP. → Also check section C Audio/Video (in common).
<p>The screen is dark or blurry</p>	<ul style="list-style-type: none"> → Refer to the “Startup Guide” and confirm that the AC adaptor and HDMI cable are connected correctly, and that you are wearing the head mounted unit correctly. → The lens span may have been adjusted incorrectly (page 21). Perform adjustment again by accessing “Lens span adjustment” in the setting menu (page 23). → If the lenses in the head mounted unit are dirty, wipe them with a soft dry cloth to clean them.
<p>A bright portion of an image is too bright, or a dark portion of an image is too dark</p>	<ul style="list-style-type: none"> → The phenomenon may appear when the RGB signal level of the input signal is beyond the level specified by the HDMI standards. Adjust the RGB signal output level on the connected equipment or change the “HDMI Dynamic Range” setting of this system (page 30). → Check the “Picture Mode” setting and change it to an appropriate mode (page 25).
<p>The screens suddenly go off</p>	<ul style="list-style-type: none"> → After 3 hours of continuous viewing, the system will display a warning screen and go off after 90 seconds of inactivity. If you clear the message and continue watching, the system will automatically go off after another 3 hours to encourage healthy viewing habits. For details, see “Prolonged viewing warning” (page 32). → Wear the head mounted unit correctly. 10 seconds after the sensor in the head mounted unit detects that you have removed the unit, the displayed screen will automatically go off. For details, see “Power off when unmounted” (page 31). → The system will be turned off automatically if 30 minutes elapse without signal input when “No signal Standby” is set to “On” (page 31).
<p>Image display dims over time</p>	<ul style="list-style-type: none"> → Although image display of photos or nearly motionless images may dim over time, this does not indicate system damage. To restore normal brightness, perform some operation on the head mounted unit or the connected equipment directly.

Symptom	Cause/Action
<p>Some pixels on the screens are not lit, or some pixels are always lit</p>	<p>→ The panel fitted to this system is manufactured with high-precision technology, giving a functioning pixel rate of at least 99.99%. Thus, a very small proportion of pixels may be “stuck”, either always off (black), always on (red, green, or blue), or flashing. This phenomenon occurs owing to the structure of this system and does not indicate a malfunction. Sony is not liable for replacement or return of the system because of that phenomenon.</p> <div data-bbox="831 145 1003 276" data-label="Image"> </div> <p>Always-lit, or unlit pixel</p>
<p>Some scenes on a Blu-ray disc recorded at 24 fps (matching the original movie) look unnatural</p>	<p>→ In this case, try activating “24p True Cinema.” For details, see “24p True Cinema” (page 27).</p>
<p>The screen flickers</p>	<p>→ Some source signals may cause the screen as a whole to appear to flicker when “Panel Drive Mode” is set to “Clear,” or when “24p True Cinema” is activated. For details, see “Panel Drive Mode” (page 26) and “24p True Cinema” (page 27).</p>
<p>Video is not shown in 3D</p>	<p>→ If the same image is displayed side by side or on top and bottom, the 3D display format setting may be incorrect. Try changing the “3D Display” setting in “3D Settings” (page 24).</p> <p>→ 3D perception varies by viewer.</p> <p>→ If the “3D Settings” menu is displayed but images are not shown in 3D, try restarting the connected equipment used for 3D playback.</p> <p>→ The system does not support 2D to 3D conversion (simulated 3D).</p> <p>→ Viewing anaglyphic images in 3D requires anaglyphic glasses (with red and blue lenses, for example).</p> <p>→ Also check the settings of playback equipment connected to the processor unit.</p>
<p>3D display is not activated automatically</p>	<p>→ Make sure the “Auto 3D” setting in “3D Settings” is set to “On” (page 25).</p> <p>→ 3D content without a 3D format identification signal is not automatically displayed in 3D. Try changing the “3D Display” setting in “3D Settings” to “Side-by-Side” or “Over-Under” (page 24).</p>

E Audio

Symptom	Cause/Action
<p>There is no sound / There is static / Volume cannot be increased</p>	<ul style="list-style-type: none"> → Adjust the volume using the VOL +/- buttons on the head mounted unit. → Insert the headphone plug securely (Refer to “1 Connect” in the “Startup Guide.”). The playback sound may not be heard correctly if the headphone connection is wrong. → The headphone plug is dirty. Clean the headphone plug with a soft dry cloth. → When the system is connected to HDMI CEC-compatible home theater systems or AV amplifiers (receivers), check the following settings. <ul style="list-style-type: none"> – Make sure the “Control for HDMI” setting in “General Setup” is set to “On” (page 31). – Make sure “Control for HDMI” is activated on the AV amplifier (receiver) or other equipment. For details, refer to the instruction manual of the equipment used. → When the headphone jack on the processor unit is used, there is a slight delay in volume change in response to volume adjustment. → Also check section C Audio/Video (in common).
<p>There is no surround-sound effect</p>	<ul style="list-style-type: none"> → Make sure the “Surround” setting in “Sound” is not set to “Off” (page 28). → Make sure the “Type of Headphones” setting in “Sound” is correct for the type of headphones in use (page 29). → Sound perception varies by listener.
<p>There is no bass</p>	<ul style="list-style-type: none"> → Make sure that the earbuds fit snugly in your ears (page 18).
<p>Audio signals are not input in a “codec” audio format*</p> <p>* The “codec” audio format represents the audio formats other than linear PCM that are described in “Audio input” of “Specifications” (page 42).</p>	<ul style="list-style-type: none"> → The playback equipment may be configured to convert audio output signals of a “codec” audio format to linear PCM signals. In that case, in the playback equipment settings, disable “codec” audio format conversion then resume playback. For details, refer to the instruction manual of the equipment used.
<p>Audio playback is not in the right format</p>	<ul style="list-style-type: none"> → For dual mono audio, change the “Dual Mono” setting in “Sound” (page 29). For other audio formats, check the settings of connected equipment.

F Charging

Symptom	Cause/Action
Charging cannot be performed Charging time is extended	<ul style="list-style-type: none"> → Make sure that the AC adaptor and AC power cord are firmly connected. → Charging may not be performed in excessively cold or hot places. Perform charging under temperatures from 5 °C to 35 °C (41 °F to 95 °F). → Longer charging time is required if you charge with the system turned on. Turn off the system before charging. → The battery may be deteriorated if the system has not been used in more than one year. Contact your Sony dealer or local authorized Sony service center.

G HDMI Control

Symptom	Cause/Action
Connected equipment cannot be controlled using the buttons on the head mounted unit	<ul style="list-style-type: none"> → Make sure the "Control for HDMI" setting in "General Setup" is set to "On" (page 31). → Make sure the connected equipment supports the HDMI CEC functions. → Make sure "Control for HDMI" setting of the connected equipment is configured correctly. For details, refer to the instruction manual of the equipment used. → The connected AV amplifier (receiver) may not be compatible with the system's "Control for HDMI" function. "Control for HDMI" function will not work correctly in this case. → Controlling connected equipment by pressing buttons on the head mounted unit may not be possible immediately after turning the system on, or immediately after activating "Control for HDMI" in "General Setup." → Controlling connected equipment is not possible when "Picture Mode" is set to "Game1," "Game2," "Game3", or "Game4" (page 25).

H Other Issues

Symptom	Cause/Action
"Control for HDMI" on a TV cannot be used to control the playback equipment even when the system's HDMI pass-through is used	<ul style="list-style-type: none"> → Refer to the instruction manual supplied with your TV, and in the TV's "Control for HDMI" setting, specify playback equipment connected to the processor unit as the controlling device.
Head mounted unit buttons are unresponsive	<ul style="list-style-type: none"> → Buttons on the head mounted unit do not function unless you are wearing it.

Symptom	Cause/Action
“DEMO” appears in the upper-right corner of the setting menu screen	→ Contact your Sony dealer or local authorized Sony service center.
Cannot adjust “Language setting” because the setting menu is in an unfamiliar language	<p>→ If initial setup is not finished, press the ◀ button repeatedly to return to the language selection screen, and then select your preferred language again.</p> <p>→ If you have finished initial setup, follow these steps to restore the system to the original, factory settings and specify the correct language.</p> <ol style="list-style-type: none"> 1 Press the MENU button to display the setting menus. 2 Press the ▼ button, select “ General Setup,” and then press the MENU button. 3 Press the ▼ button and move the cursor to the bottom setting. 4 Press the MENU button. (A “Reset to factory settings” confirmation message is displayed.) 5 Press the ◀ button, and then press the MENU button. (The system will restart.) 6 After the initial setting screen is displayed, press the ▲/▼ buttons to select your preferred language, and then press the ► button. 7 Follow the instructions displayed to finish initial setup.
Discomfort in the nose or forehead from contact with the head mounted unit	→ Adjust the position of the forehead supporter forward or downward (page 15).

Warning by the indicators

The indicators on the battery unit and processor unit alert unusual conditions of the system.

	Indication	Error/Action
Battery unit		
⏻ (power) indicator (orange)	Repeats flashing twice every 3 seconds	Contact your Sony dealer or local authorized Sony service center. The battery unit may be damaged.
	Repeats flashing three times every 3 seconds	Temperature error in the battery unit. Leave the unit for a while. Flashing stops when the unit cools off. Use the battery unit in a well-ventilated location to prevent blocking of the ventilation slots.
	Repeats flashing five times every 3 seconds	Battery error. Stop using the system and contact your Sony dealer or local authorized Sony service center.
Processor unit		
POWER indicator (red)	Repeats flashing twice every 3 seconds	Contact your Sony dealer or local authorized Sony service center. The processor unit may be damaged.
	Repeats flashing three times every 3 seconds	Temperature error in the processor unit. Leave the unit for a while. Flashing stops when the unit cools off. Use the processor unit in a well-ventilated location to prevent blocking the ventilation slots.

Specifications

Power requirement

Processor unit:

DC IN jack 8.4 V

Head mounted unit and battery unit:

Micro USB jack (for charging)

5 V DC

Power consumption

Processor unit:

4.0 W (in operation)

0.4 W (in standby mode)

2.0 W (in HDMI pass-through mode)

Head mounted unit and battery unit:

11 W (during charging)

Battery charging time

Head mounted unit and battery unit:

Approx. 4.5 hours (in standby mode at 23 °C (74 °F))

Approx. 5.5 hours (in operation at 23 °C (74 °F))

Battery operating time

Head mounted unit and battery unit:

Approx. 7 hours (in operation at 23 °C (74 °F))

Approx. 3 hours (in MHL operation at 23 °C (74 °F))

Operating temperature

5 °C to 35 °C (41 °F to 95 °F)

Operating humidity

25 % to 80 %

Dimensions (W×H×D, including largest protrusions)

Processor unit:

Approx. 150 mm × 31 mm × 107 mm

(6 in. × 1 1/4 in. × 4 1/4 in.)

Head mounted unit:

Approx. 189 mm × 148 mm × 270 mm

(7 1/2 in. × 5 7/8 in. × 10 3/4 in.) (excluding top headband, and bottom headband length adjusted in the center)

Battery unit:

Approx. 80 mm × 26 mm × 119 mm

(3 1/4 in. × 1 1/16 in. × 4 3/4 in.)

Mass

Processor unit:

Approx. 220 g (7.8 oz) (excluding connecting cables)

Head mounted unit:

Approx. 320 g (12 oz) (including top light blockers, and excluding connecting cords)

Battery unit:

Approx. 160 g (5.7 oz) (excluding connecting cord)

Display resolution

1,280 dots (horizontal) × 720 dots (vertical)

Interpupillary distance

53.0 mm – 76.7 mm

(2 1/8 in. – 3 1/8 in.)

Input and output connectors

Processor unit:

HDMI IN 1:

19-pin standard connector

HDMI IN 2:

19-pin standard connector

HDMI IN 3:

19-pin standard connector

HDMI OUT (TV)*:

19-pin standard connector

HDMI OUT (HMD):

19-pin standard connector (on front panel)

Headphone jack:
Stereo phone jack
Head mounted unit:
Headphone jack:
Stereo minijack

Battery unit:
HDMI IN/MHL:
19-pin standard connector
MHL 1 supported
MHL: 5 V, 500 mA power
supply capacity

* When HDMI pass-through is activated, signals supplied to the processor unit are passed through the processor unit to the HDMI output. However, the following signals are not compatible with pass-through.

- Video signals at 4k resolution (at a high resolution exceeding 3,840 (horizontal) × 2,160 (vertical) pixels)

Video input

Video input (2D formats):
480/60p, 576/50p, 720/24p, 720/50p, 720/60p, 1080/50i, 1080/60i, 1080/24p, 1080/50p¹⁾, 1080/60p¹⁾

Video input (3D formats: Frame Packing, Side-by-Side and Top-and-Bottom formats):
720/50p¹⁾, 720/60p¹⁾, 1080/50i²⁾, 1080/60i²⁾, 1080/24p¹⁾, 1080/50p³⁾, 1080/60p³⁾

Audio input

Battery unit:
Linear PCM (2-channel):
32/44.1/48 kHz

Processor Unit:
Linear PCM (2-channel):
Up to 192 kHz
Linear PCM (multi-channel)
MPEG-2 AAC
Dolby Digital
Dolby Digital EX
Dolby Digital Plus
Dolby TrueHD
DTS
DTS-ES
DTS 96/24
DTS-HD Master Audio
DTS-HD High Resolution Audio
DTS-HD LBR

- 1) not available for MHL input
- 2) not available for MHL input, and Frame Packing and Top-and-Bottom formats
- 3) not available for MHL input and Frame Packing format

Headphones

Frequency response:
5 Hz - 24,000 Hz
Impedance:
16 Ω (1 kHz)

AC adaptor AC-UD10 (for the head mounted unit and battery unit)

Rated input
100 V – 240 V AC, 50 Hz/60 Hz,
0.2 A
Rated output
5 V DC, 1.5 A
Operating temperature
0 °C to 40 °C (32 °F to 104 °F)
Storage temperature
–20 °C to +60 °C (–4 °F to 140 °F)
Dimensions (W × H × D)
Approx. 78 mm × 22 mm ×
36 mm
(3 1/8 in. × 7/8 in. × 1 7/16 in.)
Mass
Approx. 45 g (1.6 oz)

AC adaptor AC-L200D (for the processor unit)

Rated input
100 V – 240 V AC, 50 Hz/60 Hz,
0.35 A – 0.18 A
Rated output
8.4 V DC, 1.7 A
Operating temperature
0 °C to 40 °C (32 °F to 104 °F)
Storage temperature
–20 °C to +60 °C (–4 °F to 140 °F)
Dimensions (W × H × D)
Approx. 48 mm × 29 mm ×
81 mm
(1 15/16 in. × 1 3/16 in. × 3 1/4 in.)
Mass
Approx. 170 g (6 oz)

Supplied accessories

See “Supplied Accessories” (page 9).

System specifications and appearance are subject to change for improvement without notice.

Technology Used in This System

- The processor unit enables the user to hear immersive multi-channel virtual surround-sound with depth, produced by the headphones and 7.1-channel Virtualphones Technology (“VPT”).
- More immersive game play with accurate sound localization can be enjoyed by listening in Game mode, which produces a sound stage specifically designed for games with multi-channel surround-sound effects. Game mode sound stage design for this system was supervised by sound designers at Sony Computer Entertainment.

Trademarks

- The terms HDMI™ and HDMI High-Definition Multimedia Interface, and the HDMI Logo are trademarks or registered trademarks of HDMI Licensing LLC in the United States and other countries.

HDMI

- MHL™, Mobile High-Definition Link and the MHL Logo are trademarks or registered trademarks of MHL Licensing, LLC.



- Manufactured under license from Dolby Laboratories. Dolby, Pro Logic, and the double-D symbol are trademarks of Dolby Laboratories.
- For DTS patents, see <http://patents.dts.com>. Manufactured under license from DTS Licensing Limited. DTS, DTS-HD, the Symbol, & DTS and the Symbol together are registered trademarks of DTS, Inc. © DTS, Inc. All Rights Reserved.
- “PlayStation” is a registered trademark of Sony Computer Entertainment Inc. Also, “PS3” is a trademark of the same company.
- “VPT,” Virtualphones Technology is a trademark of Sony Corporation.
- Other system and product names are generally trademarks or registered trademarks of the manufacturers. ™ and ® marks are not indicated in this document.

<http://www.sony.net/>

Printed using VOC (Volatile Organic
Compound)-free vegetable oil
based ink.

© 2013 Sony Corporation Printed in Japan

4-471-978-**E1**(1)